



2 0 2 3 C A B I N E T & A R C H I T E C T U R A L H A R D W A R E

OMNIA

MANUFACTURERS OF FINE LOCKSETS & ARCHITECTURAL HARDWARE

Suggested Retail Prices Effective January 3, 2023

Table of Contents

| SECTION | PAGE |
|----------------------------------------------------------------------|-----------|
| Finishes Chart | 3 |
| CABINET/APPLIANCE PULLS & KNOBS • SOLID BRASS & GLASS | |
| Elite | 4-5 |
| Ultima III | 6-8 |
| Ultima Knobs | 9 |
| Ultima II | 10-12 |
| Ultima I | 13-15 |
| Traditions | 16-17 |
| Prodigy | 17 |
| CABINET/APPLIANCE PULLS & KNOBS • STAINLESS STEEL | |
| Cabinet Pulls | 18-20 |
| Cabinet Knobs | 21 |
| CABINET KNOBS & PULLS • SOLID BRASS | |
| Legacy | 22 |
| Ornate | 23 |
| ALL DOOR PULLS/APPLIANCE PULLS | |
| Stainless Steel | 24 |
| Elite | 24 |
| Traditions | 25 |
| Ultima I | 25 |
| Ultima II | 26 |
| Ultima III | 27 |
| MISC. ARCHITECTURAL HARDWARE | |
| Flushcups • Solid Brass & Stainless Steel | 28-29 |
| Door Stops & Ball Catch • Solid Brass & Stainless Steel | 30 |
| Latch & Decorative Hooks • Solid Brass | 31 |
| Switchplates • Solid Brass | 32-34 |
| OMNIA TERMS & CONDITIONS | 35 |

The story of OMNIA began over fifty-five years ago when our company's founder, Alberto R. Comini came to this country with a vision to introduce to the U.S. market beautifully designed and crafted Italian architectural hardware. To this day, OMNIA has steadfast ties to Italy and while now helmed by the next generation of Comini family members, we continue to stay true to our founding principle of forging our own path.

It is all the people behind the products that make up the OMNIA family including our fiercely loyal employees and our customers with whom we have fostered long-standing relationships. As our business grows, so does our family tree and new opportunities are greeted with Italian hospitality and warmth.

Over the course of our history, OMNIA has built a legacy upon developing products innovative in both design and technological advancement. Our focus is always on what lies ahead and we constantly challenge ourselves to stay in the forefront of our industry. This latest presentation showcases our current product offerings shown with suggested retail prices.

Our products are meticulously fabricated from the finest brass materials or premium-grade stainless steel in order to meet the exceptional standards of the finished project of your dreams. Choose the hardware that is expressly YOU and come to know the look and feel of OMNIA.



OMNIA Finishes

Always check each item number to make sure a finish is available for a particular design.

| | Code | Description | | Code | Description |
|-------------------------------------------------------------------------------------|-------|------------------------------|-------------------------------------------------------------------------------------|-------|------------------------------------|
|  | US3 | POLISHED BRASS, LACQUERED |  | US14 | POLISHED, NICKEL PLATED, LACQUERED |
|  | US3A | POLISHED BRASS, UNLACQUERED |  | US15 | SATIN, NICKEL PLATED, LACQUERED |
|  | US4 | SATIN BRASS, LACQUERED |  | US26 | POLISHED CHROME PLATED |
|  | US5 | ANTIQUE BRASS, LACQUERED |  | US32D | SATIN STAINLESS STEEL |
|  | US10B | BLACK, OIL-RUBBED, LACQUERED | | | |

Additional Finishes

(Only available on certain items)

| | | | |
|-----------------------------------------------------------------------------------------------------------------------|-------------------------------------------------------------------------------------------------------------------------|---------------------------------------------------------------------------------------------------------------------------|---------------------------------------------------------------------------------------------------------------------|
|  US15A PEWTER, LACQUERED |  US26D SATIN CHROME PLATED |  SB SHADED BRONZE, LACQUERED |  VB VINTAGE BRASS |
|  VC VINTAGE COPPER |  VI VINTAGE IRON |  PBL PVD BLACK |  PDB PVD DARK BRONZE |
|  PSG PVD SATIN GOLD |  PTT PVD TITANIUM | | |

ELITE

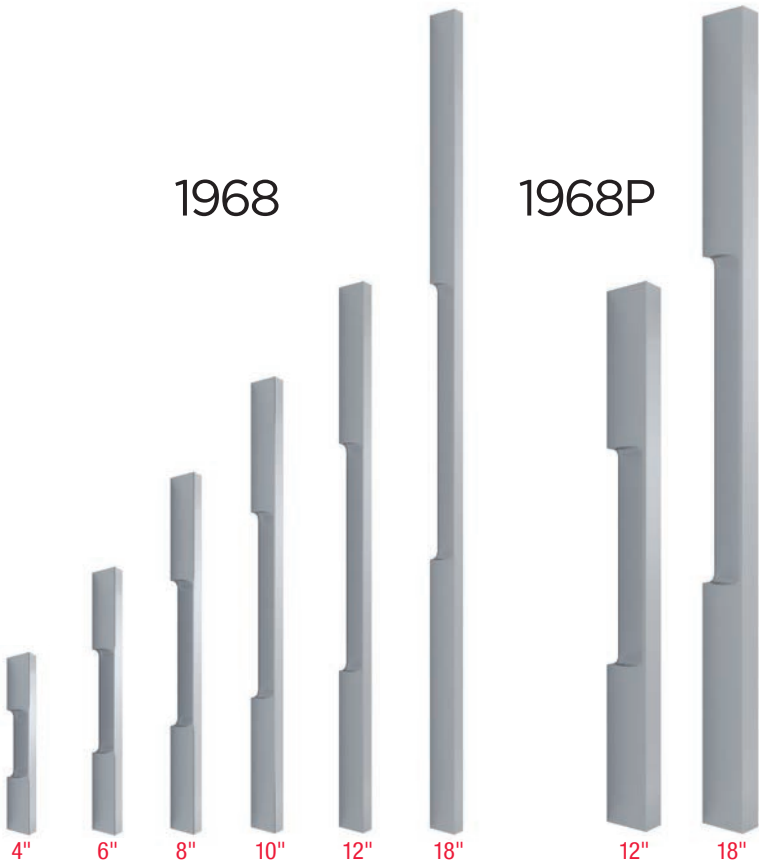

| Item# | Center to Center | Overall Length | Proj. | FINISHES | | |
|--------------------------------------------|------------------|----------------|-----------|---------------------|----------------------|---------------|
| | | | | US4 US14 US26 | US5 US10B US15 | US10B US15 |
| 1968 Cabinet Pull 5/16" W | 1968/102 | 4" | 4 1/2" | 1 1/16" | \$40 | \$45 |
| | 1968/153 | 6" | 6 1/2" | | 45 | 52 |
| | 1968/203 | 8" | 8 1/2" | | 54 | 60 |
| | 1968/254 | 10" | 10 1/2" | | 57 | 67 |
| | 1968/305 | 12" | 12 1/2" | | 69 | 78 |
| | 1968/457 | 18" | 18 1/2" | | 80 | 90 |
| 1968P Appliance Pull 19/32" W | 1968P/305 | 12" | 12 15/16" | 1 3/16" | \$203 | \$215 |
| | 1968P/305BB* | 12" | 12 15/16" | | 203 | 215 |
| | 1968P/457 | 18" | 18 15/16" | | 261 | 272 |
| | 1968P/457BB* | 18" | 18 15/16" | | 261 | 272 |

*In order to achieve back-to-back, order one regular pull and one BB.

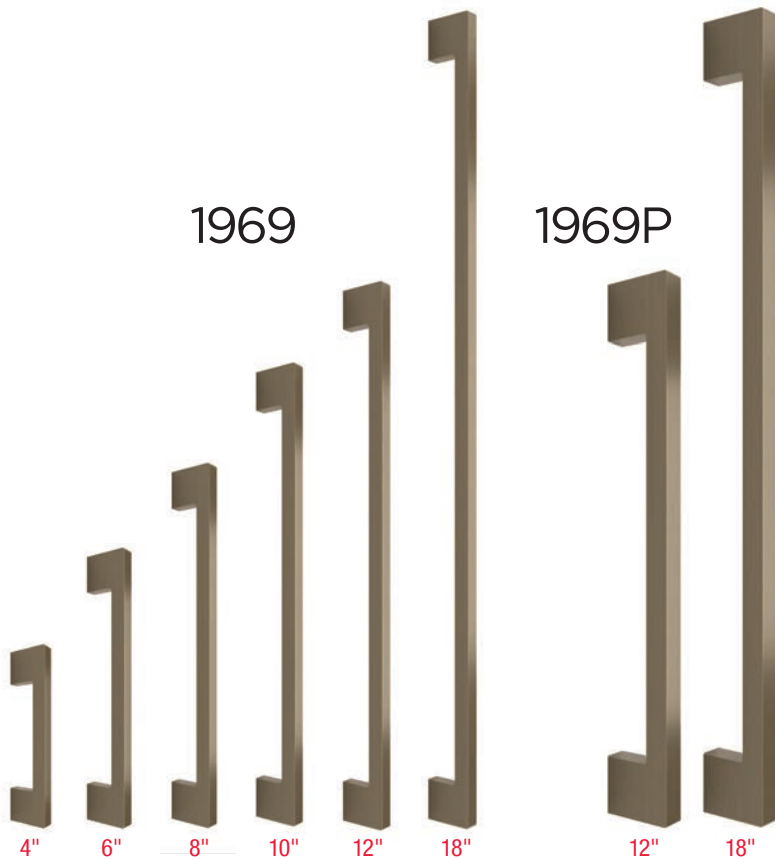

| Item# | Center to Center | Overall Length | Proj. | FINISHES | | |
|--------------------------------------------|------------------|----------------|-----------|---------------------|----------------------|---------------|
| | | | | US4 US14 US26 | US5 US10B US15 | US10B US15 |
| 1969 Cabinet Pull 5/16" W | 1969/102 | 4" | 4 15/16" | 1 3/16" | \$50 | \$54 |
| | 1969/153 | 6" | 6 15/16" | | 60 | 66 |
| | 1969/203 | 8" | 8 15/16" | | 69 | 80 |
| | 1969/254 | 10" | 10 15/16" | | 79 | 87 |
| | 1969/305 | 12" | 12 15/16" | | 90 | 100 |
| | 1969/457 | 18" | 18 15/16" | | 120 | 128 |
| 1969P Appliance Pull 19/32" W | 1969P/305 | 12" | 13 1/8" | 1 3/4" | \$220 | \$229 |
| | 1969P/305BB* | 12" | 13 1/8" | | 220 | 229 |
| | 1969P/457 | 18" | 19 1/8" | | 272 | 278 |
| | 1969P/457BB* | 18" | 19 1/8" | | 272 | 278 |

*In order to achieve back-to-back, order one regular pull and one BB.

Suggested retail prices effective January 3, 2023.

ELITE

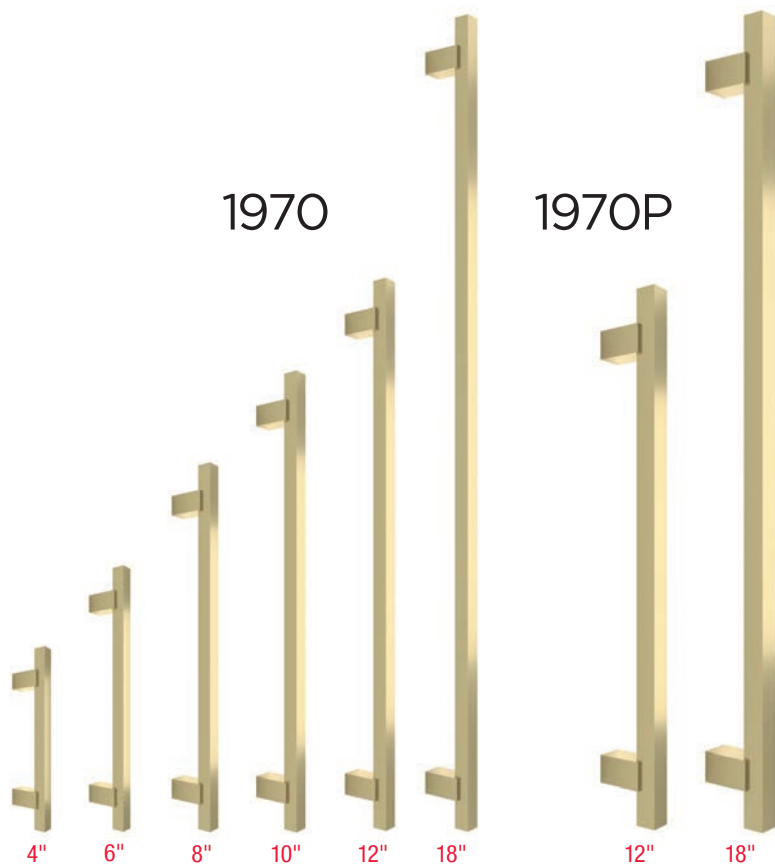

| Item# | Center to Center | Overall Length | Proj. | FINISHES | | |
|-------------------------------------|------------------|------------------------------------|---------------------------------|---------------------|----------------------|---------------|
| | | | | US4 US14 US26 | US5 US10B US15 | US10B US15 |
| 1970 | | | | | | |
| Cabinet Pull | | | | | | |
| 1970/102 | 4" | 5 ¹⁵ / ₁₆ " | 1 ¹ / ₄ " | \$72 | \$78 | |
| 1970/153 | 6" | 7 ¹⁵ / ₁₆ " | | 76 | 88 | |
| 1970/203 | 8" | 9 ¹⁵ / ₁₆ " | | 80 | 96 | |
| 9 ⁹ / ₁₆ " W | 10" | 11 ¹⁵ / ₁₆ " | | 84 | 101 | |
| 1970/305 | 12" | 13 ¹⁵ / ₁₆ " | | 90 | 110 | |
| 1970/457 | 18" | 19 ¹⁵ / ₁₆ " | | 99 | 114 | |
| 1970P | | | | | | |
| Appliance Pull | | | | | | |
| 1970P/305 | 12" | 14 ³ / ₄ " | 1 ³ / ₄ " | \$220 | \$229 | |
| 1970P/305BB* | 12" | 14 ³ / ₄ " | | 220 | 229 | |
| 1970P/457 | 18" | 20 ³ / ₄ " | | 272 | 278 | |
| 1 ¹³ / ₁₆ " W | 1970P/457BB* | 18" | | 272 | 278 | |

*In order to achieve back-to-back, order one regular pull and one BB.

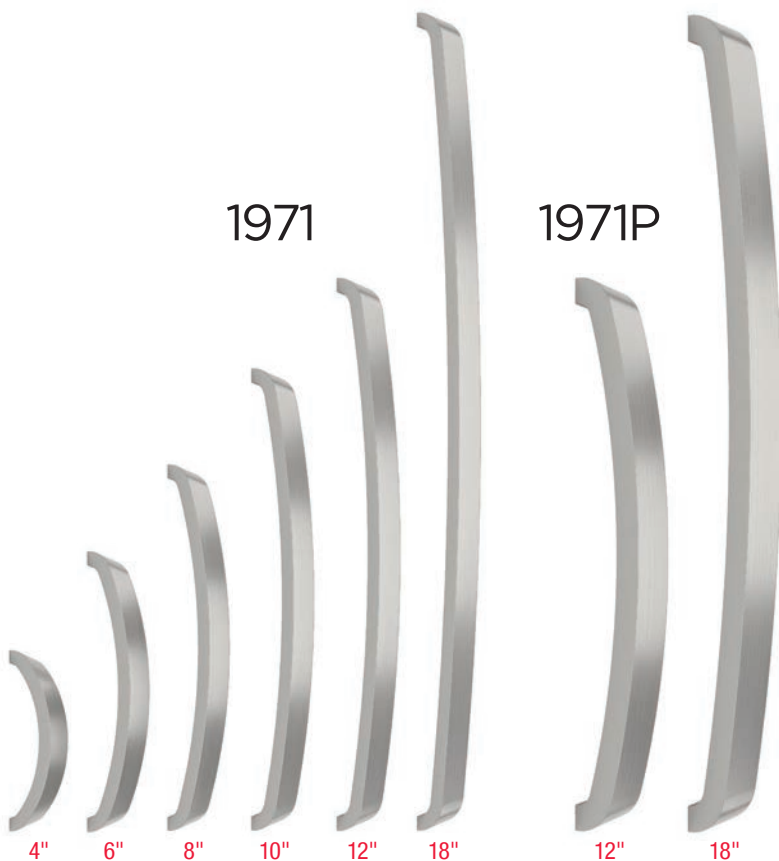

| Item# | Center to Center | Overall Length | Proj. | FINISHES | | |
|-------------------------------------|------------------|------------------------------------|----------------------------------|---------------------|----------------------|---------------|
| | | | | US4 US14 US26 | US5 US10B US15 | US10B US15 |
| 1971 | | | | | | |
| Cabinet Pull | | | | | | |
| 1971/102 | 4" | 4 ³ / ₈ " | 1 ³ / ₁₆ " | \$40 | \$45 | |
| 1971/153 | 6" | 6 ³ / ₈ " | | 45 | 52 | |
| 1971/203 | 8" | 8 ³ / ₈ " | | 54 | 60 | |
| 3 ³ / ₄ " W | 10" | 10 ³ / ₈ " | | 57 | 67 | |
| 1971/305 | 12" | 12 ³ / ₈ " | | 69 | 78 | |
| 1971/457 | 18" | 18 ³ / ₈ " | | 80 | 91 | |
| 1971P | | | | | | |
| Appliance Pull | | | | | | |
| 1971P/305 | 12" | 12 ¹¹ / ₁₆ " | 1 ³ / ₄ " | \$203 | \$215 | |
| 1971P/305BB* | 12" | 12 ¹¹ / ₁₆ " | | 203 | 215 | |
| 1971P/457 | 18" | 18 ⁹ / ₁₆ " | | 261 | 272 | |
| 1 ¹³ / ₁₆ " W | 1971P/457BB* | 18" | | 261 | 272 | |

*In order to achieve back-to-back, order one regular pull and one BB.

Suggested retail prices effective January 3, 2023.

Ultima III

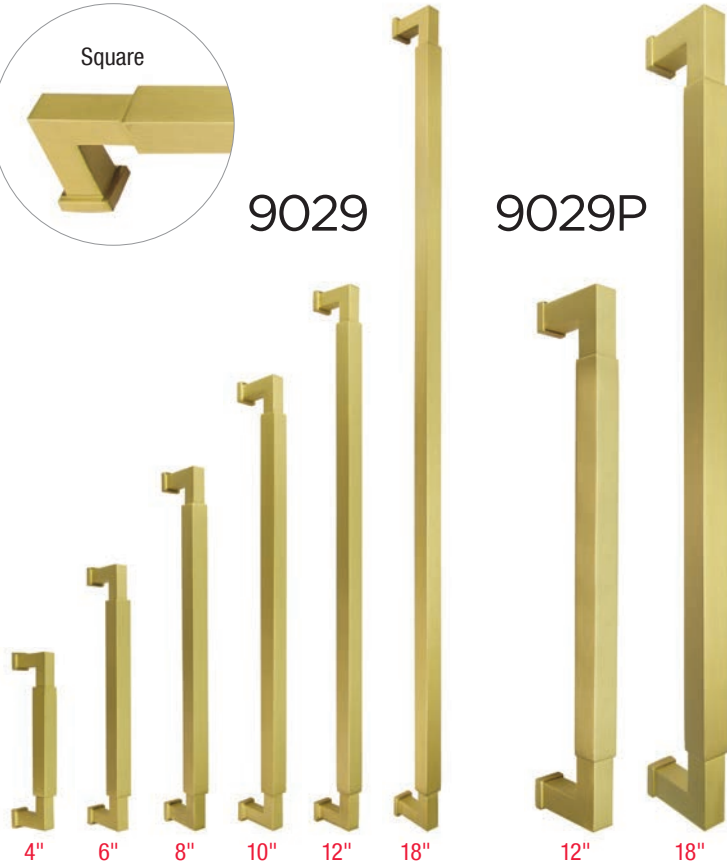
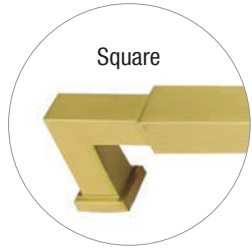

| Item# | Center to Center | Overall Length | Proj. | FINISHES | | | | | |
|------------------------------------------|------------------|----------------|----------|----------|-------|-----|-------|------|------|
| | | | | US3A | US4 | US5 | US10B | US14 | US15 |
| 9029 Cabinet Pull 7/16" W | 9029/102 | 4" | 4 7/16" | 1 3/16" | \$28 | | | | |
| | 9029/153 | 6" | 6 7/16" | | \$38 | | | | |
| | 9029/203 | 8" | 8 7/16" | | \$50 | | | | |
| | 9029/254 | 10" | 10 7/16" | | \$60 | | | | |
| | 9029/305 | 12" | 12 7/16" | | \$72 | | | | |
| | 9029/457 | 18" | 18 7/16" | | \$103 | | | | |
| 9029P Appliance Pull 3/4" W | 9029P/305 | 12" | 12 3/4" | 2 3/16" | \$234 | | | | |
| | 9029P/305B* | 12" | 12 3/4" | | \$234 | | | | |
| | 9029P/457 | 18" | 18 3/4" | | \$345 | | | | |
| | 9029P/457B* | 18" | 18 3/4" | | \$345 | | | | |

*In order to achieve back-to-back, order one regular pull and one B.

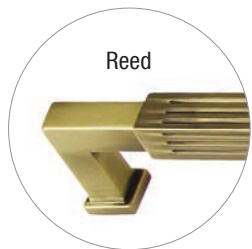

| Item# | Center to Center | Overall Length | Proj. | FINISHES | | | | | |
|------------------------------------------|------------------|----------------|----------|----------|-------|-----|-------|------|------|
| | | | | US3A | US4 | US5 | US10B | US14 | US15 |
| 9031 Cabinet Pull 7/16" W | 9031/102 | 4" | 4 7/16" | 1 3/16" | \$34 | | | | |
| | 9031/153 | 6" | 6 7/16" | | \$46 | | | | |
| | 9031/203 | 8" | 8 7/16" | | \$56 | | | | |
| | 9031/254 | 10" | 10 7/16" | | \$67 | | | | |
| | 9031/305 | 12" | 12 7/16" | | \$78 | | | | |
| | 9031/457 | 18" | 18 7/16" | | \$111 | | | | |
| 9031P Appliance Pull 3/4" W | 9031P/305 | 12" | 12 3/4" | 2 3/16" | \$249 | | | | |
| | 9031P/305B* | 12" | 12 3/4" | | \$249 | | | | |
| | 9031P/457 | 18" | 18 3/4" | | \$370 | | | | |
| | 9031P/457B* | 18" | 18 3/4" | | \$370 | | | | |

*In order to achieve back-to-back, order one regular pull and one B.

Suggested retail prices effective January 3, 2023.

Ultima III

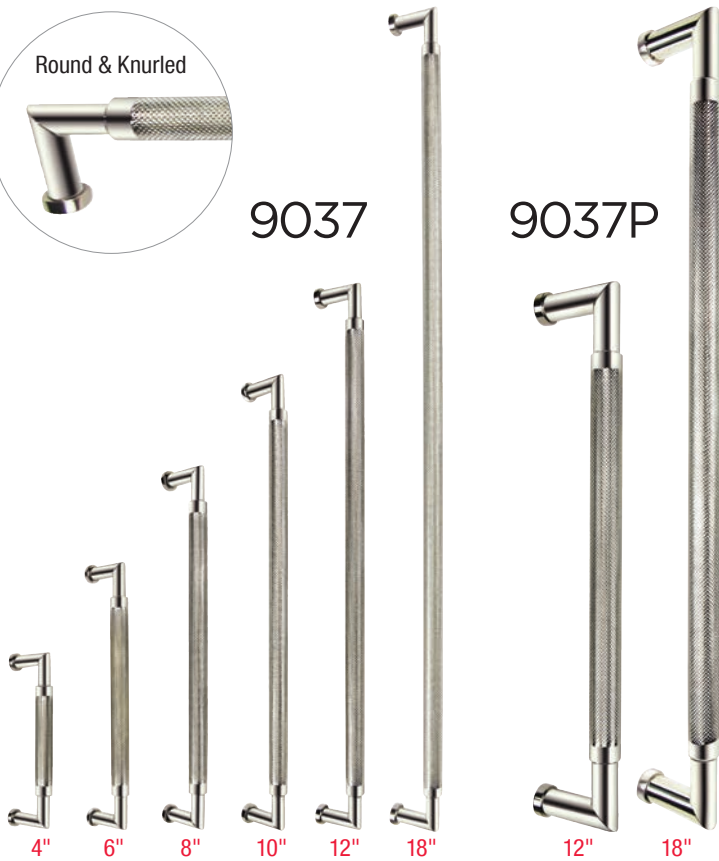

| Item# | Center to Center | Overall Length | Proj. | FINISHES | | | | |
|--------------------------------|--------------------------------------------|-----------------------------------|-----------------------------------|----------------------------------|-----|-----|----------------------|--------------|
| | | | | US3A | US4 | US5 | US10B US14 US15 US26 | |
| 9037 Cabinet Pull | 9037/102 | 4" | 4 ⁷ / ₁₆ " | 1 ¹ / ₈ " | | | | \$28 |
| | 9037/153 | 6" | 6 ⁷ / ₁₆ " | | | | | 38 |
| | 9037/203 | 8" | 8 ⁷ / ₁₆ " | | | | | 50 |
| | 7 ¹ / ₁₆ " max. dia. | 10" | 10 ⁷ / ₁₆ " | | | | | 60 |
| | 9037/305 | 12" | 12 ⁷ / ₁₆ " | | | | | 72 |
| 9037/457 | 18" | 18 ⁷ / ₁₆ " | | | | | 103 | |
| 9037P Appliance Pull | 9037P/305 | 12" | 12 ³ / ₄ " | 2 ¹ / ₈ " | | | | \$234 |
| | 9037P/305B* | 12" | 12 ³ / ₄ " | | | | | 234 |
| | 9037P/457 | 18" | 18 ³ / ₄ " | | | | | 345 |
| | 3 ³ / ₄ " max. dia. | 9037P/457B* | 18" | 18 ³ / ₄ " | | | | 345 |

*In order to achieve back-to-back, order one regular pull and one B.

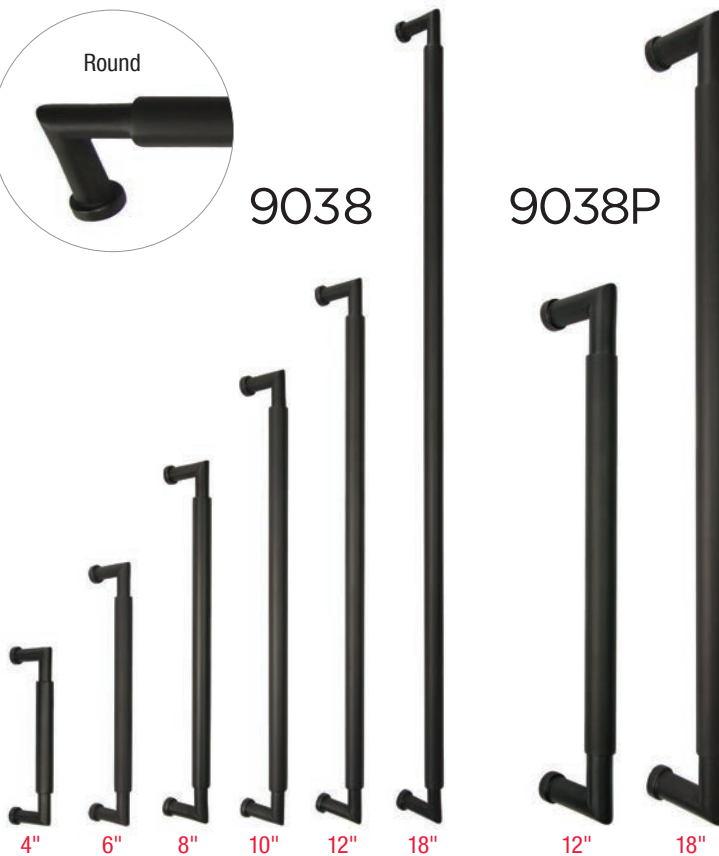

| Item# | Center to Center | Overall Length | Proj. | FINISHES | | | | |
|--------------------------------|--------------------------------------------|-----------------------------------|-----------------------------------|----------------------------------|-----|-----|----------------------|--------------|
| | | | | US3A | US4 | US5 | US10B US14 US15 US26 | |
| 9038 Cabinet Pull | 9038/102 | 4" | 4 ⁷ / ₁₆ " | 1 ¹ / ₈ " | | | | \$28 |
| | 9038/153 | 6" | 6 ⁷ / ₁₆ " | | | | | 38 |
| | 9038/203 | 8" | 8 ⁷ / ₁₆ " | | | | | 50 |
| | 7 ¹ / ₁₆ " max. dia. | 10" | 10 ⁷ / ₁₆ " | | | | | 60 |
| | 9038/305 | 12" | 12 ⁷ / ₁₆ " | | | | | 72 |
| 9038/457 | 18" | 18 ⁷ / ₁₆ " | | | | | 103 | |
| 9038P Appliance Pull | 9038P/305 | 12" | 12 ³ / ₄ " | 2 ¹ / ₈ " | | | | \$234 |
| | 9038P/305B* | 12" | 12 ³ / ₄ " | | | | | 234 |
| | 9038P/457 | 18" | 18 ³ / ₄ " | | | | | 345 |
| | 3 ³ / ₄ " max. dia. | 9038P/457B* | 18" | 18 ³ / ₄ " | | | | 345 |

*In order to achieve back-to-back, order one regular pull and one B.

Suggested retail prices effective January 3, 2023.

Ultima III



9039



9039P



| Item# | Center to Center | Overall Length | Proj. | FINISHES | | | | | | | | |
|-------------------------------------------------------------|------------------|----------------|-----------------------------------|---------------------------------|-----|-----|-------|------|------|------|--|--------------|
| | | | | US3A | US4 | US5 | US10B | US14 | US15 | US26 | | |
| 9039 | 9039/102 | 4" | 4 ⁷ / ₁₆ " | 1 ¹ / ₈ " | | | | | | | | |
| Cabinet Pull 1/2" w | 9039/153 | 6" | 6 ⁷ / ₁₆ " | | | | | | | | | \$28 |
| | 9039/203 | 8" | 8 ⁷ / ₁₆ " | | | | | | | | | 38 |
| | 9039/254 | 10" | 10 ⁷ / ₁₆ " | | | | | | | | | 50 |
| | 9039/305 | 12" | 12 ⁷ / ₁₆ " | | | | | | | | | 60 |
| | 9039/457 | 18" | 18 ⁷ / ₁₆ " | | | | | | | | | 72 |
| | | | | | | | | | | | | 103 |
| 9039P | 9039P/305 | 12" | 12 ³ / ₄ " | 2 ¹ / ₈ " | | | | | | | | \$234 |
| Appliance Pull 1 ³ / ₁₆ " w | 9039P/305B* | 12" | 12 ³ / ₄ " | | | | | | | | | 234 |
| | 9039P/457 | 18" | 18 ³ / ₄ " | | | | | | | | | 345 |
| | 9039P/457B* | 18" | 18 ³ / ₄ " | | | | | | | | | 345 |

*In order to achieve back-to-back, order one regular pull and one B.

Suggested retail prices effective January 3, 2023.

Ultima Knobs

9004

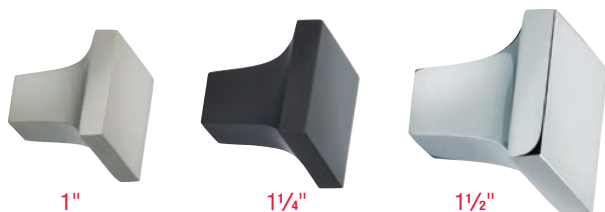

1"

1 1/4"

1 1/2"

| Item# | Width | Proj. | FINISHES | | | |
|---------------------|---------|------------|-----------------------|-------------|---------------------|-------------|
| | | | US3A US10B US15 | US4 US14 | US5 US15 US26 | |
| 9004 Knob | 9004/25 | 1" sq. | 1" | | | \$16 |
| | 9004/32 | 1 1/4" sq. | 1 1/4" | | | 23 |
| | 9004/40 | 1 1/2" sq. | 1 1/2" | | | 34 |

9035



1"

1 1/4"

1 1/2"

| Item# | Dia. | Proj. | FINISHES | | | |
|---------------------|---------|--------|-----------------------|-------------|---------------------|-------------|
| | | | US3A US10B US15 | US4 US14 | US5 US15 US26 | |
| 9035 Knob | 9035/25 | 1" | 1" | | | \$16 |
| | 9035/32 | 1 1/4" | 1 1/4" | | | 23 |
| | 9035/38 | 1 1/2" | 1 1/2" | | | 34 |

9036



1"

1 1/4"

1 1/2"

| Item# | Dia. | Proj. | FINISHES | | | |
|---------------------|---------|--------|-----------------------|-------------|---------------------|-------------|
| | | | US3A US10B US15 | US4 US14 | US5 US15 US26 | |
| 9036 Knob | 9036/25 | 1" | 1 5/16" | | | \$16 |
| | 9036/32 | 1 1/4" | 1 9/16" | | | 23 |
| | 9036/38 | 1 1/2" | 1 1/2" | | | 34 |

9164



1"

1 1/4"

1 1/2"

| Item# | Width of Knob | Width of Rose | Proj. | FINISHES | | | |
|---------------------|---------------|---------------|--------|-----------------------|-------------|---------------------|-------------|
| | | | | US3A US10B US15 | US4 US14 | US5 US15 US26 | |
| 9164 Knob | 9164/25 | 1" | 7/8" | 1" | | | \$16 |
| | 9164/32 | 1 1/4" | 1" | 1 1/4" | | | 23 |
| | 9164/38 | 1 1/2" | 1 1/4" | 1 3/8" | | | 34 |

9165

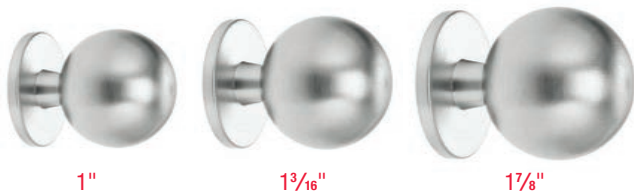

1"

1 3/16"

1 7/8"

Rose is optional upon installation.

| Item# | Dia. of Knob | Dia. of Rose | Proj. | FINISHES | | | |
|---------------------|--------------|--------------|-------|----------------------|--------------|-------------|--------------|
| | | | | US3 US10B US26 | US3A US14 | US4 US15 | US5 US26D |
| 9165 Knob | 9165/25 | 1" | 7/8" | 1 5/8" | | | \$16 |
| | 9165/30 | 1 3/16" | 1" | 1 3/4" | | | 23 |
| | 9165/35 | 1 3/8" | 1" | 1 7/8" | | | 34 |

9151



1"

1 3/16"

1 3/8"

Rose is optional upon installation.

| Item# | Dia. of Knob | Dia. of Rose | Proj. | FINISHES | | | |
|---------------------|--------------|--------------|---------|----------------------|--------------|-------------|-------------|
| | | | | US3 US10B US15 | US3A US14 | US4 US15 | US5 US26 |
| 9151 Knob | 9151/25 | 1" | 7/8" | 1" | | | \$12 |
| | 9151/30 | 1 3/16" | 1 1/16" | 1 1/4" | | | 17 |
| | 9151/35 | 1 3/8" | 1 1/16" | 1 1/2" | | | 24 |

9153

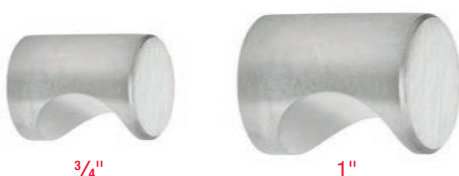

3/4"

1"

| Item# | Dia. | Proj. | FINISHES | | | |
|---------------------|---------|-------|----------------------|--------------|-------------|--------------|
| | | | US3 US10B US26 | US3A US14 | US4 US15 | US5 US26D |
| 9153 Knob | 9153/18 | 3/4" | 1 5/16" | | | \$12 |
| | 9153/25 | 1" | 1 1/4" | | | 17 |

Suggested retail prices effective January 3, 2023.

Ultima II

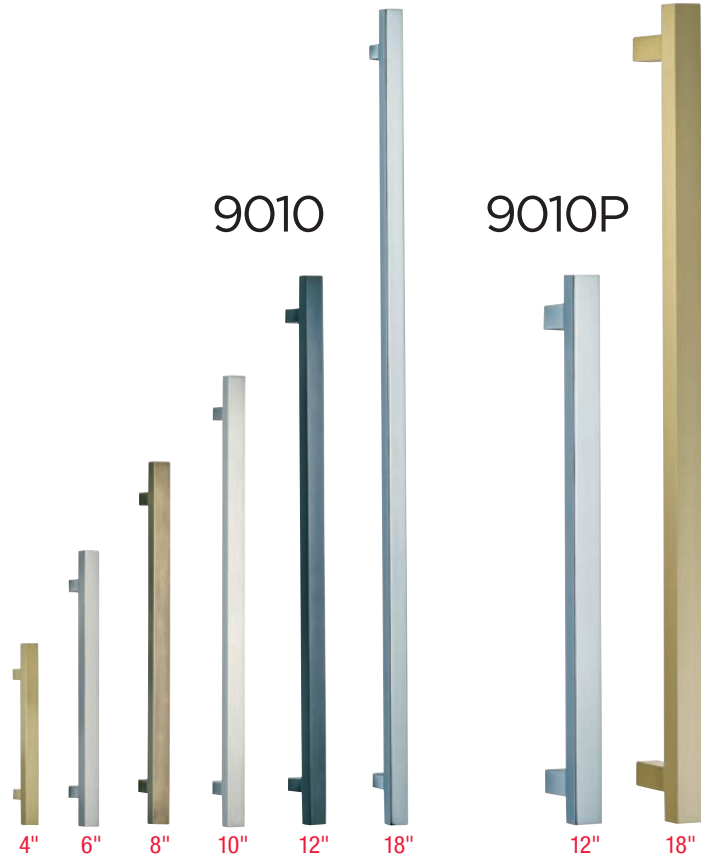

| Item# | Center to Center | Overall Length | Proj. | FINISHES | |
|---------------------------------------------|------------------|----------------|-------|-----------------------------|-------------------------|
| | | | | US4 US14 US15 US26 | US5 US10B |
| 9010 Cabinet Pull 1/2" w | 9010/102 | 4" | 6" | 1 3/8" | \$34 \$40 |
| | 9010/153 | 6" | 8" | | 44 51 |
| | 9010/203 | 8" | 10" | | 54 62 |
| | 9010/254 | 10" | 12" | | 63 73 |
| | 9010/305 | 12" | 14" | | 73 84 |
| 9010/457 | 18" | 20" | | 102 118 | |
| 9010P Appliance Pull 3/4" w | 9010P/305 | 12" | 14" | 2 5/16" | \$177 203 |
| | 9010P/305B* | 12" | 14" | | 177 203 |
| | 9010P/457 | 18" | 20" | | 248 285 |
| | 9010P/457B* | 18" | 20" | | 248 285 |

*In order to achieve back-to-back, order one regular pull and one B.



| Item# | Center to Center | Overall Length | Proj. | FINISHES | |
|---------------------------------------------|------------------|----------------|---------|-----------------------------|---------------------------|
| | | | | US4 US14 US15 US26 | US5 US10B |
| 9023 Cabinet Pull 5/16" w | 9023/102 | 4" | 4 1/2" | 1 3/8" | \$18 \$20 |
| | 9023/153 | 6" | 6 1/2" | | 24 28 |
| | 9023/203 | 8" | 8 1/2" | | 30 34 |
| | 9023/254 | 10" | 10 1/2" | | 38 42 |
| | 9023/305 | 12" | 12 1/2" | | 42 50 |
| 9023/457 | 18" | 18 1/2" | | 62 72 | |
| 9023P Appliance Pull 5/8" w | 9023P/305 | 12" | 12 3/4" | 2 3/16" | \$172 \$197 |
| | 9023P/305B* | 12" | 12 3/4" | | 172 197 |
| | 9023P/457 | 18" | 18 3/4" | | 238 273 |
| | 9023P/457B* | 18" | 18 3/4" | | 238 273 |

*In order to achieve back-to-back, order one regular pull and one B.

Suggested retail prices effective January 3, 2023.

Ultima II

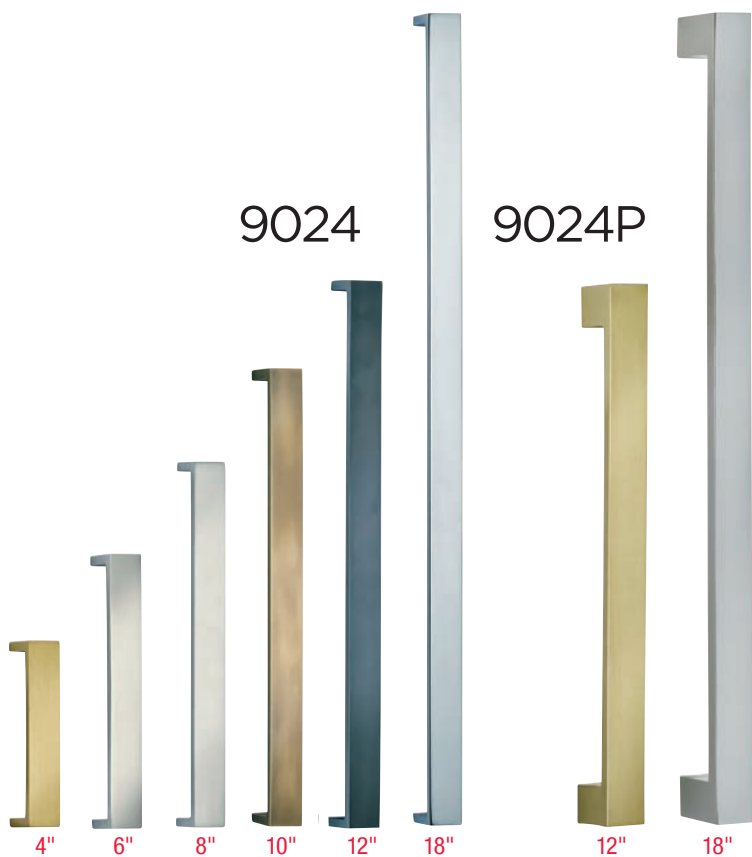

| | Item# | Center to Center | Overall Length | Proj. | FINISHES | |
|-------------------------------------------|-------------|------------------|----------------|-----------|-----------------------------|--------------|
| | | | | | US4 US14 US15 US26 | US5 US10B |
| 9024 Cabinet Pull 3/4" w | 9024/102 | 4" | 4 1/4" | 1 3/16" | \$24 | \$28 |
| | 9024/153 | 6" | 6 1/4" | | 31 | 35 |
| | 9024/203 | 8" | 8 1/4" | | 39 | 44 |
| | 9024/254 | 10" | 10 1/4" | | 46 | 53 |
| | 9024/305 | 12" | 12 1/4" | | 53 | 61 |
| | 9024/457 | 18" | 18 1/4" | 75 | 87 | |
| 9024P Appliance Pull 1" w | 9024P/305 | 12" | 13" | 2" | \$154 | \$177 |
| | 9024P/305B* | 12" | 13" | | 154 | 177 |
| | 9024P/457 | 18" | 19" | | 206 | 237 |
| | 9024P/457B* | 18" | 19" | | 206 | 237 |

*In order to achieve back-to-back, order one regular pull and one B.

Bases are larger than cabinet pull bases to accommodate appliance mounting screws.

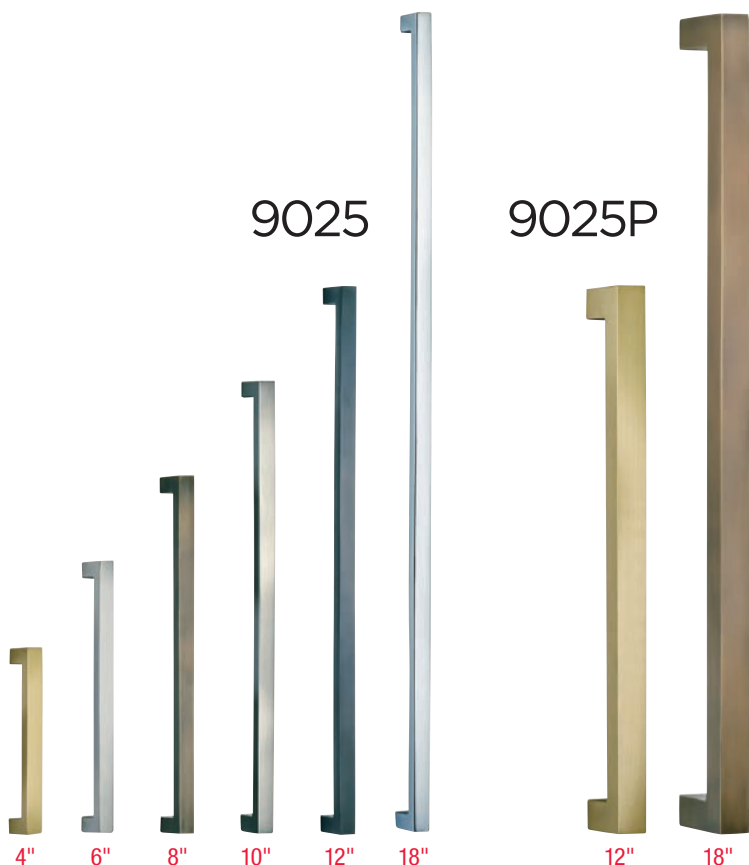

| | Item# | Center to Center | Overall Length | Proj. | FINISHES | |
|---------------------------------------------|-------------|------------------|----------------|-----------|-----------------------------|--------------|
| | | | | | US4 US14 US15 US26 | US5 US10B |
| 9025 Cabinet Pull 3/8" w | 9025/102 | 4" | 4 7/16" | 1 3/16" | \$20 | \$23 |
| | 9025/153 | 6" | 6 7/16" | | 28 | 31 |
| | 9025/203 | 8" | 8 7/16" | | 33 | 38 |
| | 9025/254 | 10" | 10 7/16" | | 40 | 46 |
| | 9025/305 | 12" | 12 7/16" | | 47 | 54 |
| | 9025/457 | 18" | 18 7/16" | 66 | 75 | |
| 9025P Appliance Pull 3/4" w | 9025P/305 | 12" | 12 3/4" | 2" | \$176 | \$202 |
| | 9025P/305B* | 12" | 12 3/4" | | 176 | 202 |
| | 9025P/457 | 18" | 18 3/4" | | 246 | 283 |
| | 9025P/457B* | 18" | 18 3/4" | | 246 | 283 |

*In order to achieve back-to-back, order one regular pull and one B.

Suggested retail prices effective January 3, 2023.

Ultima II



9027

9027P

| Item# | Center to Center | Overall Length | Proj. | FINISHES | | |
|-------------------------------------------------|------------------|----------------|----------|-----------------------------|--------------|--------------|
| | | | | US4 US14 US15 US26 | US5 US10B | |
| 9027 Cabinet Pull 3/8" w | 9027/102 | 4" | 4 7/16" | 1 3/16" | \$15 | \$17 |
| | 9027/153 | 6" | 6 7/16" | | 19 | 23 |
| | 9027/203 | 8" | 8 7/16" | | 24 | 28 |
| | 9027/254 | 10" | 10 7/16" | | 30 | 34 |
| | 9027/305 | 12" | 12 7/16" | | 34 | 40 |
| 9027/457 | 18" | 18 7/16" | | 49 | 55 | |
| 9027P Appliance Pull 3/4" w | 9027P/305 | 12" | 12 3/4" | 2" | \$139 | \$160 |
| | 9027P/305B* | 12" | 12 3/4" | | 139 | 160 |
| | 9027P/457 | 18" | 18 3/4" | | 194 | 224 |
| | 9027P/457B* | 18" | 18 3/4" | | 194 | 224 |

*In order to achieve back-to-back, order one regular pull and one B.



9028

9028P



| Item# | Center to Center | Overall Length | Proj. | FINISHES | | |
|-----------------------------------------------|------------------|----------------|---------|-----------------------------|--------------|--------------|
| | | | | US4 US14 US15 US26 | US5 US10B | |
| 9028 Cabinet Pull 7/16" w | 9028/102 | 4" | 4 1/2" | 1 3/16" | \$17 | \$19 |
| | 9028/153 | 6" | 6 1/2" | | 20 | 24 |
| | 9028/203 | 8" | 8 1/2" | | 26 | 29 |
| | 9028/254 | 10" | 10 1/2" | | 30 | 33 |
| | 9028/305 | 12" | 12 1/2" | | 33 | 39 |
| 9028/457 | 18" | 18 1/2" | | 49 | 55 | |
| 9028P Appliance Pull 1" w | 9028P/305 | 12" | 13" | 2" | \$146 | \$168 |
| | 9028P/305B* | 12" | 13" | | 146 | 168 |
| | 9028P/457 | 18" | 19" | | 194 | 224 |
| | 9028P/457B* | 18" | 19" | | 194 | 224 |

*In order to achieve back-to-back, order one regular pull and one B.

Suggested retail prices effective January 3, 2023.

Ultima I



| Item# | Center to Center | Overall Length | Proj. | FINISHES | | |
|------------------------------------------|------------------|----------------|-------|-----------------------|-------------|-------------|
| | | | | US10B US15 US26 | NON-STOCK* | |
| 9005 Cabinet Pull 5/8" W | 9005/96 | 3 3/4" | 4" | 1 1/8" | \$16 | \$25 |
| | 9005/146 | 5 3/4" | 6" | | 21 | 30 |
| | 9005/197 | 7 3/4" | 8" | | 30 | 40 |

Use 9006P below as a coordinating Appliance Pull.

*Non-stock finishes require a 12-week lead time and a minimum order of \$500.00 list.



| Item# | Center to Center | Overall Length | Proj. | FINISHES | | |
|--------------------------------------------|------------------|----------------|-----------|-----------------------|--------------|--------------|
| | | | | US10B US15 US26 | NON-STOCK* | |
| 9006 Cabinet Pull 15/16" W | 9006/96 | 3 3/4" | 4" | 1 1/8" | \$24 | \$30 |
| | 9006/146 | 5 3/4" | 6" | | 33 | 42 |
| | 9006/197 | 7 3/4" | 8" | | 44 | 55 |
| 9006P Appliance Pull 1" W | 9006P/440 | 17 5/16" | 17 15/16" | 2" | \$227 | \$284 |
| | 9006P/440B** | 17 5/16" | 17 15/16" | | 227 | 284 |

*Non-stock finishes require a 12-week lead time and a minimum order of \$500.00 list.

**In order to achieve back-to-back, order one regular pull and one B.

Suggested retail prices effective January 3, 2023.

Ultima I

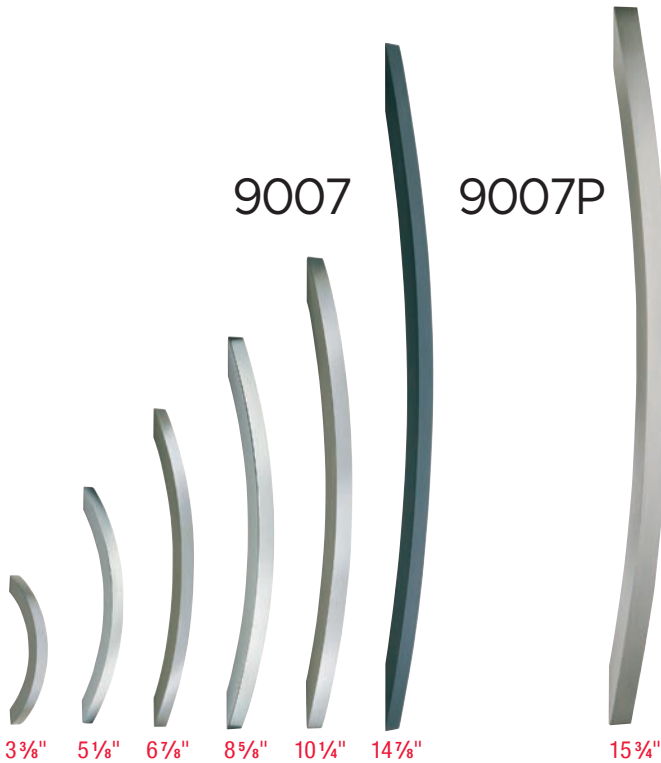

| | Item# | Center to Center | Overall Length | Proj. | FINISHES | | | NON-STOCK* | | |
|------------------------------------------|-------------|------------------|----------------|---------|--------------|------|------|--------------|------|-----|
| | | | | | US10B | US15 | US26 | US3 | US3A | US4 |
| 9007 Cabinet Pull 3/8" W | 9007/86 | 3 3/8" | 4" | 1 3/16" | \$15 | | | \$20 | | |
| | 9007/130 | 5 1/8" | 6" | | 19 | | | 29 | | |
| | 9007/175 | 6 7/8" | 8" | | 24 | | | 33 | | |
| 1/2" W | 9007/220 | 8 5/8" | 10" | 1 5/16" | \$50 | | | \$65 | | |
| | 9007/260 | 10 1/4" | 12" | | 58 | | | 77 | | |
| | 9007/377 | 14 7/8" | 18" | 1 3/8" | 87 | | | 109 | | |
| 9007P Appliance Pull 5/8" W | 9007P/400** | 15 3/4" | 17 15/16" | 2" | \$170 | | | \$213 | | |

*Non-stock finishes require a 12-week lead time and a minimum order of \$500.00 list.

**Not available back-to-back.

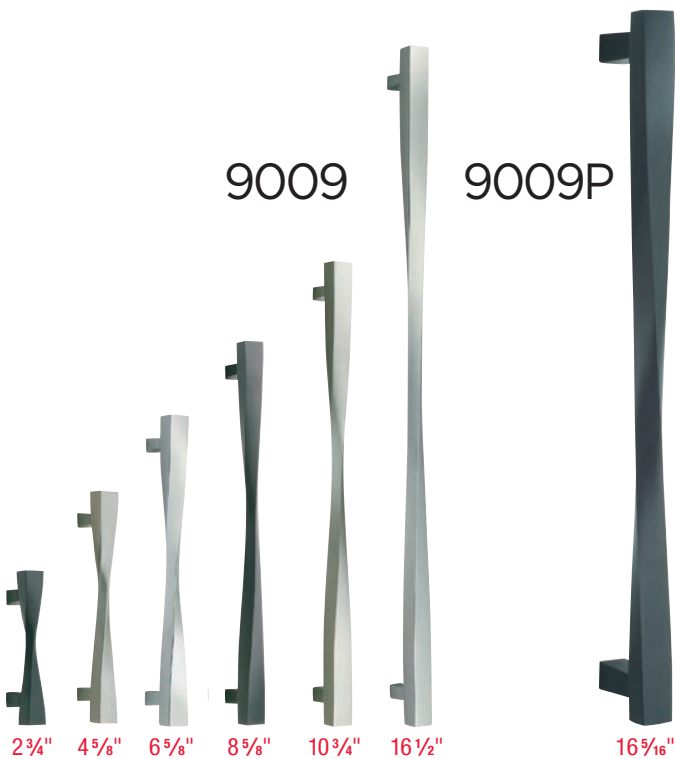

| | Item# | Center to Center | Overall Length | Proj. | FINISHES | | | NON-STOCK* | | |
|----------------------------------------------------------|--------------|------------------|----------------|--------|--------------|------|------|--------------|------|-----|
| | | | | | US10B | US15 | US26 | US3 | US3A | US4 |
| 9009 Cabinet Pull 9/16" W | 9009/70 | 2 3/4" | 4" | 1 3/8" | \$21 | | | \$28 | | |
| | 9009/118 | 4 5/8" | 6" | | 31 | | | 41 | | |
| | 9009/170 | 6 5/8" | 8" | | 42 | | | 55 | | |
| | 9009/220 | 8 5/8" | 10" | | 49 | | | 63 | | |
| | 9009/273 | 10 3/4" | 12 1/4" | 1 1/2" | 69 | | | 87 | | |
| | 9009/420 | 16 1/2" | 18" | | 101 | | | 127 | | |
| 9009P Appliance Pull 7/8" W at widest point | 9009P/415 | 16 5/16" | 18" | 2 5/8" | \$297 | | | \$372 | | |
| | 9009P/415B** | 16 5/16" | 18" | | 297 | | | 372 | | |

*Non-stock finishes require a 12-week lead time and a minimum order of \$500.00 list.

**In order to achieve back-to-back, order one regular pull and one B.

Suggested retail prices effective January 3, 2023.

Ultima I



| | Item# | Center to Center | Overall Length | Proj. | FINISHES | | | NON-STOCK* | | |
|----------------------------------------------------------|--------------|------------------|----------------|--------|--------------|------|------|------------|------|--------------|
| | | | | | US10B | US15 | US26 | US3 | US3A | US4 |
| 9013 Cabinet Pull 3/8" W | 9013/150 | 6" | 8" | 1 1/8" | \$35 | | | | | \$46 |
| | 9013/238 | 9 3/8" | 11" | | 42 | | | | | 55 |
| | 9013/311 | 12 1/4" | 14" | | 49 | | | | | 64 |
| 9013P Appliance Pull 3/4" W at widest point | 9013P/415 | 16 5/16" | 17 15/16" | 1 7/8" | \$183 | | | | | \$229 |
| | 9013P/415B** | 16 5/16" | 17 15/16" | | 183 | | | | | 229 |

*Non-stock finishes require a 12-week lead time and a minimum order of \$500.00 list.

**In order to achieve back-to-back, order one regular pull and one B.

Suggested retail prices effective January 3, 2023.

TRADITIONS



9030



3 1/2"



5"



7"



12"



18"

| Item# | Center to Center | Overall Length | Max. Dia. | FINISHES | |
|----------------------------------|------------------|----------------|-----------|-----------------------------|--------------------------|
| | | | | US3 US14 US15 US26 | US5 US10B |
| 9030 Cabinet Pull | 9030/89 | 3 1/2" | 4" | 15/32" | \$16 \$19 |
| | 9030/128 | 5" | 5 1/2" | 17/32" | 21 26 |
| | 9030/178 | 7" | 7 5/8" | 5/8" | 38 45 |
| 9030 Appliance Pull | 9030/305 | 12" | 12 3/4" | 7/8" | \$92 \$108 |
| | 9030/458 | 18" | 18 7/8" | 1" | 197 227 |

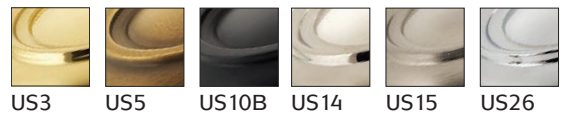

9040



3 1/2"



5"



7"



12"



18"

| Item# | Center to Center | Overall Length | Max. Dia. | FINISHES | |
|----------------------------------|------------------|----------------|-----------|-----------------------------|--------------------------|
| | | | | US3 US14 US15 US26 | US5 US10B |
| 9040 Cabinet Pull | 9040/89 | 3 1/2" | 4" | 9/16" | \$16 \$19 |
| | 9040/128 | 5" | 5 5/8" | 5/8" | 21 26 |
| | 9040/178 | 7" | 7 5/8" | 11/16" | 38 45 |
| 9040 Appliance Pull | 9040/305 | 12" | 12 7/8" | 13/16" | \$92 \$108 |
| | 9040/458 | 18" | 19" | 15/16" | 197 227 |

Suggested retail prices effective January 3, 2023.

TRADITIONS

9045



1"



1 1/4"



1 1/2"



| Item# | Dia. | Proj. | FINISHES | | |
|------------------|---------|--------|----------|-------------|-------|
| | | | US3 | US5 | US10B |
| 9045 Knob | 9045/25 | 1" | 1 1/16" | \$14 | |
| | 9045/31 | 1 1/4" | 1 5/16" | 21 | |
| | 9045/38 | 1 1/2" | 1 1/2" | 35 | |

Prodigy

9566

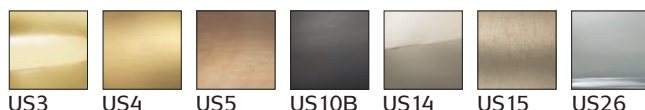

| Item# | Dia. | Proj. | FINISHES | | |
|------------------|---------|---------|----------|-------------|-----|
| | | | US3 | US4 | US5 |
| 9566 Knob | 9566/32 | 1 5/16" | 1 1/16" | \$29 | |

9936



| Item# | Dia. | Proj. | FINISHES | | |
|------------------|---------|--------|----------|-------------|-----|
| | | | US3 | US4 | US5 |
| 9936 Knob | 9936/32 | 1 1/4" | 1 1/16" | \$29 | |

9955

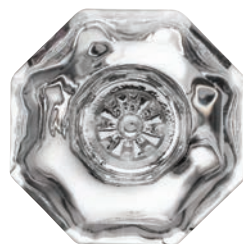

| Item# | Dia. | Proj. | FINISHES | | |
|------------------|---------|--------|----------|-------------|-----|
| | | | US3 | US4 | US5 |
| 9955 Knob | 9955/32 | 1 1/4" | 1 1/16" | \$29 | |

9956



| Item# | Dia. | Proj. | FINISHES | | |
|------------------|---------|---------|----------|-------------|-----|
| | | | US3 | US4 | US5 |
| 9956 Knob | 9956/32 | 1 1/16" | 1 1/16" | \$29 | |

Suggested retail prices effective January 3, 2023.

STAINLESS STEEL

9457

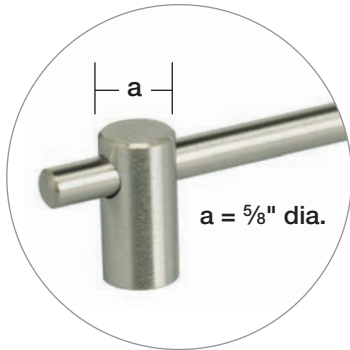

| | Item# | Center to Center | Overall Length | Proj. | FINISH US32D |
|----------------|----------|------------------|----------------|-------|-----------------|
| 9457 | 9457/96 | 3 3/4" | 5 3/8" | 1" | \$31 |
| Cabinet | 9457/128 | 5" | 6 5/8" | | 31 |
| Pull | 9457/160 | 6 3/8" | 7 7/8" | | 32 |
| 8 mm diameter | 9457/192 | 7 5/8" | 9 1/8" | | 34 |

9458

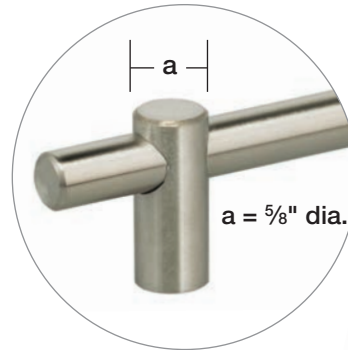

| | Item# | Center to Center | Overall Length | Proj. | FINISH US32D |
|----------------|----------|------------------|----------------|--------|-----------------|
| 9458 | 9458/128 | 5" | 7 1/4" | 1 1/4" | \$33 |
| Cabinet | 9458/192 | 7 5/8" | 9 3/4" | | 41 |
| Pull | 9458/320 | 12 5/8" | 14 15/16" | | 54 |
| 12 mm diameter | 9458/448 | 17 5/8" | 20 1/8" | | 70 |

Suggested retail prices effective January 3, 2023.

STAINLESS STEEL

9464



| | Item# | Center to Center | Overall Length | Proj. | FINISH US32D |
|---------------------------------------------------------|----------|-----------------------------------|-----------------------------------|----------------------------------|-----------------|
| 9464 Cabinet Pull 10 mm diameter | 9464/76 | 3" | 4 ¹⁵ / ₁₆ " | 1 ³ / ₁₆ " | \$14 |
| | 9464/96 | 3 ³ / ₄ " | 5 ³ / ₄ " | | 15 |
| | 9464/128 | 5" | 7" | | 18 |
| | 9464/192 | 7 ⁵ / ₈ " | 9 ¹ / ₂ " | | 23 |
| | 9464/320 | 12 ⁵ / ₈ " | 14 ⁹ / ₁₆ " | | 33 |
| | 9464/448 | 17 ⁵ / ₈ " | 20 ¹ / ₂ " | | 47 |
| | 9464/640 | 25 ³ / ₁₆ " | 28 ³ / ₈ " | | 85 |

9465



| | Item# | Center to Center | Overall Length | Proj. | FINISH US32D |
|---------------------------------------------------------|----------|-----------------------------------|-----------------------------------|---------------------------------|-----------------|
| 9465 Cabinet Pull 14 mm diameter | 9465/96 | 3 ³ / ₄ " | 5 ³ / ₄ " | 1 ³ / ₈ " | \$32 |
| | 9465/128 | 5" | 7" | | 37 |
| | 9465/192 | 7 ⁵ / ₈ " | 9 ¹ / ₂ " | | 46 |
| | 9465/320 | 12 ⁵ / ₈ " | 14 ⁹ / ₁₆ " | | 58 |
| | 9465/448 | 17 ⁵ / ₈ " | 20 ¹ / ₂ " | | 70 |
| | 9465/640 | 25 ³ / ₁₆ " | 28 ³ / ₈ " | | 83 |
| | 9465/736 | 29" | 32 ¹ / ₄ " | | 98 |

Suggested retail prices effective January 3, 2023.

STAINLESS STEEL

9450

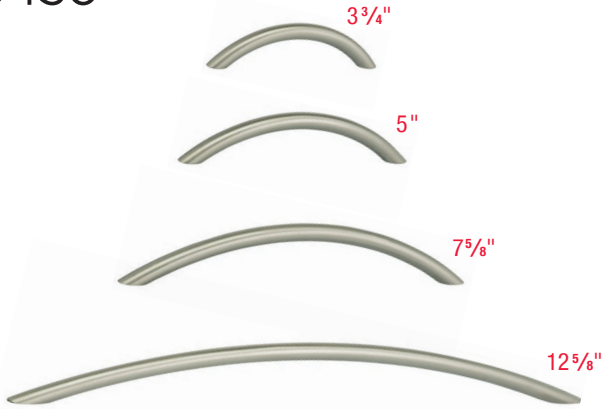

| | Item# | Center to Center | Overall Length | Proj. | FINISH US32D |
|-----------------------------------------------|----------|----------------------------------|-----------------------------------|----------------------------------|--------------|
| 9450 Cabinet Pull 10 mm diameter | 9450/96 | 3 ³ / ₄ " | 4 ⁵ / ₈ " | 1 ¹ / ₈ " | \$14 |
| | 9450/128 | 5" | 5 ⁷ / ₈ " | 1 ³ / ₁₆ " | 15 |
| | 9450/192 | 7 ⁵ / ₈ " | 8 ³ / ₄ " | 1 ³ / ₈ " | 21 |
| | 9450/320 | 12 ⁵ / ₈ " | 14 ⁹ / ₁₆ " | | 43 |

9533



| | Item# | Center to Center | Overall Length | Proj. | FINISH US32D |
|-----------------------------------------------|----------|----------------------------------|----------------------------------|----------------------------------|--------------|
| 9533 Cabinet Pull 10 mm diameter | 9533/64 | 2 ⁹ / ₁₆ " | 3 ⁵ / ₈ " | 1 ¹ / ₈ " | \$13 |
| | 9533/96 | 3 ³ / ₄ " | 5 ³ / ₁₆ " | 1 ³ / ₁₆ " | 14 |
| | 9533/128 | 5" | 6 ³ / ₄ " | 1 ¹ / ₄ " | 15 |

9537



| | Item# | Center to Center | Overall Length | Proj. | FINISH US32D |
|----------------------------------------------|----------|------------------|---------------------------------|----------------------------------|--------------|
| 9537 Cabinet Pull 8 mm diameter | 9537/76 | 3" | 3 ³ / ₈ " | 1 ³ / ₁₆ " | \$12 |
| | 9537/102 | 4" | 4 ³ / ₈ " | | 13 |
| | 9537/128 | 5" | 5 ³ / ₈ " | | 14 |

9538



| | Item# | Center to Center | Overall Length | Proj. | FINISH US32D |
|-----------------------------------------------|----------|------------------|----------------------------------|---------------------------------|--------------|
| 9538 Cabinet Pull 10 mm diameter | 9538/76 | 3" | 3 ⁷ / ₁₆ " | 1 ³ / ₈ " | \$13 |
| | 9538/102 | 4" | 4 ⁷ / ₁₆ " | | 14 |
| | 9538/128 | 5" | 5 ¹ / ₂ " | | 15 |

Suggested retail prices effective January 3, 2023.

STAINLESS STEEL

9100



| | Item# | Dia. | Proj. | FINISH US32D |
|---------------------|---------|----------------------------------|---------------------------------|-----------------|
| 9100 Knob | 9100/25 | 1" | 7/8" | \$11 |
| | 9100/30 | 1 ³ / ₁₆ " | 1 ¹ / ₈ " | 15 |

9153



| | Item# | Dia. | Proj. | FINISH US32D |
|---------------------|---------|----------------------------------|---------------------------------|-----------------|
| 9153 Knob | 9153/18 | 3/4" | 1" | \$11 |
| | 9153/21 | 1 ³ / ₁₆ " | 1 ¹ / ₈ " | 15 |

9180



| | Item# | Dia. | Proj. | FINISH US32D |
|---------------------|---------|----------------------------------|---------------------------------|-----------------|
| 9180 Knob | 9180/25 | 1" | 1 ¹ / ₈ " | \$15 |
| | 9180/30 | 1 ³ / ₁₆ " | 1 ¹ / ₄ " | 23 |

9181



| | Item# | Dia. | Proj. | FINISH US32D |
|---------------------|---------|----------------------------------|----------------------------------|-----------------|
| 9181 Knob | 9181/20 | 3/4" | 1" | \$11 |
| | 9181/24 | 1 ⁵ / ₁₆ " | 1 ³ / ₁₆ " | 15 |

Suggested retail prices effective January 3, 2023.

Legacy

9100
Knob



| Item# | Dia. | Proj. | FINISHES | | | |
|---------|---------|--------|-------------|----------------|------------|---------------|
| | | | US3 US26 | US10B US26D | US14 VB | US15 VC VI |
| 9100/31 | 1 7/32" | 1 1/8" | \$16 | | | |

9102
Knob



| Item# | Dia. | Proj. | FINISHES | | | |
|---------|---------|--------|-------------|-------------|------------|------------|
| | | | US3 US26 | US10B VB | US14 VC | US15 VI |
| 9102/30 | 1 3/16" | 1 1/8" | \$18 | | | |

9105
Knob



| Item# | Dia. | Proj. | FINISHES | | | |
|---------|--------|--------|-------------|----------------|------------|---------------|
| | | | US3 US26 | US10B US26D | US14 VB | US15 VC VI |
| 9105/35 | 1 3/8" | 1 1/2" | \$16 | | | |

9130
Knob



| Item# | Dia. | Proj. | FINISHES | | | |
|---------|---------|---------|-------------|------|------|----|
| | | | US3 | US14 | US15 | SB |
| 9130/30 | 1 3/16" | 1 1/16" | \$14 | | | |

9141
Knob



| Item# | Dia. | Proj. | FINISHES | | | |
|---------|---------|-------|-------------|-------------|------------|---------------|
| | | | US3 US26 | US10B SB | US14 VB | US15 VC VI |
| 9141/30 | 1 3/16" | 1" | \$18 | | | |

9158
Knob



| Item# | Dia. | Proj. | FINISHES | | | |
|---------|---------|---------|-------------|---------------|------|--|
| | | | US3 US15 | US10B US26 | US14 | |
| 9158/30 | 1 3/16" | 1 5/32" | \$18 | | | |

9430
Knob



| Item# | Dia. | Proj. | FINISHES | | | |
|---------|--------|--------|-------------|-------------|------------|---------------|
| | | | US3 US26 | US10B SB | US14 VB | US15 VC VI |
| 9430/32 | 1 1/4" | 1 1/4" | \$18 | | | |

Suggested retail prices effective January 3, 2023.

Suggested retail prices effective January 3, 2023.

Ornate

7105



| | Item# | Dia. | Proj. | FINISHES | | |
|---------------------|---------|---------|---------|----------|-------|-------------|
| | | | | US3 | US15A | SB |
| 7105 Knob | 7105/30 | 1 3/16" | 1" | | | \$41 |
| | 7105/40 | 1 9/16" | 1 3/16" | | | 58 |

7417



| | Item# | Dia. | Proj. | FINISHES | | |
|---------------------|---------|--------|---------|----------|-------|-------------|
| | | | | US3 | US15A | SB |
| 7417 Knob | 7417/28 | 1 1/8" | 1" | | | \$44 |
| | 7417/33 | 1 3/8" | 1 1/8" | | | 42 |
| | 7417/42 | 1 5/8" | 1 3/16" | | | 60 |

7420



| | Item# | Dia. | Proj. | FINISHES | | |
|---------------------|---------|----------|---------|----------|-------|-------------|
| | | | | US3 | US15A | SB |
| 7420 Knob | 7420/28 | 1 1/8" | 1 3/16" | | | \$39 |
| | 7420/33 | 1 5/16" | 1" | | | 42 |
| | 7420/46 | 1 13/16" | 1 3/16" | | | 58 |

7430



| | Item# | Dia. | Proj. | FINISHES | | |
|---------------------|---------|---------|--------|----------|-------|-------------|
| | | | | US3 | US15A | SB |
| 7430 Knob | 7430/30 | 1 3/16" | 1 1/8" | | | \$41 |
| | 7430/38 | 1 1/2" | 1 1/8" | | | 56 |
| | 7430/47 | 1 7/8" | 1 1/8" | | | 70 |

7432



| | Item# | Dia. | Proj. | FINISHES | | |
|---------------------|---------|--------|---------|----------|------|-------------|
| | | | | US3 | US14 | US15A SB |
| 7432 Pull | 7432/76 | 3" | 1 3/8" | | | \$53 |
| | 7432/89 | 3 1/2" | 1 9/16" | | | 61 |

7434



| | Item# | Dia. | Proj. | FINISHES | | |
|---------------------|---------|--------|---------|----------|-------|-------------|
| | | | | US3 | US15A | SB |
| 7434 Knob | 7434/28 | 1 1/8" | 1" | | | \$38 |
| | 7434/35 | 1 3/8" | 1 3/16" | | | 50 |
| | 7434/42 | 1 5/8" | 1 1/4" | | | 60 |

7435



| | Item# | Dia. | Proj. | FINISHES | | |
|---------------------|---------|---------|---------|----------|-------|-------------|
| | | | | US3 | US15A | SB |
| 7435 Knob | 7435/25 | 1" | 1 3/16" | | | \$31 |
| | 7435/30 | 1 3/16" | 1" | | | 40 |
| | 7435/40 | 1 9/16" | 1 3/16" | | | 50 |

7436



| | Item# | Dia. | Proj. | FINISHES | | |
|---------------------|---------|---------|---------|----------|------|-------------|
| | | | | US3 | US14 | US15A SB |
| 7436 Knob | 7436/25 | 1" | 1 3/16" | | | \$31 |
| | 7436/30 | 1 3/16" | 1" | | | 40 |
| | 7436/40 | 1 9/16" | 1 3/16" | | | 55 |

STAINLESS STEEL

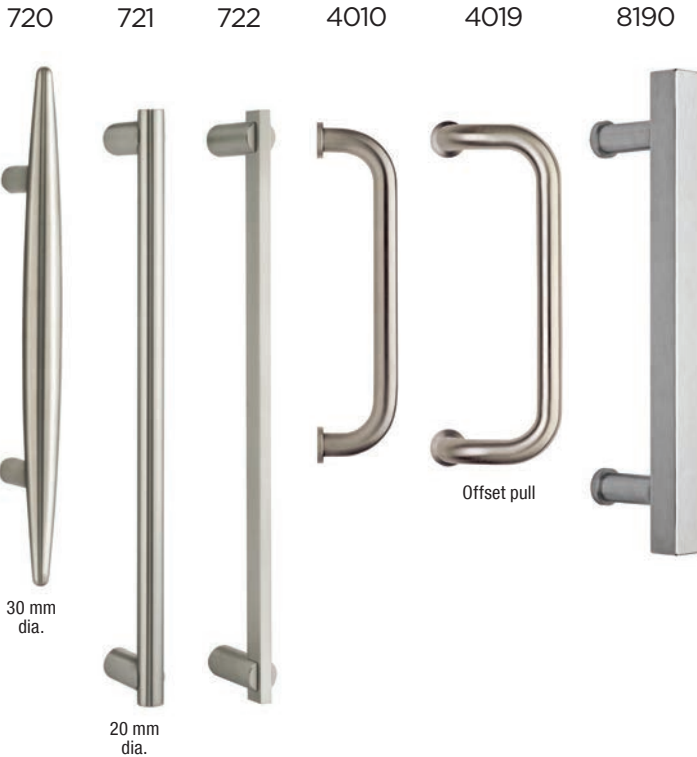

| | Item# | Center to Center | Overall Length | Proj. | FINISH US32D |
|-------------|-----------|------------------------------------|-----------------------------------|-----------------------------------|-----------------|
| 720 | 720/220 | 8 ⁵ / ₈ " | 15" | 2 ³ / ₄ " | \$227 |
| 721 | 721/400 | 15 ³ / ₄ " | 17 ⁵ / ₁₆ " | 2 ⁹ / ₁₆ " | \$189 |
| | 721/800 | 31 ¹ / ₂ " | 33" | 2 ⁹ / ₁₆ " | 317 |
| 722 | 722/400 | 15 ³ / ₄ " | 17 ⁵ / ₁₆ " | 2 ⁹ / ₁₆ " | \$153 |
| 4010 | 4010/300 | 8" | 9" | 2 ⁵ / ₈ " | \$168 |
| | 4010/B300 | 8" | 9" | 2 ⁵ / ₈ " | 356 |
| | 4010/400 | 12" | 13 ¹ / ₄ " | 2 ¹⁵ / ₁₆ " | 222 |
| | 4010/B400 | 12" | 13 ¹ / ₄ " | 2 ¹⁵ / ₁₆ " | 462 |
| | 4010/500 | 16" | 17 ¹ / ₂ " | 3 ³ / ₈ " | 288 |
| 4010/B500 | 16" | 17 ¹ / ₂ " | 3 ³ / ₈ " | 593 | |
| 4019 | 4019/300 | 8" | 9" | 2 ⁵ / ₈ " | \$229 |
| | 4019/B300 | 8" | 9" | 2 ⁵ / ₈ " | 478 |
| | 4019/400 | 12" | 13 ¹ / ₄ " | 2 ¹⁵ / ₁₆ " | 283 |
| | 4019/B400 | 12" | 13 ¹ / ₄ " | 2 ¹⁵ / ₁₆ " | 585 |
| | 4019/500 | 16" | 17 ¹ / ₂ " | 3 ³ / ₈ " | 347 |
| 4019/B500 | 16" | 17 ¹ / ₂ " | 3 ³ / ₈ " | 713 | |
| 8190 | 8190/300 | 11 ¹³ / ₁₆ " | 15 ³ / ₄ " | 3 ⁹ / ₁₆ " | \$344 |
| | 8190/B300 | 11 ¹³ / ₁₆ " | 15 ³ / ₄ " | 3 ⁹ / ₁₆ " | 719 |
| | 8190/400 | 15 ³ / ₄ " | 23 ⁵ / ₈ " | 3 ⁹ / ₁₆ " | 365 |
| | 8190/B400 | 15 ³ / ₄ " | 23 ⁵ / ₈ " | 3 ⁹ / ₁₆ " | 756 |

For full Stainless Steel line, please see pages 19–23.
All pulls are available back-to-back.

ELITE



| Item# | Center to Center | Overall Length | Proj. | FINISHES | |
|--------------------------|------------------|----------------|------------------------------------|----------------------------------|----------------------|
| | | | | US4 US14 US26 | US5 US10B US15 |
| 1968P 19/32" W | 1968P/305 | 12" | 12 ¹⁵ / ₁₆ " | 1 ³ / ₁₆ " | \$203 \$215 |
| | 1968P/305BB* | 12" | 12 ¹⁵ / ₁₆ " | 1 ³ / ₁₆ " | 203 215 |
| | 1968P/457 | 18" | 18 ¹⁵ / ₁₆ " | 1 ³ / ₁₆ " | 261 272 |
| | 1968P/457BB* | 18" | 18 ¹⁵ / ₁₆ " | 1 ³ / ₁₆ " | 261 272 |
| 1969P 19/32" W | 1969P/305 | 12" | 13 ¹ / ₈ " | 1 ³ / ₄ " | \$220 \$229 |
| | 1969P/305BB* | 12" | 13 ¹ / ₈ " | 1 ³ / ₄ " | 220 229 |
| | 1969P/457 | 18" | 19 ¹ / ₈ " | 1 ³ / ₄ " | 272 278 |
| | 1969P/457BB* | 18" | 19 ¹ / ₈ " | 1 ³ / ₄ " | 272 278 |
| 1970P 13/16" W | 1970P/305 | 12" | 14 ³ / ₄ " | 1 ³ / ₄ " | \$220 \$229 |
| | 1970P/305BB* | 12" | 14 ³ / ₄ " | 1 ³ / ₄ " | 220 229 |
| | 1970P/457 | 18" | 20 ³ / ₄ " | 1 ³ / ₄ " | 272 278 |
| | 1970P/457BB* | 18" | 20 ³ / ₄ " | 1 ³ / ₄ " | 272 278 |
| 1971P 13/16" W | 1971P/305 | 12" | 12 ¹¹ / ₁₆ " | 1 ³ / ₄ " | \$203 \$215 |
| | 1971P/305BB* | 12" | 12 ¹¹ / ₁₆ " | 1 ³ / ₄ " | 203 215 |
| | 1971P/457 | 18" | 18 ⁹ / ₁₆ " | 1 ³ / ₄ " | 261 272 |
| | 1971P/457BB* | 18" | 18 ⁹ / ₁₆ " | 1 ³ / ₄ " | 261 272 |

*In order to achieve back-to-back, order one regular pull and one BB.

For full Elite line, please see pages 4–5.

Suggested retail prices effective January 3, 2023.

TRADITIONS

9030

9040



| Item# | Center to Center | Overall Length | Proj. | FINISHES | | |
|-------------|------------------|----------------|----------------------------------|-----------------------------------|--------------|--------------|
| | | | | US3 US14 US15 US26 | US5 US10B | |
| 9030 | 9030/305 | 12" | 12 ³ / ₄ " | 7 ⁷ / ₈ " | \$92 | \$108 |
| | 9030/458 | 18" | 18 ⁷ / ₈ " | 1" | 197 | 227 |
| 9040 | 9040/305 | 12" | 12 ⁷ / ₈ " | 13 ¹ / ₁₆ " | \$92 | \$108 |
| | 9040/458 | 18" | 19" | 1 ⁵ / ₁₆ " | 197 | 227 |

For full Traditions line, please see pages 16–17.

Ultima I

9006P

9007P

9009P

9013P



| Item# | Center to Center | Overall Length | Proj. | FINISHES | | NON-STOCK* | |
|----------------------------------------------|------------------|-----------------------------------|------------------------------------|---------------------------------|-----------------------------------|--------------|--|
| | | | | US15 US10B US26 | US3 US3A US4 US5 US14 | | |
| 9006P 1" w | 9006P/440 | 17 ⁵ / ₁₆ " | 17 ¹⁵ / ₁₆ " | 2" | \$227 | \$284 | |
| | 9006P/440B** | 17 ⁵ / ₁₆ " | 17 ¹⁵ / ₁₆ " | 2" | 227 | 284 | |
| 9007P 5/8" w | 9007P/400† | 17 ⁵ / ₁₆ " | 17 ¹⁵ / ₁₆ " | 2" | \$170 | \$213 | |
| 9009P 7/8" w at widest point | 9009P/415 | 16 ⁵ / ₁₆ " | 18" | 2 ⁵ / ₈ " | \$297 | \$372 | |
| | 9009P/415B** | 16 ⁵ / ₁₆ " | 18" | 2 ⁵ / ₈ " | 297 | 372 | |
| 9013P 3/4" w (not square) | 9013P/415 | 16 ⁵ / ₁₆ " | 17 ¹⁵ / ₁₆ " | 1 ⁷ / ₈ " | \$183 | \$229 | |
| | 9013P/415B** | 16 ⁵ / ₁₆ " | 17 ¹⁵ / ₁₆ " | 1 ⁷ / ₈ " | 183 | 229 | |

*Non-stock finishes require a 12-week lead time and a minimum order of \$500.00 list.

**In order to achieve back-to-back, order one regular pull and one B.

†Not available back-to-back.

For full Ultima I line, please see pages 13–15.

Suggested retail prices effective January 3, 2023.

Ultima II

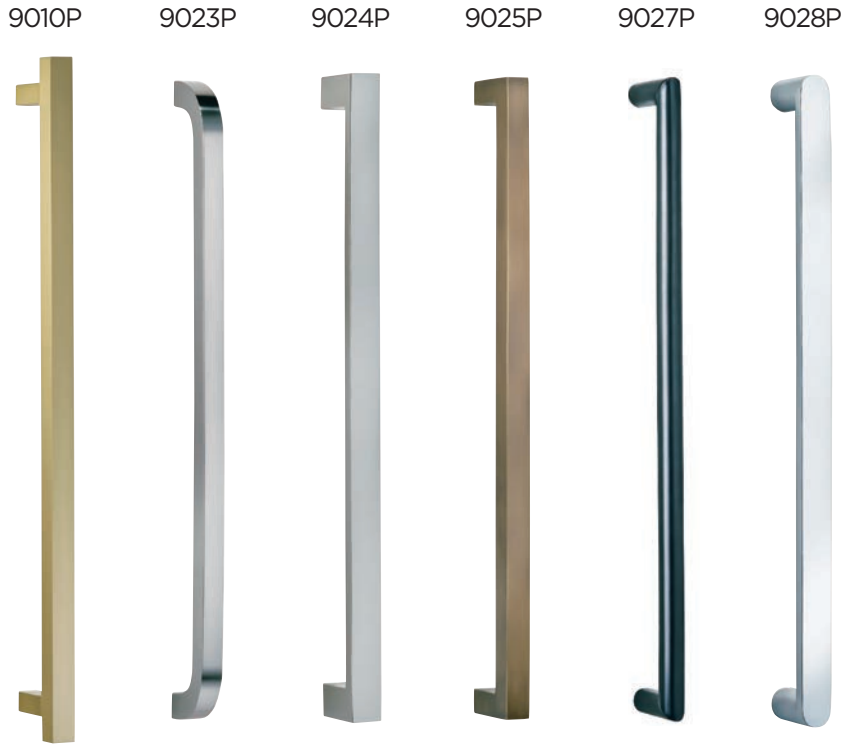

| | Item# | Center to Center | Overall Length | Proj. | FINISHES | |
|------------------------|-------------|------------------|----------------|---------|-----------------------------|--------------|
| | | | | | US4 US14 US15 US26 | US5 US10B |
| 9010P 3/4" w | 9010P/305 | 12" | 14" | 2 5/16" | \$177 | \$203 |
| | 9010P/305B* | 12" | 14" | 2 5/16" | 177 | 203 |
| | 9010P/457 | 18" | 20" | 2 5/16" | 248 | 285 |
| | 9010P/457B* | 18" | 20" | 2 5/16" | 248 | 285 |
| 9023P 5/8" w | 9023P/305 | 12" | 12 3/4" | 2 3/16" | \$172 | \$197 |
| | 9023P/305B* | 12" | 12 3/4" | 2 3/16" | 172 | 197 |
| | 9023P/457 | 18" | 18 3/4" | 2 3/16" | 238 | 273 |
| | 9023P/457B* | 18" | 18 3/4" | 2 3/16" | 238 | 273 |
| 9024P 1" w | 9024P/305 | 12" | 13" | 2" | \$154 | \$177 |
| | 9024P/305B* | 12" | 13" | 2" | 154 | 177 |
| | 9024P/457 | 18" | 19" | 2" | 206 | 237 |
| | 9024P/457B* | 18" | 19" | 2" | 206 | 237 |
| 9025P 3/4" w | 9025P/305 | 12" | 12 3/4" | 2" | \$176 | \$202 |
| | 9025P/305B* | 12" | 12 3/4" | 2" | 176 | 202 |
| | 9025P/457 | 18" | 18 3/4" | 2" | 246 | 283 |
| | 9025P/457B* | 18" | 18 3/4" | 2" | 246 | 283 |
| 9027P 3/4" w | 9027P/305 | 12" | 12 3/4" | 2" | \$139 | \$160 |
| | 9027P/305B* | 12" | 12 3/4" | 2" | 139 | 160 |
| | 9027P/457 | 18" | 18 3/4" | 2" | 194 | 224 |
| | 9027P/457B* | 18" | 18 3/4" | 2" | 194 | 224 |
| 9028P 3/4" w | 9028P/305 | 12" | 13" | 2" | \$146 | \$168 |
| | 9028P/305B* | 12" | 13" | 2" | 146 | 168 |
| | 9028P/457 | 18" | 19" | 2" | 194 | 224 |
| | 9028P/457B* | 18" | 19" | 2" | 194 | 224 |

*In order to achieve back-to-back, order one regular pull and one B.

For full Ultima II line, please see pages 10–12.

Suggested retail prices effective January 3, 2023.

Ultima III



| | Item# | Center to Center | Overall Length | Proj. | FINISHES | | | | |
|---------------------------------|-------------|------------------|----------------------------------|----------------------------------|--------------|-----|-----|-------|------|
| | | | | | US3A | US4 | US5 | US10B | US14 |
| 9029P 3/4" w | 9029P/305 | 12" | 12 ³ / ₄ " | 2 ³ / ₁₆ " | \$234 | | | | |
| | 9029P/305B* | 12" | 12 ³ / ₄ " | 2 ³ / ₁₆ " | 234 | | | | |
| | 9029P/457 | 18" | 18 ³ / ₄ " | 2 ³ / ₁₆ " | 345 | | | | |
| | 9029P/457B* | 18" | 18 ³ / ₄ " | 2 ³ / ₁₆ " | 345 | | | | |
| 9031P 3/4" w | 9031P/305 | 12" | 12 ³ / ₄ " | 2 ³ / ₁₆ " | \$249 | | | | |
| | 9031P/305B* | 12" | 12 ³ / ₄ " | 2 ³ / ₁₆ " | 249 | | | | |
| | 9031P/457 | 18" | 18 ³ / ₄ " | 2 ³ / ₁₆ " | 370 | | | | |
| | 9031P/457B* | 18" | 18 ³ / ₄ " | 2 ³ / ₁₆ " | 370 | | | | |
| 9037P 7/16" max. dia. | 9037P/305 | 12" | 12 ³ / ₄ " | 2 ¹ / ₈ " | \$234 | | | | |
| | 9037P/305B* | 12" | 12 ³ / ₄ " | 2 ¹ / ₈ " | 234 | | | | |
| | 9037P/457 | 18" | 18 ³ / ₄ " | 2 ¹ / ₈ " | 345 | | | | |
| | 9037P/457B* | 18" | 18 ³ / ₄ " | 2 ¹ / ₈ " | 345 | | | | |
| 9038P 3/4" max. dia. | 9038P/305 | 12" | 12 ³ / ₄ " | 2 ¹ / ₈ " | \$234 | | | | |
| | 9038P/305B* | 12" | 12 ³ / ₄ " | 2 ¹ / ₈ " | 234 | | | | |
| | 9038P/457 | 18" | 18 ³ / ₄ " | 2 ¹ / ₈ " | 345 | | | | |
| | 9038P/457B* | 18" | 18 ³ / ₄ " | 2 ¹ / ₈ " | 345 | | | | |
| 9039P 13/16" w | 9039P/305 | 12" | 12 ³ / ₄ " | 2 ¹ / ₈ " | \$234 | | | | |
| | 9039P/305B* | 12" | 12 ³ / ₄ " | 2 ¹ / ₈ " | 234 | | | | |
| | 9039P/457 | 18" | 18 ³ / ₄ " | 2 ¹ / ₈ " | 345 | | | | |
| | 9039P/457B* | 18" | 18 ³ / ₄ " | 2 ¹ / ₈ " | 345 | | | | |

*In order to achieve back-to-back, order one regular pull and one B.

For full Ultima III line, please see pages 6–8.

Suggested retail prices effective January 3, 2023.

Flushcups • Solid Brass & Stainless Steel

652



| | | | | |
|-------------------------|----------|-------|------|------------|
| L x W x D | FINISHES | | | |
| | US3 | US10B | US26 | US15 US26D |
| 4 3/8" x 1 9/16" x 1/2" | \$41 | \$46 | \$42 | |

653



| | | | | |
|--------------------|----------|-------|------|------------|
| L x W x D | FINISHES | | | |
| | US3 | US10B | US15 | US26 US26D |
| 4" x 1 3/4" x 1/2" | \$39 | \$52 | \$45 | \$40 |

654



| | | | |
|--------------------|----------|------|------|
| L x W x D | FINISHES | | |
| | US3 | US14 | US26 |
| | US15 | SB | |
| 4" x 1 3/4" x 1/2" | \$41 | \$47 | \$42 |

4297



| | | |
|-------------------------|----------|------|
| L x W x D | FINISHES | |
| | US3 | SB |
| 5 3/8" x 1 9/16" x 1/2" | \$91 | \$95 |

7500/65



| | | |
|---------|-------|--------|
| Dia. | Depth | FINISH |
| | | US32D |
| 2 9/16" | 5/8" | \$23 |

7501/51



| | | |
|------|-------|--------|
| Dia. | Depth | FINISH |
| | | US32D |
| 2" | 5/8" | \$21 |

7502/35



| | | |
|--------|-------|--------|
| Dia. | Depth | FINISH |
| | | US32D |
| 1 3/8" | 1/2" | \$28 |

7503/52



| | | | | |
|---------|------|----------|------|-------|
| Dia. | D | FINISHES | | |
| | | US3 | SB | US32D |
| | | US10B | US14 | |
| | | US15 | US26 | |
| 2 3/16" | 3/8" | \$51 | | \$16 |

7504/52



| | | | |
|---------|-------|----------|-------|
| Dia. | Depth | FINISHES | |
| | | US3 | US32D |
| | | US10B | |
| | | US14 | |
| | | US15 | |
| | | US26 | |
| | | SB | |
| 2 3/16" | 3/8" | \$51 | \$16 |

7505/120



| | |
|-------------------------|--------|
| L x W x D | FINISH |
| | US32D |
| 4 3/4" x 1 9/16" x 1/2" | \$21 |

7506/100



| | |
|----------------|--------|
| L x W x D | FINISH |
| | US32D |
| 4" x 2" x 1/2" | \$21 |

7507



| | | |
|---------|---------|--------|
| Dia. | Depth | FINISH |
| | | US32D |
| 3 9/16" | 1 3/16" | \$28 |

Suggested retail prices effective January 3, 2023.

Pocket Door Flushcups • Solid Brass & Stainless Steel

7012



L x W x D
5" x 2 1/4" x 1/2"
Proj. 3/32"
US32D **\$79**



US32D

7035



L x W x D
7" x 2 9/32" x 3/8"
Proj. 3/32"
ALL FINISHES **\$103**

7036



L x W x D
4 1/2" x 2 9/32" x 3/8"
Proj. 3/32"
ALL FINISHES **\$79**

7037



L x W x D
7" x 2 9/32" x 7/16"
Proj. 1/8"
ALL FINISHES **\$103**

7039



L x W x D
7" x 2 9/32" x 7/16"
Proj. 1/8"
ALL FINISHES **\$103**



US3 US3A US4 US5 US10B US14 US15 US26 US26D

Drop Rings & Flushcup • Solid Brass

9580



| Item# | Dia. | Depth | FINISHES | | |
|---------|------|-------|-------------|-------------|----|
| | | | US3 | US4 | SB |
| 9580/50 | 2" | 3/8" | \$24 | \$28 | |

9588



| Item# | L x W x D | FINISHES | | |
|---------|------------------------|-------------|-------------|----|
| | | US3 | US4 | SB |
| 9588/60 | 2 3/8" x 1 7/8" x 3/8" | \$23 | \$28 | |

9595

D/O - Discontinued when out of stock.



| Item# | Dia. | Depth | FINISHES | | |
|---------|--------|-------|-------------|-------------|-------------|
| | | | US3 | US4 | SB |
| 9595/50 | 2" | 1/2" | \$19 | \$21 | \$19 |
| 9595/60 | 2 3/8" | 9/16" | 23 | 28 | 24 |

Suggested retail prices effective January 3, 2023.

Door Stops • Solid Brass & Stainless Steel

1147



| Proj. | FINISHES | | | |
|-------|-------------|---------------|-------------|-------------|
| | US3 US26 | US15 US26D | US10B SB | |
| 3" | | | | \$18 |

1148



| Proj. | FINISHES | | | |
|--------|-------------|---------------|-------------|-------------|
| | US3 US26 | US15 US26D | US10B SB | |
| 3 3/4" | | | | \$20 |

2001



D/O - Discontinued when out of stock.

| Throw | Overall Length | Max. Width | FINISHES | |
|-------|----------------|------------|-------------|--|
| | | | US3 | |
| 2" | 7 1/16" | 1 1/8" | \$48 | |

Plunger Door Holder

Operates by stepping on plunger, which is fitted with a white rubber tip. Hold door firmly in any position. Releases by stepping on trigger plate.

7001



| Dia. | Ht. | FINISHES | | | |
|------|---------|-------------------------------|---------------------------|-------------|-------------|
| | | US3 US10B US15 US26D | US4 US14 US26 SB | US32D | PVD |
| 7/8" | 1 3/16" | | \$29 | \$19 | \$28 |

7602/35



| Dia. | Ht. | FINISH |
|------|---------|-------------------|
| 1" | 1 1/16" | US32D \$41 |

7605/87



| Dia. | Proj. | FINISH |
|------|-------|-------------------|
| 1" | 3/4" | US32D \$61 |

7610



| Item# | Dia. | Ht. | FINISH |
|---------|------|--------|-------------------|
| 7610/35 | 1" | 1 3/8" | US32D \$21 |
| 7610/51 | 1" | 2" | \$33 |

7000



| Item# | Dia. | Ht. | FINISHES | | | |
|---------|---------|----------|----------------------|---------------------------|-------------|-------------|
| | | | US3 US26 US26D | US4 US14 US15 SB | US32D | PVD |
| 7000 | 1 1/16" | 1 11/16" | \$39 | \$45 | \$29 | \$42 |
| 7000/55 | 1 1/16" | 2 3/16" | N/A | N/A | 39 | N/A |

7620/35



| Sq. | Ht. | FINISH |
|-----|--------|-------------------|
| 1" | 1 3/8" | US32D \$51 |

Ball Catch • Solid Brass

1600F



Faceplate: 2 1/8" L x 1" W
Strike Plate: 2 1/8" L x 1 3/8" W
Barrel: 3/4" Dia. x 1 1/4 L

| Item# | FINISHES | | | |
|-------|-------------|-------------|----------------|------------|
| | US3 US15 | US4 US26 | US10B US26D | US14 SB |

1600F* 1600F **\$31**
Ball Catch

*Ball projection is adjustable.

Suggested retail prices effective January 3, 2023.

Latch & Decorative Hooks • Solid Brass

156



Not Handed

| | Height | Lever Width | FINISHES | |
|--------------------------------------------------------|--------|---------------------------------|-------------|------|
| | | | US3 | US26 |
| 156 Shutter Latch / Bi-fold Door Latch | 2" | 2 ³ / ₈ " | \$26 | |

210



| | Height | Proj. | FINISHES | |
|------------------------------|--------|-------|-------------|------|
| | | | US3 | US26 |
| 210 Double Hook | 3" | 3" | \$26 | |

212



| | Height | Proj. | FINISHES | |
|--------------------|---------------------------------|----------------------------------|-------------|------|
| | | | US3 | US26 |
| 212 Hook | 1 ⁵ / ₈ " | 1 ⁵ / ₁₆ " | \$15 | |

213



| | Height | Proj. | FINISHES | |
|------------------------------|---------------------------------|-------------------------------|-------------|------|
| | | | US3 | US26 |
| 213 Double Hook | 1 ¹ / ₂ " | ³ / ₄ " | \$15 | |

215



D/O - Discontinued when out of stock.

| | Base | Proj. | FINISH |
|----------------------------------------|-------------------------------------------------------------------|----------------------------------|--------------|
| | | | US3 |
| 215 Triple Swivel Hook | 3 ¹ / ₂ " x 1 ³ / ₄ " | 4 ⁵ / ₁₆ " | \$141 |

Suggested retail prices effective January 3, 2023.

Switchplates • Solid Brass

8004



8004/S SINGLE



8004/D DOUBLE

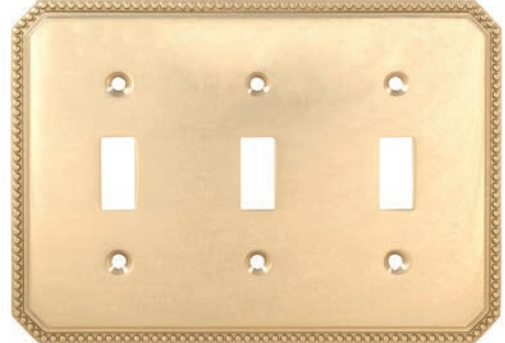

8004/T TRIPLE

D/O - Discontinued when out of stock.



8004/R DUPLEX RECEPTACLE



8004/C COMBINATION

| Item# | FINISHES | | |
|---------------|----------|------|---------|
| | US3 | US15 | US26 SB |
| 8004 | | | |
| Beaded Design | | | |
| 8004/S | \$29 | \$34 | \$32 |
| 8004/D | 42 | 47 | 46 |
| 8004/T* | 52 | 58 | 54 |
| 8004/R | 29 | 34 | 32 |
| 8004/C | 42 | 47 | 46 |

*Discontinued when out of stock.

8005



8005/S SINGLE



8005/D DOUBLE

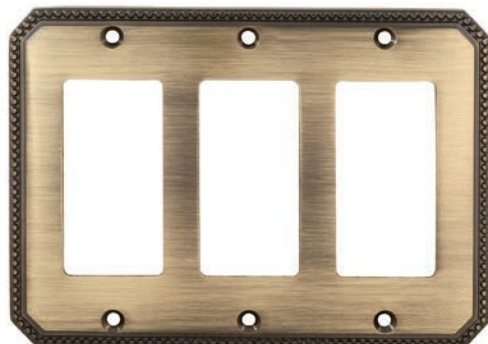

8005/T TRIPLE

D/O - Discontinued when out of stock.

| Item# | FINISHES | | |
|---------------|----------|------|---------|
| | US3 | US15 | US26 SB |
| 8005 | | | |
| Beaded Design | | | |
| 8005/S | \$29 | \$34 | \$32 |
| 8005/D | 42 | 47 | 46 |
| 8005/T* | 52 | 58 | 54 |

*Discontinued when out of stock.

Suggested retail prices effective January 3, 2023.

Switchplates • Solid Brass

8012



8012/S SINGLE



8012/D DOUBLE



8012/T TRIPLE

D/O - Discontinued when out of stock.



8012/R DUPLEX RECEPTACLE



8012/C COMBINATION

| Item# | FINISHES | | |
|-------------|----------|------|---------------|
| | US3 | US15 | US26 US26D |
| 8012 | | | |
| 8012/S | \$28 | \$32 | \$29 |
| 8012/D | 40 | 46 | 41 |
| 8012/T* | 50 | 55 | 52 |
| 8012/R | 28 | 32 | 29 |
| 8012/C | 40 | 46 | 41 |
| 8012/GFS | 41 | 47 | 45 |

*Discontinued when out of stock.

8023



8023/S SINGLE



8023/D DOUBLE



8023/T TRIPLE

D/O - Discontinued when out of stock.

| Item# | FINISHES | | |
|-------------|----------|------|---------------|
| | US3 | US15 | US26 US26D |
| 8023 | | | |
| 8023/S | \$27 | \$32 | \$29 |
| 8023/D | 40 | 46 | 41 |
| 8023/T* | 50 | 55 | 52 |

*Discontinued when out of stock.

Suggested retail prices effective January 3, 2023.

Switchplates • Solid Brass

8014



8014/S SINGLE



8014/D DOUBLE



8014/T TRIPLE

D/O - Discontinued when out of stock.



8014/R DUPLEX RECEPTACLE



8014/C COMBINATION

| Item# | FINISHES | | |
|---------------------------|----------|------|---------------------|
| | US3 | US15 | US26 US26D SB |
| 8014 | | | |
| Traditional Design 8014/S | \$29 | \$32 | \$31 |
| 8014/D | 41 | 47 | 45 |
| 8014/T* | 51 | 57 | 53 |
| 8014/R | 29 | 32 | 31 |
| 8014/C | 41 | 47 | 45 |

*Discontinued when out of stock.

8024



8024/S SINGLE



8024/D DOUBLE

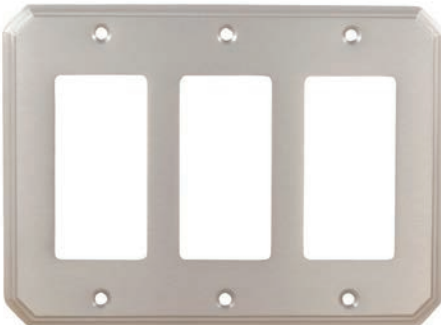

8024/T TRIPLE

D/O - Discontinued when out of stock.

| Item# | FINISHES | | |
|---------------------------|----------|------|---------------------|
| | US3 | US15 | US26 US26D SB |
| 8024 | | | |
| Traditional Design 8024/S | \$29 | \$32 | \$31 |
| 8024/D | 41 | 47 | 45 |
| 8024/T* | 51 | 57 | 53 |

*Discontinued when out of stock.

Suggested retail prices effective January 3, 2023.

OMNIA TERMS & CONDITIONS OF SALE

(as of January 3, 2023)

WARRANTIES

Limited Mechanical Warranty

OMNIA Industries, Inc. ("OMNIA") offers to the original owner a Limited Warranty that all OMNIA products shall be free of mechanical abnormality for the duration that the original owner inhabits the residence in which the product was originally installed.

Exclusions

Any OMNIA product having an abnormality due to improper installation, forced entry, failure to exercise normal maintenance or against the consequences of uses for which our products were not designed is not covered by this warranty. Additionally, if an OMNIA product or component part is used with a product that is not ours or a component part (such as an OMNIA lock or latch with non-OMNIA knobs, levers, escutcheons and roses), any warranty shall be null and void. Warranty does not cover normal wear and tear.

FINISH WARRANTIES

(Includes General Maintenance)

Stainless Steel

OMNIA warrants its stainless steel finish shall be free from abnormalities in material and workmanship from tarnishing or rusting for either five (5) years from date of purchase for interior use or one (1) year from the date of purchase on exterior doors only for the duration that the original owner inhabits the residence in which the product was originally installed. Exposure to certain chemical or environmental conditions may promote surface oxidation. Please be aware that this is not an abnormality in the stainless steel but a reaction on the surface of the finish to the chemical environment which can be removed with a stainless steel polish or an abrasive pad. **Surface oxidation is not considered an abnormality in the product.**

Stainless Steel PVD

The OMNIA PVD finishes use an advanced finishing technology (Physical Vapor Deposition) to create a finish highly resistant to the effects of weather and normal use. For OMNIA products purchased with PVD finishes, OMNIA warrants the finish shall be free from abnormalities in materials and workmanship from tarnishing, flaking or pitting for the **Lifetime** of the applicable product for the duration that the original owner inhabits the residence in which the product was originally installed. Although the OMNIA PVD finishes are highly resistant to the effects of weather and normal use, they do require periodic maintenance. A build-up may occur if it is not performed, which may create a haze or darker look to the finish. This is neither tarnish nor an abnormality in the PVD finish. OMNIA PVD finishes can be maintained simply by wiping with a soft cloth and glass cleaner; or as an alternative, a non-abrasive metal polish which can be purchased at any hardware store. Rubbing alcohol may also be used to clean the surface of PVD finishes. **DO NOT use metal polishes that contain abrasives.**

Remaining Finishes

OMNIA warrants its finishes (excluding unlacquered finishes, stainless steel and

stainless steel PVD) shall be free from abnormalities in materials and workmanship from tarnishing, flaking or pitting for either five (5) years from date of purchase for interior use, or one (1) year from the date of purchase for use on exterior doors only for the duration that the original owner inhabits the residence in which the product was originally installed. Only use a damp cloth to clean surface of finish to remove dirt and grime. **DO NOT use household cleaners and/or chemicals.**

Exclusions

Any OMNIA product having an abnormality due to neglect, misuse, abuse or unreasonable or extraordinary use or lack of normal maintenance is not covered by this warranty. In addition, any OMNIA product having an abnormality due to use of paints, solvents or other chemicals is not covered by this warranty. Discontinued products will not be covered by any warranty. Finishes will not be warranted for any OMNIA product installed on an exterior metal door.

FOR ALL WARRANTIES, PLEASE NOTE: OMNIA is not responsible for labor charges related to installation, repair or replacement of any product under this warranty. OMNIA's liability under this warranty shall not exceed the sale price of the product.

PRICES

Prices are subject to change without notice. Invoices will reflect prices in effect at the time of shipment. OMNIA is not responsible for errors and/or omissions which may appear in any printed material. Orders held by OMNIA because of credit status may be repriced to pricing in effect on date of order release by OMNIA Credit Department.

RETURNED GOODS

Products must be returned within 60 days of original invoice date. There is a minimum 25% restock fee, plus a freight charge, for all unused and undamaged items returned in original condition. All returns must be accompanied with a completed Return Goods Form (RGF). Any return which exceeds \$1,000 net requires prior authorization. If a factory defect is claimed, please contact OMNIA for replacement or authorization. Any credit due will be determined upon inspection. Reordered or replacement materials will be billed when shipped. Returns will be credited after inspection and approval. All returns must be shipped freight prepaid. COD returns will be refused. Special order or discontinued items will not be accepted for return.

ORDERS & SPECIFICATIONS

OMNIA has the right to not accept orders in part or whole if the quantity, finishes or prices requested are not suitable. Packing, weights, measurements and designs are subject to change without notice. All special factory orders are non-cancelable, non-returnable and non-refundable.

ORDER CHANGES

If there are items not readily available, OMNIA will ship and backorder. Items temporarily out of stock will be backordered and so indicated on invoice. Backorders must be canceled prior to shipment of product. Orders canceled after

shipment from OMNIA will incur freight charges and a 25% restocking charge. Address changes after shipment will incur freight charges.

DISCONTINUED ITEMS & D/O

OMNIA may discontinue product or alter specifications at any time without prior notification or obligation. D/O designates a product which will continue to be available as long as inventory remains, after which the product will be discontinued. This program is intended to help our customers anticipate future needs and to avoid bidding or taking orders on parts which may not be available in sufficient quantities when needed.

SHIPMENTS

Smaller orders, shipments destined outside the US borders, and **all specially quoted contract orders are shipped FOB Cedar Grove, NJ.** Cremona bolt orders do not qualify for prepaid shipments. Freight charges will apply to contract orders. Please refer to job quote. There will be a handling fee in addition to freight charges. (Drop ship orders incur a higher handling fee.) In certain instances, a fee for insurance coverage may be added. OMNIA will select the quickest and best routes available. Consignee assumes risk of loss or damage after shipments have been delivered to carrier. Claims must be filed with the transportation company. We cannot accept consignee or third party billing for any shipment.

OPEN ACCOUNTS

Established accounts will be maintained on open account terms as long as payments are kept current. New accounts must submit proper trade and bank references.

SAMPLE PROGRAM

Cabinet Hardware

Samples of cabinet pulls up to 6" and cabinet knobs up to 1 1/4" dia. are available free of charge with a \$10 shipping fee for each item ordered. A maximum of 3 samples can be ordered. If ordering more than one sample, the additional samples must all be different part numbers.

Door Hardware

Single dummy samples of door knobs and levers with a list price value up to \$75 are available free of charge with a \$20 shipping fee for each item ordered. For single dummy samples with a list price value of \$76 and over, there is a \$30 shipping fee for each item ordered.

For each sample ordered, you will receive a discount coupon in the amount of the shipping fee. For each \$100 list purchase made through an authorized OMNIA dealer, you may apply one discount coupon. Since there is no charge for the product samples themselves, they cannot be returned to OMNIA for product credit.

If you are interested in a sample of a product other than cabinet hardware or single dummies, please contact OMNIA for shipping costs.

An Authorized OMNIA dealer may request a complete Dealer Terms & Conditions by emailing info@OMNIAindustries.com.



OMNIA
SINCE 1964

5 Cliffside Drive • Box 330
Cedar Grove, New Jersey 07009
tel 973.239.7272
Email: orders@OMNIAindustries.com
www.OMNIAindustries.com

