



**Corbin
Russwin**

ASSA ABLOY



2025 Price List

Number 40

USA & Canada Prices Effective March 3, 2025



Experience a safer
and more open world

SECTION	PAGE
Service Center Business Hours, Holiday Schedule	5
Partner Services in Canada, Business Hours, Holiday Schedule	5
Order Forms	6
Key System Information Request Form	10
Keyed Order Lead Sheet	11
Tools and Rules	14
Terms and Conditions	15
Limited Warranty	20
Cylinder Service Fee	21
Finishes, Samples, Templates	22
KEY SYSTEMS	
General Information	24
Policy	27
Construction Core	28
Keying, Stamping, Cut Keys	29
Bitting List	30
Simple K	31
Key Blanks	32
Access 3 AP Security Cylinders	34
Pyramid Cylinders	40
Conventional Cylinders	46
Interchangeable Core Cylinders	54
Security Cylinders	60
Master Ring Cylinders	66
Service Equipment	69
MORTISE LOCKSETS AND TRIM	
MicroShield® How to Order	72
ML2000 Series / Muséo Levers & Inspire Trim, Roses & Thumbturns, Escutcheons	73
Vineyard™ Collection	88
Vandal Resistant Trim	90
ML20900 Series & ML20600 NAC Series / Muséo Levers	91
Cylinder and Keying Options	110
Miscellaneous Options	113
HEALTHCARE HARDWARE	
MicroShield® Healthcare Hardware Finishes, How to Order, Pricing	116
CLX3300 Series Behavioral Health Series™ Lever Design: BHSS	117
CLX3300 Series Cylinder and Miscellaneous Options	118
ML2000 Series Behavioral Health Series™ Lever Design: BHSS	122
ML2000 Series Behavioral Health Series™ Lever Design: BLSS	123
ML2000 Series Anti-Harm Knob Trim Knob Design: HSS	124
ML2000 Series Healthcare Hardware HPSK Trim	125
ML2000 Series Cylinder and Miscellaneous Options	126
HP3000 Series Tubular Lock with Push/Pull Trim, Features & Ordering Example	129
HP3000 Series Strike, Door Thickness, Backset, Miscellaneous Options	130

CYLINDRICAL LOCKS	PAGE
MicroShield® How to Order	132
TL3700 Series: Muséo Levers & Inspire™ Trim, Levers & Roses, Options	133
CL3100 Series Grade 1 Vandal Resistant Cylindrical Lever Locksets	138
CLX3300 Series Grade 1 Heavy-Duty Cylindrical Lever Locksets	144
CL3800 Series Grade 2 Standard-Duty Lever Locksets	151
CK4300 Series Grade 1 Cylindrical Knob Locksets	155
CK4800 Series Grade 2 Cylindrical Knob Locksets	158
PRE-ASSEMBLED UNIT LOCKSETS	
UT5200 Series	162
AUXILIARY HARDWARE	
PL5000 Series Padlocks	127
DL2200 Series Cylindrical Deadlocks	169
DL3000 Series Cylindrical Deadlocks	172
DL3200 Series Cylindrical Deadlocks	173
DL4100 Series Mortise Deadlocks	178
MULTIPOINT LOCKS	
FE5400S	183
MP6600	197
FE6600	210
BL6600	223
FE6700	236
MP9800	240
EXIT DEVICES	
MicroShield® Technology	256
ED2000 Pushpad Series	257
ED3000 Crossbar Series	266
PED4000 Narrow Stile Pushpad Series	278
PED5000 Pushpad Series	292
ED4000 Narrow Stile Pushpad Series / Muséo Levers with 800 Series Escutcheon	312
ED5000 Pushpad Series / Muséo Levers with 900 Series Escutcheon	326
ED7000 Narrow Stile Crossbar Series	351
DOOR CLOSERS	
DC3000 Series	362
DC5200 Cam Action Door Closer	364
DC6000 Series	366
DC8000 Series	370
DC62900 Series	374

Continued on next page.

PARTS	PAGE
Key Systems	
Plugs and Shells	376
Cylinder Parts	377-378
Standard Diameter Cylinder Collars	379
Master Ring Cylinder Collars	380
Tools	381
Mortise Locksets and Trim	
ML2000 Series – Mortise Locks	382-383
ML2000 Series – Mortise Trim	384-392
Vandal Resistant Cylindrical Lever Locksets	
CL3100 Series	393-395
Extra Heavy-Duty Cylindrical Lever Locksets	
CLX3300 Series	396-400
Extra Heavy-Duty Cylindrical Lever Locksets	
CL3300 Series	401-404
Heavy-Duty Cylindrical Lever Locksets	
CL3500 Series	405-406
Grade 2 Key-In-Lever	
CL3800 Series	407-408
Heavy-Duty Cylindrical Knob Locksets	
CK4300 Series	409
Standard-Duty Cylindrical Knob Locksets	
CK4800 Series	410
Pre-Assembled Unit Locksets	
UT5200 Series	411-412
Padlocks, Deadlocks and Push-Pull Latches	
Padlocks	413
DL4100 Series Deadlock Parts	413
DL3000 Series Deadlocks	413
PED4000 and PED5000 Series Exit Devices	
Strikes and Shim Kits	413
ED4000 and ED5000 Series Exit Devices	
Device Parts	414-416
Trim Parts	417-418
Crossbar Exit Devices and Trims	
ED7000 Series	419-423
Door Closers	
DC3000 Series	424
DC5200 Cam Action Door Closer	424
DC6000 Series	425
DC8000 Series	426
Electronic Hardware Parts	
DC62900 Series	427
Access 800® AC2 Series	427
Parts Index	428-439

BUSINESS HOURS

**ASSA ABLOY CUSTOMER SERVICE
– CORBIN RUSSWIN**

8:00 a.m – 4:30 p.m. (Eastern)
 225 Episcopal Road
 Berlin, CT 06037-4004
 Telephone: (800) 438-1951
 Fax: (888) 338-0965
 customerservice.corbinrusswin@assaabloy.com
 orders.corbinrusswin@assaabloy.com

TECHNICAL PRODUCT SUPPORT

8:00 a.m – 4:30 p.m. (Eastern)
 Telephone: (800) 543-3658
 techsupport.corbinrusswin@assaabloy.com

ELECTRIFIED TECHNICAL PRODUCT SUPPORT

8:00 a.m – 4:30 p.m. (Eastern)
 Telephone: (800) 810-WIRE (9473)
 Fax: (203) 603-5981

SPECIFIC WHO'S WHO CONTACTS

<https://go.corbinrusswin.com/whoswho>

**ASSA ABLOY DOOR SECURITY SOLUTIONS
CANADA CUSTOMER SERVICE – VAUGHAN**

8:00 a.m – 4:30 p.m. (Eastern)
 160 Four Valley Drive
 Vaughan ON L4K4T9
 Telephone: (800) 461-3007
 Fax: (800) 461-8989

HOLIDAY SCHEDULE*

ASSA ABLOY Door Security Solutions Customer Support Services – Corbin Russwin will be CLOSED on the following holidays:

- January 1, 2025
- January 20, 2025
- March 3, 2025
- April 18, 2025
- May 26, 2025
- July 4, 2025
- September 1, 2025
- November 27-28, 2025
- December 24-26, 2025

*Dates subject to change

ASSA ABLOY Door Security Solutions Customer Service - Vaughan

- January 1, 2025 New Year's Day
- March 3, 2025..... Family Day
- April 18, 2025.....Good Friday
- May 19, 2025Victoria Day
- July 1, 2025.....Canada Day
- August 4, 2025Civic Holiday
- September 1, 2025Labour Day
- October 13, 2025Thanksgiving Day
- December 24-25, 2025Christmas Day
- December 26, 2025Boxing Day
- December 31, 2025New Year's Eve

Technical Product Support will be CLOSED on the following holidays:

- January 1, 2025
- January 20, 2025
- March 3, 2025
- April 18, 2025
- May 26, 2025
- July 4, 2025
- September 1, 2025
- November 27-28, 2025
- December 24-26, 2025



ASSA ABLOY

Date: _____

KEY SYSTEMS INFORMATION

*Registry Number: _____

*Job Name and Location: _____

*Keyway: _____ Top Master Key Bitting: _____

Any Other Known System Information:

Information Requested:

Requested By: _____

Phone: _____ Fax: _____ Email: _____

Agency/Distributor Name: _____

Key System Administration Response:

Please attach a Letter of Authorization from the end user if requesting bitting information.

***Required Information**

Note: Only One Leadsheet/Key System Per Purchase Order

*Required Information

Acc#* : _____ Distributor Name* : _____ P.O. #* : _____

End User Facility Name* : _____ Contact Name: _____

Job/Building Name* : _____ Phone/email: _____

End User Address* : _____

City* : _____ State* : _____ Zip Code* : _____

Section 1: System Status

New

Existing (provide any below)

REG#** : _____ TMK Biting and Keyway ** : _____ Prior Order #** : _____

**Used to locate proper Registry # ONLY. All other order requirements must be identified in sections below.

For Order with Field Specified Bittings provide information with PO. See Price Book for possible extra charges.

Section 2: System Type and Design (For New Systems ONLY)

Select System Type, Number of Pins and Level of System and add required future expansions horizontally.

To Select Cylinder Features See Section #6

For Actual Cut Key quantities see Section #7

System 70
(Standard, Security)

Pre System 70

ACCESS 3
(AP, AS and AHS)

Pyramid

5 Pins

6 Pins

7 Pins

Expansions →	Number of Change Keys	Number of Masters	Number of Grand Masters	Top Master Key Level
Level 1 <input type="checkbox"/>		—	—	—
***Level2 <input type="checkbox"/>		—	—	Master
Level3 <input type="checkbox"/>			—	Grand
Level4 <input type="checkbox"/>				Great Grand

*** For Level 2 systems ONLY, the Numbers in the Keyset Symbol comes **before** the Letters (Example: **1AA, 2AA, 3AA...**)

Section 3: KEYWAY

Corbin Russwin Manufacturing will assign keyways unless customer specific keyway is noted below.

Use of restricted keyways (39, 93, F and J) require pre-approval by Corbin Russwin

Customer Specified keyway: _____

Section 4: CROSS KEYING

All Cross Keyed Cylinders need to have keysets with leading "X" on P.O. Example: XAA1

For all Cross Keyed Cylinders, Keysets Operated By (OBY) conditions need to be provided below.

Keyset	Operated By Conditions	Keyset	Operated By Conditions

Section 5: AUTHORIZATION

Access 3 AS/AHS and Pyramid Products Require Authorization

For **NEW** Access3 and Pyramid systems include the System Information Document with your P.O.

[Click here for template](#)

For **EXISTING** systems, if cylinders, keys, keyblanks or biting lists are NOT shipping directly to end user, please provide authorization documents in the form of Letter of Authorization (LOA) or through the ROA Portal

Access 3 Job ID# _____ Access 3 Random Security Code _____

P.O. #* : _____

Section 6: CYLINDER FEATURES

Cylinder Features such as CMK, LFIC, etc. and/or Security Features such as AS & AHS etc. needs to be identified on P.O. Whichever is selected below will be set up in MK system; however it will NOT be applied by Corbin Russwin to a product on a P.O.

Feature	Set it up	Feature	Set it up
Large Format Interchangeable Core - LFIC	<input type="checkbox"/>	Construction Lost Ball - CMK	<input type="checkbox"/>
Hotel Function	<input type="checkbox"/>	Access 3 Angles (AS & AHS)	<input type="checkbox"/>

Section 7: CUT KEYS QUANTITIES FOR CURRENT PO

 Two (2) Cut Change Keys come standard per lock/exit/cylinder. Key Blanks cannot be substituted for cut keys
 Exception to above: NO cut keys provided when keyed to Master Key only or XnX type of cross keying

Level	Keyset	Qty	Special Functions	Qty	Change Keys	Qty
GGM	_____	_____	MK Control (CTR)	_____	Per Cylinder	_____
Grand Masters	_____	_____	SKD Control (CTR)	_____	When left blank two (2) keys by default	
	_____	_____	MK Construction (CMK)	_____	Total Keys Per Keyset	_____
	_____	_____	SKD Construction (CMK)	_____	If different quantities per Keyset are required please provide below.	
	_____	_____	MK Hotel (EMK)	_____	Keyset	Qty
	_____	_____	SKD Hotel (EMK)	_____	_____	_____
Masters	_____	_____	HKP (Housekeeping)	_____	_____	_____
	_____	_____	SEC (Security)	_____	_____	_____
	_____	_____	JAN (Janitor)	_____	_____	_____
	_____	_____	MAINT (Maintenance)	_____	_____	_____
	_____	_____	ENG (Engineering)	_____	_____	_____
	_____	_____		_____	_____	_____
	_____	_____		_____	_____	_____
	_____	_____		_____	_____	_____
	_____	_____		_____	_____	_____
	_____	_____		_____	_____	_____
	_____	_____		_____	_____	_____
	_____	_____		_____	_____	_____
	_____	_____		_____	_____	_____
	_____	_____		_____	_____	_____
	_____	_____		_____	_____	_____

Section 8: STAMPING REQUIREMENTS

 Default stamping will apply unless specified below.
 Potential charges and additional lead times may apply. See Price Book
 Any DIE stamp that is selected will apply to keyblanks on the P.O. If NOT required, mark P.O. accordingly.

Cut Keys Stamping		
VKC Stamping (select one)	DIE Stamping	KEY BOW
<input type="checkbox"/> BITTING	<input type="checkbox"/> DO NOT DUPLICATE (DND)	STYLE _____
<input type="checkbox"/> KEYSET	<input type="checkbox"/> US GOVERNMENT DND	
<input type="checkbox"/> ALTERNATE	<input type="checkbox"/> US PROPERTY DND	
<input type="checkbox"/> NONE. BLANK	<input type="checkbox"/> EXISTING _____ <input type="checkbox"/> NEW _____	
<input type="checkbox"/> LESS LOGO	<input type="checkbox"/> LESS KEYWAY	

Cylinders Stamping	
VKC Stamping (select one)	Location (select one)
<input type="checkbox"/> BITTING	<input type="checkbox"/> VISUAL
<input type="checkbox"/> KEYSET	<input type="checkbox"/> CONCEALED
<input type="checkbox"/> ALTERNATE	
<input type="checkbox"/> LESS LOGO	

P.O. #* : _____

Section 9: PACKING INSTRUCTIONS FOR KEYS PRODUCED with PRODUCT
When ordered as CMK keys will be packed and shipped separately from product at no charge

- Pack Keys with Product (Standard) Pack Keys Separately - see Price Book for charges

Section 10: SHIPPING INSTRUCTIONS FOR CHANGE KEYS

Name: _____ Address: _____

Att To: _____ City: _____ State: _____ Zip: _____

Section 11: SHIPPING INSTRUCTIONS FOR ANY LEVEL MASTER KEYS
(Includes GGGM, GGM, GM, Masters, Sub Masters, Control and Emergency Keys)

Name: _____ Address: _____

Att To: _____ City: _____ State: _____ Zip: _____

Section 12: SHIPPING INSTRUCTIONS FOR CONSTRUCTION MASTER KEYS (MK'ed or TEMPs)

Name: _____ Address: _____

Att To: _____ City: _____ State: _____ Zip: _____

Section 13: SHIPPING INSTRUCTIONS FOR KEYBLANKS

Name: _____ Address: _____

Att To: _____ City: _____ State: _____ Zip: _____

Section 14: SHIPPING INSTRUCTIONS FOR CORES

Name: _____ Address: _____

Att To: _____ City: _____ State: _____ Zip: _____

Section 15: SHIPPING INSTRUCTIONS FOR BITTING LIST

If Bitting List is required, please mark how you want to receive them and provide shipping instructions

- Include Keysets that were ordered with product on this PO (no charge)
 Expanded bitting list. See Price Book for additional charges (Please provide requirements): _____

- Excel (via EMAIL) PDF (via EMAIL) Paper (via UPS)

E-mail: _____ Att To: _____

Name: _____ Address: _____

Att To: _____ City: _____ State: _____ Zip: _____

Section 16: SHIPPING INSTRUCTIONS FOR KEY WIZARD or SIMPLE K DOWNLOAD FILES

Download files are delivered via email.

If Download file is required, please mark below and provide shipping instructions

- Include Keysets that were ordered with product on this PO
 Expanded list (Please provide requirements): _____

E-mail (for download files) _____

Section 17: CONTACT INFORMATION FOR INDIVIDUAL COMPLETING THIS FORM

Name: _____

Phone: _____

E-mail: _____

Ordering Tips

- Please submit **Quick Ship Program Orders** and **Plant Product Orders** on separate order forms.
- Please use **Quick Ship Program Forms** for all **Quick Ship Product Orders** and include **Quick Ship Part Numbers**.
- **Order Forms** are included in the Price Book and at www.corbinrusswin.com.
- We recommend using the **Order Form** included with this Price Book when placing purchase orders for Corbin Russwin products. The **Order Form** is available for copying prior to placing your order.
- Please include **Job Name and Registry Number** for all contract orders.
- Be sure to include **Voltage** on all Electrified Hardware orders.
- **A Letter of Authorization** is required for all security and high security (ACC3, System 70 HS) and Pyramid products.
- **Keying Lead Sheets** are required for all master keyed orders.
- Remember to include **Keysets** on all contract orders.
- Be sure to include **Handing** for all unit locks, mortise locks and exit devices.

Ordering Tip — Administrative Documentation

When submitting purchase orders to ASSA ABLOY Door Security Solutions® Consultants for processing, please remember that certain cylinder types and/or keyways require additional administrative documentation before the order can be entered.

Purchase orders will be held and questioned if the following keyway/cylinder types do not have the proper administrative documentation submitted with each purchase order:

- Pyramid keyway products
- Security cylinders and keys
- High security cylinders and keys

All of the above product types must be accompanied by additional administrative documents unless they are shipping direct to the end user facility. These administrative documents include, but may not be limited to, the following:

- Letter of Authorization – must be submitted on the end user facility letterhead, dated and signed by an authorized individual from the facility. Letter must be quantity specific for certain product types. ASSA ABLOY Door Security Solutions Consultants does not keep letters of authorization on file.

Ordering Checklist

Before placing your order, check for the following:

- ✓ Purchase Order on company letterhead
- ✓ Purchase Order is legible
- ✓ Purchase Order Number
- ✓ Account Number
- ✓ Ship To Address
- ✓ Contact Person for additional information requirements
- ✓ Pricing Requirements – Buying Program or CPQ (please attach)
- ✓ Quick Ship Order (Quick Ship Order Form or Quick Ship part numbers included)
- ✓ Contract Order (Keyed Lead Sheets attached)
- ✓ Handing (if applicable)
- ✓ Design (if applicable)
- ✓ Backset & Strike (if applicable)
- ✓ Finish (if applicable)

Terms and Conditions

ACCEPTANCE

Corbin Russwin reserves the right to decline an order, in whole or in part, when the type or quantity of goods or credit worthiness of the Purchaser is not satisfactory to us in our sole and absolute discretion.

Purchase Orders, Quote Requests, Acknowledgments or the like issued by the Purchaser that have contrary standard terms and conditions are not binding on Corbin Russwin, unless such terms and conditions are approved in a separate written agreement by Corbin Russwin's authorized representatives. In the event of an acceptance of Purchaser's Purchase Order by Corbin Russwin, the Purchaser agrees that such acceptance is solely conditioned on Purchaser's acceptance of the terms and conditions set forth in this instrument, regardless of the terms and conditions specified in Purchaser's Purchase Order. The terms and conditions in Purchaser's Purchase Order which conflict with the terms and conditions of this instrument shall be disregarded and are hereby rejected, and this instrument shall constitute the entire agreement between Corbin Russwin and the Purchaser.

In the event that Corbin Russwin does not enforce or require strict performance of any term or condition hereof, or of any other document, instrument or other agreement relating to goods sold, such lack of enforcement or requirement of strict performance will not waive, affect or diminish any right of Corbin Russwin to enforce or require strict performance of such term or condition in the future.

PRICES

All prices are subject to change without notice and are not guaranteed. Possession of this price list does not constitute an agreement to sell. We reserve the right to correct any errors at any time.

TERMS

Invoices dated the 1st through the 15th will be due for 2% discount on the *10th of the following month. Invoices dated the 16th through the 31st will be due for 2% discount on the *25th of the following month. *Net immediately thereafter. (Corbin Russwin retains the right to sell or to decline to sell to any Customer for any reason whatsoever when in its judgment is deemed sufficient.)

It is understood that Corbin Russwin may impose and charge a finance charge which is the lesser of one and one-half percent (1-1/2%) per month or the highest rate allowed by law on any amount which becomes past due and delinquent. Additionally the Customer shall be responsible for all collection costs, court costs and reasonable attorney's fees (where allowed by law) in connection with the recovery of any delinquent amount.

FREIGHT

All orders are shipped FOB factory/warehouse, except as expressly provided below. When delivered to the Transportation Company, the Purchaser assumes the risk of loss or damage in transit.

Customer orders with net product value in excess of \$12,000.00 will be shipped prepaid by Corbin Russwin's carrier of choice to a single destination point in the United States.

Customer orders with net product value less than \$12,000.00 will be shipped prepaid by Corbin Russwin's carrier of choice and freight and handling charges will be added to the customer's invoice.

A minimum freight and handling charge of \$15.00 will be charged on orders with net product value of \$400.00 or less. The minimum freight and handling charge will not apply to orders for only Cut (bitted) keys of any type, Master Keys, Master keyed cylinders or padlocks and factory generated bitting lists that do not have any other product types included on the order. Freight on these orders will be charged as the percentage of invoice value.

For orders with net product value greater than \$400.00 and less than \$12,000.00, freight charges will be calculated as a percentage of the net invoice value and will be added to Customer's invoice. The percentage is based on the National U.S. Average On Highway Diesel Fuel Prices as reported by the US Department of Energy in effect at the beginning of each month. The new rate will be published on the Corbin Russwin and Door Security Solutions extranet and will go into effect for shipments beginning on the 1st day of the month. Please refer to the extranet for the rate chart and information on the current freight charge percentage.

Great Grand Master keys, Grand Master keys, Master keys, Construction Master keys, Control Keys, Lot Day Keys which are shipped separate from customer order for security reasons, on orders with total net product value in excess of \$12,000.00 will be shipped prepaid by Corbin Russwin's carrier of choice. If the total order value is less than \$12,000.00, the shipping charges will be added to Customer's invoice.

If a customer provides their own freight account # for the freight charges, Corbin Russwin will apply a handling fee of \$25.00 to the invoice.

Quick Ship Orders – All 1-Week Quick Ship orders are guaranteed to ship from Corbin Russwin 5 working days after receipt of all information necessary to process order or Corbin Russwin will pay freight costs. If Quick Ship is held for credit reasons Corbin Russwin will not be responsible for freight costs.

Expedited shipping options – If the customer requests an expedited method of shipment such as "Next Day Air" the charges will be prepaid by Corbin Russwin and the full rate for the service, as published by the carrier, will be added to the customer's invoice.

Terms and Conditions continued

Packing – Corbin Russwin will pack, mark and ship the products according to its standard procedures for shipment, unless the parties agree, in writing, that Corbin Russwin will comply with any special instructions provided by the customer. Special instructions must be submitted, in writing, at time of order placement. Compliance with special instructions may result in an increased price.

QUOTATIONS

If Corbin Russwin elects to offer a quote, such quote will be valid until the expiration date on that quote.

Only one quote is accepted per purchase order.

Complete shipment of the order must be accepted by Purchaser within standard manufacturing lead times. The quote number must be referenced on the purchase order. Any invoiced order that has the incorrect discount applied to it and did not have the quote number written on the order will have a service fee of \$100.00 net DEDUCTED from any sales credit issued for the difference in discount. The quote is null and void if the Purchase Order does not include ALL product lines listed on the quote or if the quantities for any item covered by the quote deviate by 10% or more. With the issuance and acceptance of a quote for the purchase of products, the Purchaser agrees that products so purchased will not be resold or transferred to any Distributor not authorized by Corbin Russwin to sell its products. This would be inclusive of branches of the quoted Distributor. Failure to abide by this restriction may result in the Distributor's ineligibility for Quotations, or other actions in Corbin Russwin's discretion. Corbin Russwin and its sales representatives reserve the right, in their sole discretion and for any reason, to refuse a Distributor's request to quote a price other than Corbin Russwin's standard list price and regardless of whether Corbin Russwin or its sales representatives have previously quoted discounted prices to the Distributor on some or all of its purchase orders.

NON-CATALOGED PRODUCTS

Products not cataloged or listed in this price book will be considered as special products, and will not be manufactured without prior written approval from Corbin Russwin. A minimum special handling charge of \$50.00 will be added for non-cataloged product. Any additional labor or material required will be charged accordingly. Special products require special handling, and therefore standard lead times may not apply. Please consult with your Sales Representative for further details.

CHANGES/CANCELLATION OF ORDERS

Changes or cancellations to an order will result in a charge of costs for material and labor expenses that have been incurred prior to notification from Customer. If products have already been made and/or are located in the shipping room, the 45% change/cancellation fee will apply. Handling charges are billed on Customer's original order. All Non-Cataloged Goods and Corbin Russwin Quick Ship Orders may not be changed or canceled.

All change requests for goods, other than for the reasons stated above, must be submitted in writing to Customer Service within two (2) business days of receipt of acknowledgment of the order.

PACKAGING

Many items are defined as to Case Lot Packaging or Minimum Order. The Case Lot policy does not apply to hardware to be used on a specific hardware project.

DELIVERY

Orders will be acknowledged and given a scheduled delivery date based on estimated manufacturing lead times. Complete information is required to process all orders. Orders with insufficient information for processing (i.e. keying information, door sizes, handing, etc.) may be subject to extended lead times which are relative to the time required in obtaining the necessary information for order processing. Manufacturing lead time will begin once all information is received to process an order. Corbin Russwin will use reasonable efforts to deliver products as estimated, but makes no guarantees as to delivery dates. Corbin Russwin will not be liable for back charges incurred based on availability of product or as a result of delays in delivery caused by insufficient information required to process an order. Corbin Russwin will not be held responsible for delays in delivery caused by strikes, fires, floods or any other causes beyond our control, including the delivery of material to us. Under no circumstances shall Corbin Russwin be liable or accountable for consequential damages due to failure of delivery.

CLAIMS

In the event of Company or Customer error, claims for shortages, pricing errors and/or incorrectly filled orders must be submitted in writing to Customer Service within thirty (30) days from receipt of material. Any claims for shortages or damage by the Carrier must be made by the Customer directly to the Carrier.

INVOICE DEDUCTION

A Corbin Russwin Sales Representative or Customer Service Representative must be notified of any disputed invoices within sixty (60) days from the date of invoice. Deductions should only be taken for the disputed amount and the balance of the invoice is due and payable within standard payment terms.

Terms and Conditions continued**RETURNED GOODS**

It is the policy of Corbin Russwin to not accept returns of any materials that are correctly furnished as per the Distributor's Purchase Order. Return of product due to customer order error or accommodation must be pre-arranged with Corbin Russwin and approved in writing by Sales Management.

All products returned as "Goodwill" must meet the following criteria to be considered a return:

- Be in original, unmarked and undamaged cartons.
- Be valued in excess of \$250.00 net.
- Shipped and invoiced within the previous one hundred twenty (120) days.
- Custom, non-cataloged goods, master-keyed or Corbin Russwin Quick Ship product is not returnable.

A MINIMUM reprocessing fee of 45% will be charged. Upon receipt and verification by Corbin Russwin that the returned merchandise meets the foregoing conditions, a credit will be issued for the original invoice amount less the MINIMUM 45% reprocessing fee.

Defective goods and "Goodwill" products that meet the foregoing criteria may be returned by fulfilling the following conditions:

- Send an RGA request in writing to the Corbin Russwin Sales Representative serving the Purchaser's area.
- Ensure the RGA labels that are sent to Purchaser by Corbin Russwin are visible on return goods shipment.
- Ensure that the RGA number appears on the return shipment label and is legible.
- Return the authorized merchandise within sixty (60) days from the date of RGA issuance date.
- Return shipments must be freight prepaid to the location specified on the RGA.
- Corbin Russwin is not liable for damages to product during shipping.

No credit may be taken or issued prior to RGA approval and receipt of product.

All defective goods within the terms of our limited warranty may be returned for credit or replacement.

RETURNED GOODS – ELECTROMECHANICAL

All defective replacement requests for electromechanical products/components must be authorized by contacting the Electromechanical Applications Team at 1-800-810-WIRE to obtain a case number. In order to receive credit for the replacement of an electromechanical product the following criteria needs to be met:

- Defective product return must be under warranty
- Defective product/component return must arrive at factory within 60 days of the Returned Goods Authorization issuance
- Returned product must be found defective or nonfunctional upon test at factory
- Returned product must not have been damaged during installation process

TAXES

Prices do not include any present or future Federal, State, or Local property, license, privilege, sales, use, excise, gross receipts or other like taxes or assessments, which may result from transactions or any services performed in connection herewith.

GOVERNING LAW

The rights and obligations of the parties shall be governed by the laws of the State of North Carolina, excluding any conflicts of law provisions. The United Nations Convention on Contracts for the International Sale of Goods shall not apply to this Agreement.

LIMITED WARRANTY

The Terms and Conditions outlined above are subject to Corbin Russwin's Limited Warranty, which is included in this Price List and incorporated herein by reference.

PRODUCT MODIFICATIONS

Corbin Russwin products are not designed or intended for aftermarket modification. The warranty on Corbin Russwin products becomes void if the product is modified in any way, regardless of whether the modification causes or contributes to any alleged defect. Warranty voiding modifications include, but are not limited to, third-party electrification of non-electric products and/or the installation of non-approved or non-Corbin Russwin components.

If a Corbin Russwin product is modified it no longer meets industry certification and quality control standards applicable to the original product and is no longer a genuine Corbin Russwin product. A modified product may not be sold as a Corbin Russwin product and the Corbin Russwin and Design® trademark or certification marks based on the original Corbin Russwin product, such as U.L. or ANSI/BHMA marks, may not appear anywhere on the modified product or on any packaging, literature, or instructions sold with the modified product.

All original Corbin Russwin packaging and literature carries the Corbin Russwin and Design® trademark and must be destroyed if the original Corbin Russwin product is modified. Portions of the product that carry the Corbin Russwin and Design® trademark or certification mark must be discarded and/or replaced by the party making the modification. U.L. and other certification testing and marking are also the responsibility of the party making modification. The use of the Corbin Russwin and Design® trademark on modified products constitutes trademark infringement.

Terms and Conditions continued**DELAYED ORDER NOTIFICATIONS (DON's)**

The orders awaiting a response for a DON will be cancelled if no answer is received from the customer after 5 days.

FIRE RATED OPENINGS

Any retrofit or other field modification to a fire rated opening can potentially impact the fire rating of the opening, and Corbin Russwin, Inc. makes no representations or warranties concerning what such impact may be in any specific situation. When retrofitting any portion of an existing fire-rated opening, or specifying and installing a new fire-rated opening, please consult with a code specialist or local code official (Authority Having Jurisdiction) to ensure compliance with all applicable codes and ratings.

TRADEMARK USE POLICY: ASSA ABLOY AMERICAS

The following policy ("Policy") of ASSA ABLOY Americas ("ASSA ABLOY"), and all of its affiliated group companies (collectively, the "Group Companies"), applies to the use of certain intellectual property of all such Group Companies, including all trademarks, names, logos, product images, and related information (the "ASSA ABLOY Marks").

ASSA ABLOY Marks are proprietary and critical to the success of ASSA ABLOY and the Group Companies, and may only be used in strict compliance with this Policy.

This Policy covers any person or entity reselling any product of any Group Company with the consent of such Group Company (each, an "Approved Reseller"). Each Approved Reseller has a non-exclusive right to use certain of the ASSA ABLOY Marks relating to any of the Group Companies for which it is an Approved Reseller, subject to the following conditions:

- (1) Approved Reseller's use of ASSA ABLOY Marks must be truthful, fair, and not misleading;
- (2) Approved Reseller's advertising must clearly indicate that it is advertising of the Approved Reseller, and is not advertising of ASSA ABLOY;
- (3) Approved Reseller may not use any ASSA ABLOY Marks as part of or in connection with a domain name;
- (4) Approved Reseller's advertising must not imply or suggest an association between the Approved Reseller and ASSA ABLOY other than that of buyer and seller;
- (5) Approved Reseller's use of ASSA ABLOY Marks must be a positive representation of ASSA ABLOY, the Group Companies, and their products;
- (6) Approved Reseller's trade name must be more predominant on Approved Reseller's advertising than the ASSA ABLOY Marks;
- (7) Approved Reseller's use of ASSA ABLOY Marks must include the trademark symbol ® or ™, as appropriate, along with the following trademark legend printed in legible text on the Web page or document containing ASSA ABLOY Marks: "[describe ASSA ABLOY Marks] are trademarks or registered trademarks of ASSA ABLOY, Inc. or one of its affiliates in the United States and other countries.";
- (8) Approved Reseller must not make modifications of any ASSA ABLOY Marks; and
- (9) Approved Reseller may use only ASSA ABLOY Marks associated with the Group Companies for which it is an Approved Reseller (e.g., an Approved Reseller that sells Group Company X products but not Group Company Y products may use Group Company X trademarks in connection with its sale of Group Company X products, but may not use Group Company Y trademarks).

ASSA ABLOY reserves the right to review Approved Reseller's usage of ASSA ABLOY Marks at any time and may:

- (a) require changes to the use of ASSA ABLOY Marks at any time in its sole discretion, which changes must be implemented within 30 days of written notice to Approved Reseller;
- (b) condition the use of ASSA ABLOY Marks on ASSA ABLOY's prior approval of such use, which approval may be withheld in its sole discretion;
- (c) revoke permission to use ASSA ABLOY Marks at any time for any or no reason upon 30 days prior written notice to Approved Reseller; and
- (d) revoke permission to use ASSA ABLOY Marks immediately upon notice to Approved Reseller in the event Approved Reseller is in violation of this Policy, or of any other agreement with ASSA ABLOY or any Group Company.

Approved Reseller's right to use ASSA ABLOY Marks in no way conveys to Approved Reseller any proprietary or economic interest in any ASSA ABLOY Marks.

Use of ASSA ABLOY Marks in violation of this Policy may result in severe civil and criminal liabilities. ASSA ABLOY will vigorously enforce this Policy by seeking all appropriate legal remedies, including, but not limited to, pecuniary damages and injunctive relief.

TECHNICAL INFORMATION AND ADVICE

(a) All designs, data, and specifications provided by Company are proprietary and will not be disclosed or reused by Customer without the prior written consent of Company; (b) Company assumes no obligation or liability for any advice given by Company, the results obtained, or damages incurred, and all such advice is given and accepted at Customer's risk.

Terms and Conditions continued**EXPORT CONTROL AND SANCTIONS:**

The Customer represents and warrants to Corbin Russwin that it will always act in compliance with Economic Sanctions and Export Control Laws, and that:

- a. neither the Customer, its affiliates, or any of their respective directors, officers, employees nor, so far as the Customer is aware, any agents or other persons acting on behalf of any of the foregoing:
 - i. is, or has been, a Listed Person;
 - ii. has engaged in any business dealings or activities that would reasonably be expected to result in it becoming a Listed Person;
 - iii. directly or indirectly, has conducted or is conducting any business dealings or activities with or for the benefit of, or is otherwise involved in any business with a Listed Person, or otherwise acting in violation of Economic Sanctions and Export Control Laws;
 - iv. has engaged or is engaging in any transaction that circumvents, evades or avoids, or has the purpose or effect of circumvention, evading or avoiding, or attempts to violate, any Economic Sanctions and Export Control Laws; or
 - v. is, or has been, in violation of, or subject to, any investigation or enquiry by, or on behalf of, any governmental or other regulatory body relating to Economic Sanctions and Export Control Laws.
- b. the Customer shall act in compliance with Economic Sanctions and Export Control Laws, and shall not sell nor re-export the Product without all requisite licenses and approvals under Economic Sanctions and Export Control Laws;
- c. the Customer shall not sell, export or re-export, the Product, directly or indirectly, to the Russian Federation or Belarus or for use in the Russian Federation or Belarus (whether or not permitted under Economic Sanctions and Export Control Laws applicable to the Customer);
- d. the Customer shall undertake its best efforts to ensure that the purpose of this Clause is not frustrated by any third parties further down the commercial chain, including by possible resellers;
- e. the Customer agrees to (i) cascade the contractual obligations set forth in this Clause. in contracts with third parties, including possible resellers, further down the commercial chain.; and (ii) set up and maintain an adequate monitoring mechanism to detect conduct by any third parties further down the commercial chain, including by possible resellers, that would frustrate the purpose of this Clause;
- f. the representations and warranties set forth in this Clause shall always remain true and correct;
- g. the Customer will provide written notice to Corbin Russwin as promptly as possible and in any event within five business days, if (i) any representation or warranty should cease to be true at any time., or (ii) the Customer should encounter any problems in applying Clauses b)- e), above, including any relevant activities by third parties that could frustrate the purpose of said clause; and
- h. the Customer will not engage in any transaction for Military End-Use unless explicitly approved by Corbin Russwin.
- i. The Customer will provide all information relating to requests for Products, that the Customer suspects could violate or circumvent Economic Sanctions and Export Control Laws, including requests from or on behalf of a Listed Person, and other attempts to acquire Corbin Russwin products in violation of Economic Sanctions and Export Control Laws. The Customer will, to the best of its abilities, cooperate with Corbin Russwin to facilitate compliance with Economic Sanctions and Export Control Laws and will upon Corbin Russwin's request provide Corbin Russwin with true, complete and correct copies of all documentation relating to any business dealings involving the Product, including but not limited to, end-user certifications, information concerning compliance with the obligations under Clause. b)- e), and other information as may be required by Corbin Russwin within two weeks of the simple request of such information.

Corbin Russwin shall not be obliged to make any payment or take any other action if Corbin Russwin believes in good faith that such action may constitute a violation, contribute to a violation, or constitute a circumvention of any Economic Sanctions and Export Control Laws.

COMPLIANCE WITH ANTI-TRUST, ANTI-CORRUPTION AND DATA PRIVACY LAWS:

The Customer, its directors, officers, and employees shall perform their obligations under these Terms and Conditions in full compliance with the ASSA ABLOY Code of Conduct which is accessible online at: [CoC Business partner 2019 English.pdf](#)

Limited Warranty

Corbin Russwin, Inc. (Company) warrants that its products sold under the Corbin Russwin and Design® trade name in the United States of America are free from defects in workmanship and materials under normal use and service. This warranty does not cover defects or damage arising from improper installation, lack of or improper maintenance, improper storage, shipping and handling, corrosion, erosion, ordinary wear and tear, misuse, abuse, accident, unauthorized service, or use with unauthorized non-Corbin Russwin products or parts. This warranty is void if any modification is made to the warranty product, regardless of whether the modification causes or contributes to the alleged defect. All modifications are made at the risk of the party making the modification.

The only liability of the Company in tort or contract whether under this warranty or otherwise shall be limited to the repair or replacement of any product or component part which shall prove defective as covered by this warranty, within the stated time frame listed below, after delivery to the original purchaser.

DC6200 & DC6400 Series Door Closers	30 years
DC8000 Series Door Closers	30 years
DC3200 Series Door Closers	15 years
DC5200 Door Closers.....	30 years
ML2000 Series Mortise Locksets.....	10 years
CL3100 Series Cylindrical Locksets	10 years
CLX3300 Series Cylindrical Locksets	10 years
CL3300/CL3500/CL3800 Series Cylindrical Locksets	7 years
FE5400S/FE6700/FE6800/MP6600/BL6600 Series Multi-point Locksets	7 years
ED4000, ED5000 Series Exit Devices, MELR Option & 900 Series Trim	5 years
MP9800 Series	5 years
Pyramid Cylinders.....	5 years
CK4300 Series Cylindrical Knob Locksets.....	3 years
All Electro-mechanical and electronic products.....	2 years
Electrified Exit Devices.....	2 years
Access 3 Cylinders.....	1 year
All Other Locksets	1 year
All Other Exit Device Trim.....	1 year
All Other Corbin Russwin Products.....	1 year
ED3000, ED7000, ED8000 Series Exit Devices & Trim.....	1 year
MicroShield® Finish	1 year

Notes:

• **DC6000, DC8000 Closers:**

- Manufactured after May 1, 2021 30 years
- Manufactured from August 2012 until April 2021 25 years
- Manufactured prior to August 2012 10 years

• **DC5200 Closers:**

- Manufactured after November 1, 2023..... 30 years
- DC5230, DC5240 closers manufactured prior to this November 1, 2023 10 years

Finishes:

Corbin Russwin finishes are covered by a limited warranty period of one year after invoice date.

Warranty Requirements for Cylinders Factory or Field Combined:

Cylinders are lubricated at the factory with a petroleum based lubricant (Moist-Out / MO-10). Cylinders should be lubricated periodically depending upon environmental conditions. FLUID FILM lubricant is recommended. Never mix petroleum based lubricants with dry lubricants. Corbin Russwin cylinder and/or core warranty will be voided if used in non-Corbin Russwin locking devices.

Continued on next page

Limited Warranty continued**Warranty Requirements for Cylinders Field Combined:**

1. Keys shall be cut to the Corbin Russwin key biting specifications required for the particular keyway and depth system.
2. All pin lengths shall be selected according to prevailing factory standards.
3. Original Corbin Russwin cylinders and cylinder components, including pin tumblers and key blanks, shall be used. We reserve the right to void the warranty if we deem that a malfunction is a result of non-original components which do not conform to Corbin Russwin standards.

Keying Systems:

All bittings shall be originated or authorized by the Corbin Russwin Key Systems Department to be compatible with one another in a specific type of cylinder (Access 3, Pyramid, conventional, security, master ring, interchangeable core) and within a particular keying system. Product repair or replacement, or associated charges, will not be accepted under this warranty unless prior authorization from Corbin Russwin has been given. Upon receipt of products returned for repair or replacement, we will determine whether products qualify for repair or replacement under this warranty. If they do not, we will obtain authorization prior to proceeding. We have no liability to pay any costs of repair performed by anyone other than qualified personnel authorized by Corbin Russwin prior to the work being done.

The Company will not pay for the cost of repair performed other than in accordance with this warranty. Written notice of a product or component part believed to be defective as covered by this warranty should be sent to Corbin Russwin, Inc. 225 Episcopal Road, Berlin, CT 06037, and should include your name and address, an identification of the product or component part and a brief description of the defect. Upon receipt of such notice, the Company will inform you where to ship such product or component part, shipping charges prepaid, for examination and, in the event such examination reveals defect covered by this warranty, the product will be repaired or replaced. The Company reserves the right to replace discontinued product with an equivalent product as deemed by the Company.

THIS WARRANTY IS IN LIEU OF ALL OTHER EXPRESS WARRANTIES. TO THE EXTENT PERMITTED BY LAW, ALL IMPLIED WARRANTIES ARE LIMITED TO THE DURATION OF THIS WARRANTY. CORBIN RUSSWIN, INC. SHALL NOT BE LIABLE FOR ANY INCIDENTAL OR CONSEQUENTIAL DAMAGES. NO AGENT, SALES REPRESENTATIVE OR DEALER HAS THE AUTHORITY TO INCREASE OR ALTER THE OBLIGATIONS OF THIS WARRANTY. SOME STATES DO NOT ALLOW LIMITATIONS ON HOW LONG AN IMPLIED WARRANTY LASTS OR THE EXCLUSION OR LIMITATION OF INCIDENTAL OR CONSEQUENTIAL DAMAGES, SO THE ABOVE LIMITATION OR EXCLUSIONS MAY NOT APPLY TO YOU. THIS WARRANTY GIVES YOU SPECIFIC LEGAL RIGHTS, AND YOU MAY ALSO HAVE OTHER RIGHTS WHICH VARY FROM STATE TO STATE.

Cylinder Service Fee**Cylinders for Competitor Products:**

Corbin Russwin cylinders or cores for use in non-Corbin Russwin manufactured locking devices for which Corbin Russwin has an equivalent, will be assessed a Cylinder Service Fee of \$100.00 (net) per Cylinder. This fee applies to master keyed cylinder only orders, 1 bitted high security cylinders and zero or 1 bitted restricted cylinder orders.

Finishes

ANSI/BHMA Designation	Finish/Description
600	Primed for Painting (USP)
605	Bright Brass (US3)
606	Satin Brass (US4)
611	Bright Bronze (US9)
612	Satin Bronze (US10)
613	Dark Oxidized Satin Bronze, Oil Rubbed (US10B)
613E	Dark Oxidized Satin Bronze - Equivalent
613L	Dark Oxidized Satin Bronze, Clear Coated
618	Bright Nickel Plated (US14)
619	Satin Nickel Plated (US15)
622	Flat Black Coated (US19)
625	Bright Chromium Plated (US26)
626	Satin Chromium Plated (US26D)
628	Satin Aluminum, Clear Anodized (808 Mullion)
629*	Bright Stainless Steel (US32)
630*	Satin Stainless Steel (US32D)
689	Silver Aluminum Painted (SBL)
690	Dark Bronze Painted (DBL)
691	Light Bronze Painted (LBL)
693	Black Painted (FBL)
695	Dark Bronze Painted or Anodized (808 Mullion)
696	Satin Brass Painted (GBL)
722	Black oxidized bronze, oil rubbed
BSP	Black Suede Powder Coat
WSP	White Suede Powder Coat

*629 and 630 finish options are Not available for the following Muséo levers: 104, 105, 111, 112, 114, 115, 116, 117, 119, 121, 126, 131

Samples

Display Mounts (Base Hardware not included). Price covers mount only.

For Product Series	Specify	Price
CL3100, CK4800	SM-CL-NTB	\$195.00
CLX3300, CL3800	SM-CL-TB	\$195.00
ML2000 x Sectional Trim (Lever, Knob, BLSS, HSS, HPSK)	SM-ML-L	\$182.00
ML2000 x BHSS trim	SM-ML-WAVE-CYL x TP	\$286.00

Finish folder with cylinder scalps.

Specify	Price
FP	\$176.00

Corbin Russwin Templates

Templates of Corbin Russwin products that are most commonly used are available through our website <http://www.corbinrusswin.com/en/site/corbin-russwin/Library/Product-Templates/>

General Information:

Standard Features: Keying, Keys, Pins	24
Keyway Availability	25
General Information	26
Policy	27
Construction Core Program	28
Keying, Stamping, Cut Keys	29
Bitting List	30
Key Wizard	31

Key Blanks:

Stamping, Standard, Pyramid, Access 3	32
Security Bow, Large Bow, Emergency Blanks, Emergency Master Key	33

Access 3 AP Security Cylinders

AP Fixed Core (Mortise/Rim), AP LFIC (Mortise/Rim)	34
AP LFIC, Fixed Core Component Cylinder, Deadlock Cylinder	35
AS Fixed Core (Mortise/Rim), AS LFIC (Mortise/Rim)	36
AS LFIC Core, AS Fixed Core Component Cylinder, AS Fixed Core Deadlock Cylinder	37
AHS Fixed Core (Mortise/Rim), AHS LFIC (Mortise/Rim)	38
AHS LFIC Core, AHS Fixed Core, Deadlock Cylinder, UL LFIC 6-Pin Housing (Mortise/Rim)	39

Pyramid Cylinders:

Fixed Core (Mortise/Rim)	40
Key-In-Lever/Knob High Security UL437 Listed	41
Interchangeable Core (Mortise/Rim)	42
Fixed Core (Mortise/Rim)	43
Key-In-Lever/Knob	44
Interchangeable Core (Mortise/Rim)	45

Conventional Cylinders:

Standard Mortise	46
Flexible Head Mortise, Concealed Shell Mortise	47
Special Function Mortise, Hotel Function Mortise	48
Non-Keyed Mortise, Thumbturn, Dummy, Rim Thumbturn Cylinders	49
Rim (.552 diameter Plug)	50
Key-In-Lever/Knob (.509 Plug), DL2200, DL3200 Series Cylindrical Deadlock	51
Key-In-Lever/Knob UT5200, CK4200, CK4400, G10, PL5000	52
Key-In-Lever/Knob (.552 dia Plug), Adams Rite 4025 Pull	53

Interchangeable Core Cylinders:

IC Mortise, Hotel Function IC Mortise	54
IC Rim, Core Only	55
SFIC Mortise, SFIC Rim	56
SFIC Rim, SFIC Core Only	57
LFIC Mortise Housing Only, LFIC Rim Housing Only	58
SFIC Mortise Housing Only, SFIC Rim Housing Only	59

Security Cylinders:

Standard Security Mortise	60
Special Function Security Mortise, Hotel	61
Security Rim	62
Security Key-In-Lever/Knob (.552 Plug)	63
Security Interchangeable Cylinders: IC Mortise, Hotel Function	64
Security Interchangeable Cylinders: IC Rim, Security Core	65

Master Ring Cylinders:

Standard Master Ring Cylinder	66
Flexible Head Master Ring Mortise	67
Master Ring Rim, CK4200 & UT5200 Series, Special Applications	68
Service Equipment	69
Blank Page	70

**Standard Features
Keying**

0-bitted except high security; random keying option offered at no charge

Keys

Two nickel silver keys

Pins

5-pin for 252, 752, 852 and A Class; all others furnished 6-pin

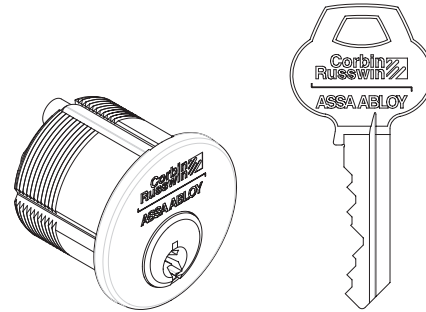

Ordering Examples

Stock Order - Conventional Cylinder

Quantity	Cylinder	Finish
25	CR1000	626

Contract/Detailed Order - Conventional Cylinder

Quantity	Keyset	Cylinder	Finish	Option
25	AA1	CR1000-138-A02-7	626	CKC2

Stock Order - IC Cylinder

Quantity	Cylinder	Finish
20	CR1080	626

Contract/Detailed Order - IC Cylinder

Quantity	Keyset	Cylinder	Finish	Misc.Option
4	AF3	CR1080-112-A04-7	606	CKC2

Keyway Availability

Corbin Russwin keyways are separated into categories known as **Key Classes**, based on blade width and bitting dimensions. **Certain key blanks and cylinders are not available for certain key classes**, and notes to that effect appear in the catalog and price book. If you find a keyway exclusion notice and do not know the class of the keyway you need, refer to the list below.

Some keyways listed here are *inactive*. They remain available to support existing systems, but no *new systems* are generated on them.

Keyway	Remarks
26	Discontinued
27 Series	X Class (28 and 29 are inactive)
57 Series	X Class
59 Series	Z Class
60	Z Class
67 Series	X Class (68 and 69 are inactive)
70	Z Class
77 Series	X Class (77 and 78 are inactive)
97 and 99	X Class
252	852 Class (inactive)
752	752 Class (inactive)
852	852 Class (inactive)
981, 982, 983	981 Class (inactive)
A1 thru A24	A Class (inactive)
Access 3	Access 3
AR, BR, BL	X Class
D1 thru D4	DH Class
G	852 Class (inactive)
H1 thru H8	DH Class
L1 thru L4	Z Class (L2 formerly CCL)
N1 thru N28	N Class (inactive)
Pyramid	Pyramid
Protected	DH or Z Class
Restricted	DH or Z Class
Best	Best keyways for SFIC

Keyway Name Changes

All Multiplex Keyways using letters with numbers are now standardized to have the letter first and number last. Also, keyway designation will no longer include the number of pins. K and Z designations are being replaced by the more common N and A Series, respectively. 960 and 970 Series are replaced by the more common 980 Series. Only the following Russwin® older keyways are affected:

Old Designation	Pins	New Designation
1N thru 28N	6	N1 thru N28
1K thru 28K	5 or 7	N1 thru N28
1A thru 24A	5	A1 thru A24
1Z thru 24Z	6	A1 thru A24
961, 962, 963	6	981, 982, 983
971, 972, 973	7	981, 982, 983

Category	Description	Price
Stock L4	Keyway used for stock orders and limited keying systems.	No Charge
Standard (see list at left)	Keyways in general use for keying systems.	No Charge
Restricted (not published)	Selective keyways for use in new and existing keying systems.	No Charge
Protected	Notice of Acceptance showing facilities name, address and contact information must be submitted to key records before orders can be processed. Key system administration approval required prior to processing of order.	No Charge
Pyramid	One of Corbin Russwin's line of high security cylinders	See Pyramid pages 40-45
Security	Old Emhart®/Security cylinders.	For existing systems only
Access 3	Corbin Russwin's highest level of key control.	See Access 3 pages 34-39

Key Systems Security Policy

The purpose of this security policy is to enforce our policies Access 3, Pyramid, Security, Protected & Restricted keyway product, including key system information.

No master key system information or security related product is to be given or sold to anyone other than the facility owner through written correspondence. Verification must be submitted (fax copy will be acceptable) to Key Systems Administration. The verification must be on the facility's letterhead and signed by a facility authorized systems administrator. Key Systems Administration does not maintain "Letters of Authorization" on file. Each order must be accompanied by proper authorization. Only after the authorization has been verified will the order be processed for production.

Also includes:

- Bitting information (even one bitting, absolutely no top-level master keys)
- Bitting lists (all formats; i.e., hard copy, disc)
- Key blanks and systems components for Access 3 AS/AHS, Pyramid, and security cylinder systems.

Please note:

- No orders are to be processed through Key Systems Administration without proper authorization.
- Only orders with appropriate authorization attached will be given priority.
- Requests for systems information without proper authorization from the owner will be denied.
- Requests for information regarding the purchase of any systems support products as listed above will be referred to the local authorized sales agency.
- Refer to the current price lists for additional policies and procedures as they relate to this security policy.

Remember:

The purpose for the establishment of any security system is to provide an increased level of protection for the Facility owner.

Construction Core Program

How To Order

Use Quick Code CT6 for 6-PIN LFIC, CT7 for 7-PIN LFIC, CT6SB for 6-PIN SFIC, CT7SB for 7-PIN SFIC, and CTP for Access 3, Pyramid IC products. Use a separate purchase order or line item to order the permanent systems' core.

Cut Keys

Specify the required number of change keys and control keys on the order. Two control keys are provided at no charge. Two change keys are provided at no charge for the first 20 units ordered. One additional change key is provided for every 10 additional units at no charge.

Examples: 25 units provide 2 operating keys; 30 units provide 3; 100 units provide 10. Additional keys will be invoiced at the prevailing cut key price.

How To Return Cores

Contact your Customer Service Representative for a Returned Goods Authorization. Provide the factory order number and year of the original order. Credit is issued for all cores returned in good operating condition, based on the price of a standard 6- or 7-pin core at the time of the original order. Applicable discounts to the original unit are applied to the returned core.

Current pricing is as follows:	Price
6-PIN CONSTRUCTION CORE: (e.g. CR8000-CT6) returned for credit	\$112.00
7-PIN CONSTRUCTION CORE: (e.g. CR8000-CT7) returned for credit	\$114.00

How To Price

Use Quick Code charts in lockset and exit device price sections.

1 ea. Lockset	ML2051 NSA 626	\$1,461.00	List Price
x Construction Core	CTP	\$112.00	List Price
		\$1,573.00	Subtotal
	Less 50/25% discount	\$589.88	Subtotal Net Price
1 ea. Pyramid Permanent Core	CR8027 x 626	\$196.00	List Price
	Less 50% discount	\$98.00	Net Price
		\$687.88	Subtotal Net Price
Return Construction Core	CR8000 Construction Core	\$112.00	List Price
	Less 50/25% discount	\$42.00	(Credit - RGA from factory)
		\$645.88	Your Total Cost

Keying		
Description	Specify Quick Code	Add or Deduct
Cylinder Service Fee (applies to cylinders & cores not being installed in ASSA ABLOY products)		\$100.00 (net)/cyl
Keyed random ³	KR	No Charge
Masterkey Service Fee. Applies to cylinders not being installed in Assa Abloy products		Consult Factory
Master keyed (all cylinders except CR8000, CR8020, CR8200, CR8027, CR8500, CR8600, CR8700 IC Cores)	specify keyset	Add \$16.00 per cylinder
Master keyed Pyramid (except CR8020, CR8027 IC Core)	specify keyset	Add \$16.00 per cylinder
Master keyed Access 3 (except CR8500, CR8600, CR8700 IC Core)	specify keyset	Add \$16.00 per cylinder
Master keyed Security (including IC cylinder and core)	specify keyset	Add \$16.00 per cylinder
Master keyed (CR8000, CR8020, CR8027, CR8200, CR8500, CR8600, CR8700 IC Cores)	specify keyset	No Charge
Master keyed to customer bittings or sample key	specify keyset	Add \$16.00 per cylinder
Construction master keyed ^{1,2}	CMK	Add \$16.00 per cylinder
Temporary Construction core, 6-pin LFIC (Red, Blue or Green) including Access 3 AP & AS	CT6R, CT6B, CT6G	No Charge
Temporary Construction core, 7-pin LFIC (Red, Blue or Green)	CT7R, CT7B, CT7G	No Charge
Temporary Construction core, 6-pin SFIC (Blue)	CT6SB	No Charge
Temporary Construction core, 7-pin SFIC (Blue)	CT7SB	No Charge
Temporary Construction core, 6-pin (Red, Blue or Green) Access 3 AHS	CT6AHR, CT6AHB, CT6AHG	No Charge
Temporary Construction core, Access 3 Pyramid	CTP	No Charge
Temporary Disposable core ⁶	CT6D, CT7D, CTPD	Deduct \$112.00 per cylinder
Small Format Temporary Disposable Cores ⁶	CTSD	Deduct \$101.00 per cylinder
Uncombined (Access 3, Pyramid, Security fixed and IC core) ⁷	UC	Deduct \$8.00
Uncombined (conventional CR8000 IC core) ⁷	UC	Deduct \$2.00
Bump-Resistant Cylinder	BRP	Add \$33.00 per cylinder
More than 2 keys per lock	KY# (e.g., KY6)	See Cut Keys Section Below
For keys packed separately (Indicate appropriate "ship to" address on keying cover sheet)		Add \$4.00 per cylinder

Stamping		
DO NOT DUPLICATE	Order by number	See pages 32-33
End user custom die stamps** for key bows		\$4.00
Other stamping on keyset/cylinders (Up to 7 characters on cylinders)		\$3.00 per character

**For development of custom key stamp add one-time charge of \$840.00. Die is property of Corbin Russwin.

VISUAL CYLINDER/KEY CONTROL:

Description	Cylinders		Keys	
	Stamping	List Price	Stamping	List Price
VKC0 – No stamping except keyway designation (keys will be tagged)	No Stamping	No Charge	No Stamping	\$5/key
VKC1 – Keys only	N/A	N/A	Keyset	No Charge
VKC2 – Cylinder and keys*	Keyset	\$4/cyl	Keyset	No Charge
VKC3 – Cylinder*	Keyset	\$4/cyl	Bittings	No Charge
All VKC, VDC, or VAC stamping codes that use an alternate symbol	Alternate Stamping	\$4/cyl	Alternate Stamping	\$4/cyl

CONCEALED CYLINDER/VISUAL KEY CONTROL:

Description	Cylinders		Keys	
	Stamping	List Price	Stamping	List Price
CKC2 – Cylinder and Keys*	Keyset	\$4/cyl	Keyset	No Charge
CKC3 – Cylinders only*	Keyset	\$4/cyl	Bittings	No Charge
All CKC, CDC, or CAC stamping codes that use an alternate symbol	Alternate Stamping	\$4/cyl	Alternate Stamping	\$4/cyl

*Cylinder face stamping not available for Access 3, Pyramid, or Security products

Cut Keys

Description	Conventional Keyway ⁵ Restricted Keyway		Protected Keyway		SFIC K eys KB42 or KB43	Security Keys KB90 or KB92	Pyramid Keys KB28	Access 3		
	10 Series Bow	50 Series Bow	10 Series Bow	50 Series Bow				AP	AS	AHS
Extra cut change keys with lockset/cylinder	\$7.40	\$8.00	\$8.60	\$9.10	\$12.10	\$27.40	\$14.50	\$7.30	\$14.50	\$14.50
Cut change keys without lockset/cylinder	\$15.40	\$16.00	\$16.60	\$17.10	\$12.10	\$27.40	\$21.00	\$15.40	\$22.60	\$22.60
Cut master keys (all levels) and control keys with or without lockset/cylinder	\$15.40	\$16.00	\$16.60	\$17.10	\$12.10	\$27.40	\$21.00	\$15.40	\$22.60	\$22.60
Cut construction master keys with or without lockset/cylinder	\$15.40	\$16.00	\$16.60	\$17.10	N/A	N/A	N/A	\$15.40	\$22.60	N/A

Cut Change/Control keys for temporary cores with or without lockset/cylinder (Conventional Keyway 10 series only & SFIC KB42 only carry pricing. All other N/A)

Note: Two (2) cut change keys are provided per lockset or cylinder at no charge. Keyblanks cannot be substituted for cut keys.

For keys with bows other than 10 and 90, specify "KB" + number as Quick Code, e.g. KB12. KB92 cannot be furnished with VKC or other markings. Cylinders pinned directly to GMK or MK level keys do not include cut keys. Please order GMK and MK keys separately.

Notes: 1. CMK Construction master keying charge is in addition to master keying charge.

2. CMK Construction master keying is not available in interchangeable core, Access 3 LFIC and hotel function, Pyramid, or Security series.

3. Access 3 and Pyramid series is not available keyed random or 0-bitted. All LFIC and SFIC cylinders unavailable keyed random.

4. Conventional cut change keys are furnished standard with key section, system type and biting number.

5. Disposable cores ordered separately - \$60.00 per set. Sold in multiples of 10 sets.

6. Keys, springs, and spring covers not included.

Presentation Keys		Price
Specify:	Key Symbol; Plating (nickel is standard); Stamping; Bow, if available for key class	
Standard Bow:	51 for all except below	
	90 for Security series	Nickel Plated \$152.00
	10 for 6 PIN 852 & A Class keys	Gold Plated \$291.00

Bitting Lists

To protect the security of keying systems, bitting lists will only be sent to the end user or his designated agent, via Certified Mail Return Receipt Requested or UPS AOD. Copies will not be transmitted via fax. The complete name and address where the bitting list is to be sent must be indicated on the letter of authorization and on the purchase order.

Master key system bitting lists will not be created by Corbin Russwin Key Systems Administration unless the request is accompanied by an order for factory keyed product. Corbin Russwin releases all liabilities for cylinders not pinned to factory master key systems.

# Bittings	Paper	Disc	Simple K	Key Wizard	Paper Price	Disc Price	Simple K/ Key Wizard Price
1-50	KC1-CR	KCD1-CR	DLSK1-CR	DLKW1-CR	\$469.00	\$307.00	\$388.00
51-200	KC2-CR	KCD2-CR	DLSK2-CR	DLKW2-CR	\$631.00	\$469.00	\$550.00
201-1000	KC3-CR	KCD3-CR	DLSK3-CR	DLKW3-CR	\$791.00	\$629.00	\$710.00
1001-3000	KC4-CR	KCD4-CR	DLSK4-CR	DLKW4-CR	\$955.00	\$792.00	\$874.00
3001-6000*	KC5-CR	KCD5-CR	DLSK5-CR	DLKW5-CR	\$1,082.00	\$919.00	\$1,000.00
6001-9000*	KC6-CR	KCD6-CR	DLSK6-CR	DLKW6-CR	\$1,540.00	\$1,378.00	\$1,459.00
Over 9000*	KC7-CR	KCD7-CR	DLSK7-CR	DLKW7-CR	Consult Factory		

NOTE: Bitting Lists requested for keysets ordered with factory keyed product for either a new or existing system will be provided at no charge, except for Simple K DLSK1-CR thru DLSK7-CR & Key Wizard DLKW1-CR thru DLKW7-CR. For existing system pricing above will apply. For new system see page 31

- Additional Bittings or P.O.'s for Bitting Lists Only – **EXISTING MASTER KEY GROUPS**
Up to 10 **total** for keysets tied to **existing** master key groups will be provided at no charge
11 or more bittings will be charged per above chart
- Additional Bittings or P.O.'s for Bitting Lists Only – **NEW MASTER KEY GROUPS**
Regardless of the quantity being requested, will be charged per above chart

These prices are for a hierarchical Master Key system with no cross-keying of selected keys.
For special requirements or for systems prior to 1999, consult Key Systems Administration for a quote.

Corbin Russwin releases all liabilities for cylinders not pinned to factory master key systems.

Cylinders for Competitor Products:

CORBIN RUSSWIN cylinders or cores for use in non-CORBIN RUSSWIN manufactured locking devices for which CORBIN RUSSWIN has an equivalent, will be assessed an additional Cylinder Service Fee. This fee applies to masterkeyed cylinder only orders, 1 bitted high security cylinders and zero or 1 bitted restricted cylinder orders.

Key Management Software

Simple K – Special online ordering procedures accessible via the ASSA ABLOY Door Security Solutions Extranet (www.assaabloydss.com)
- contact customer service for more information.

SimpleK – Standard Edition	Description	Price
SMK040-30	Primary License (3 users)	\$3,286.00
SMK040-31	Updates & Support Plan on Primary License, 1 year	\$615.00
SimpleK – Professional Edition	Description	Price
SMK042-30	Primary License (3 users)	\$4,383.00
SMK042-32	Additional license	\$579.00
SMK042-35	Updates & Support Plan on Primary License, 1 year	\$956.00
SMK042-33	Updates & Support Plan on Additional License, 1 year (per Add. Lic.)	\$159.00
Add-On Modules	Description	Price
SMK032-31	Item Tracking	\$1,387.00
SMK032-33	Web Interface	\$1,827.00
SMK032-35	Room Management	\$877.00
SMK032-37	Mobile Applications	\$1,242.00

Key Systems Administration

Price

Customer Provided Bittings (CPB) 1,2,3,4,5

Add \$16.00 per cylinder

Notes:

1. This charge is for keying to customer supplied bittings only.
2. All cylinders requested to be keyed to combinations not supplied by Corbin Russwin will be subject to this charge.
3. Corbin Russwin releases all liabilities, including key interchange, to systems generated by customer-supplied bittings that are supplied by others.
4. Purchase orders with customer-supplied bittings not meeting Corbin Russwin's specifications will be processed 0-bitted in the specified keyway and exempt from upcharge.
5. Master keying or CMK charges not included.

Disclaimer

Corbin Russwin reserves the right to release total liability of any factory generated master key system which incorporates cross keying, both controlled and uncontrolled. A master key system incorporating cross keying yields less security and jeopardizes system expansion.

Controlled Cross Keying: A condition in which two or more different keys of the same level of keying and under the same higher level

Cross Keying

No Charge

key(s) operate one cylinder by design; e.g., XAA1 operated by AA2.

Uncontrolled Cross Keying: A condition in which two or more different keys under different higher-level keys operate one cylinder by design; e.g., XAA1 operated by AB, AB1.

Stamping Key Section on Key Blanks

Key blanks are furnished standard with no key section ID. When so specified, key blanks can be stamped with the key section at no charge. The minimum quantity for this service is a box of 50 key blanks

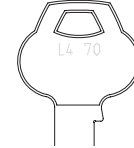

Standard Bow, Nickel Silver (Order in multiples of 50)



Coined Logo	Plain Both Sides	DO NOT DUPLICATE	US PROPERTY DO NOT DUPLICATE	RESTRICTED DO NOT DUPLICATE	Price Each		
					Standard Single Section	Restricted Single Section	Standard and Restricted Multi-Section**
(X1, Z1, R)*	(X4, Z4, P)*	(X5, Z5, P5)*	(X6, Z6, P6)*				
xx-5PIN-10	xx-5PIN-11	xx-5PIN-12	xx-5PIN-13	xx-5PIN-12	\$3.10	\$3.28	\$3.46
xx-6PIN-10	xx-6PIN-11	xx-6PIN-12	xx-6PIN-13	xx-6PIN-12			
xx-7PIN-10	xx-7PIN-11	xx-7PIN-12	xx-7PIN-13	xx-7PIN-12	\$3.19	\$3.37	\$3.49

*(Old Reference)

**Multi-section keys enter more than one keyway; eg. D12, H41, 2852, 9812, 59A, 57AD, 067, etc.

† Protected keyway keys will be stamped "Restricted"

Pyramid (Available in quantities of 10, 25, 50 and multiples of 50)

Standard bow furnished for all Pyramid Keys.



Key Blank Number	Description	Price Each
XX-7PIN-28	Single section	\$10.50
	Multi-section	\$19.60

Access 3



Key Blank Number	Description	Price Each
6PIN-38-AP	Standard key blanks for AP cylinders	\$5.40
6PIN-38-AS	Standard key blanks for AS & AHS cylinders	\$10.50

Security Bow No other shape for security keys. (Order in multiples of 50)

Not Available for 252, 752, 852, A, N, or X Class keys.

Inactive, for existing systems only.



Coined Logo	Plain Both Sides	DO NOT DUPLICATE	US PROPERTY DO NOT DUPLICATE	RESTRICTED DO NOT DUPLICATE	Price Each
xx-6PIN-90	xx-6PIN-91	xx-6PIN-92	xx-6PIN-93	xx-6PIN-92	\$10.50
xx-7PIN-90 for hotel EMK					\$13.20

Large Bows (Order in multiples of 50)

Large Not Available for 252, 752, 852 or A Class keys.



Plain Both Sides	DO NOT DUPLICATE	US PROPERTY DO NOT DUPLICATE	RESTRICTED DO NOT DUPLICATE	Price Each	PROTECTED DO NOT DUPLICATE	Price Each
(Y4 and S)	(Y5 and S5)	(Y6 and S6)				
xx-5PIN-51	xx-5PIN-52	xx-5PIN-53	xx-5PIN-52	\$5.00	xx-5PIN-52	\$7.40
xx-6PIN-51	xx-6PIN-52	xx-6PIN-53	xx-6PIN-52		xx-6PIN-52	
xx-7PIN-51	xx-7PIN-52	xx-7PIN-53	xx-7PIN-52		xx-7PIN-52	

SFIC Key Blanks

Description	Key Number	Price Each
Duplication Prohibited 6-Pin Key	6PIN-42-KB	\$3.80
Duplication Prohibited 7-Pin Key	7PIN-42-KB	\$3.80
US Property Do Not Duplicate 6-Pin Key	6PIN-43-KB	\$3.80
US Property Do Not Duplicate 7-Pin Key	7PIN-43-KB	\$3.80

Emergency Key Blanks for Hotel Function Access 3 Cylinder

Description	Key Number	Price Each
Emergency key for mortise AP cylinders	6PIN-38-E2-AP	\$7.60
Emergency key for mortise AS & AHS cylinders	6PIN-38-E2-AS	\$10.80
Emergency key for key-in lever AP cylinders	6PIN-38-E6-AP	\$7.60
Emergency key for key-in lever AS & AHS cylinders	6PIN-38-E2-AS	\$10.80

Emergency Master Key Blanks for Hotel Function Cylinder (Order in multiples of 10)

Non-IC mortise cylinder use 7PIN blanks, as already listed: xx-7PIN-51 & xx-7PIN-90. (Order in multiples of 50)

Not Available for 252, 752, 852 or A Class keys.



Lockset	EMK Blank	Price Each
IC Mortise	xx-6PIN-51-E1	\$7.60
IC Mortise, Security	xx-6PIN-90-E1	\$10.30
CK4229, including IC; CK4429	xx-6PIN-51-E4	\$7.60
CK4229 Security, Including IC	xx-6PIN-90-E4	\$10.30
CL3329, CL3429, CL3629 6PIN, Including IC	xx-6PIN-51-E8	\$7.60
CL3329, CL3429, CL3629 7PIN, Including IC	xx-7PIN-51-E8	\$7.60
1400/4300 and 5600/3300 Series	xx-6PIN-51-E5	\$8.80

Mortise Cylinder

Cylinder Number	Description	605, 606, 611, 612, 613, 613E, 618, 619, 622, 625, 626, 629, 630, 722, BSP, WSP
CR1500-114	ML2000 Series mortise locks (including electrified and EAC devices)	\$130.00
CR1500-138	DL3000 and DL4100 deadlocks	
CR1500-112	ED5600, ED6600 and ED7600 exit devices	
CR1500-134	All ED5000 cylinder dogging, alarm units, delayed egress cylinders	
CR1501-114-A01	AP Hotel Mortise Cylinder	\$175.00

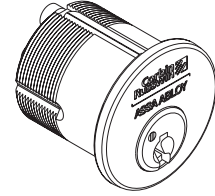

Rim Cylinder

Cylinder Number	Description	605, 606, 611, 612, 613, 613E, 618, 619, 622, 625, 626, 629, 630, 722, BSP, WSP
CR3500-058	5/8" tailpiece	\$130.00
CR3500-138	1-3/8" M61 & M62 option for ED8200 and obsolete ED9200 exit device alarms; ED5202(A) inside cylinder	
CR3500-200	2" tailpiece	
CR3500-200N	2" ED4000/ED5000 night latch function	
CR3500-200V	2" vertical tailpiece	\$132.00
CR3500-312	3-1/2" tailpiece	
CR3500-312V	3-1/2" vertical tailpiece	

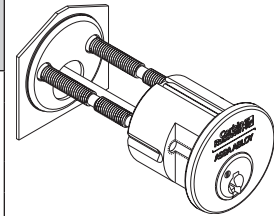

AP LFIC - Mortise Cylinder

Cylinder Number	Description	605, 606, 611, 612, 613, 613E, 618, 619, 622, 625, 626, 629, 630, 722, BSP, WSP
CR1580-114	ML2000 Series mortise locks (including electrified and EAC devices)	\$242.00
CR1580-138	DL3000 and DL4100 deadlocks	\$245.00
CR1580-112	ED5600, ED6600 and ED7600 exit devices	
CR1580-134	All ED5000 cylinder dogging, alarm units, delayed egress cylinders	\$253.00

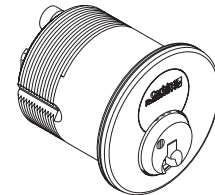

AP LFIC - Rim Cylinder

Cylinder Number	Description	605, 606, 611, 612, 613, 613E, 618, 619, 622, 625, 626, 629, 630, 722, BSP, WSP
CR3580-058	5/8" tailpiece	\$242.00
CR3580-114	1-1/4" M61 & M62 option for ED8200 and ED9200 exit device alarms	
CR3580-178	1-7/8" tailpiece	
CR3580-178V	1-7/8" vertical tailpiece	
CR3580-318	3-1/8" tailpiece	\$244.00

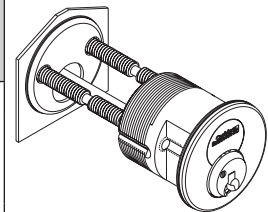

*LFIC Cores are provided in 606, 626 or BSP finish only.

AP LFIC Core

Cylinder Number	Description	Finish: 606, 626, BSP
CR8500	All Corbin Russwin LFIC cylinders	\$112.00

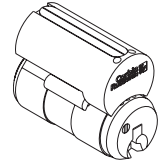

AP Fixed Core Component Cylinder

Cylinder Number	Description	Finish: 606, 626, BSP
CR2500-031	CL3100 Series Vandal Resistant, CK4300 Knob	\$120.00
CR2500-033	CL3300, CL3500, CL3600 (June 2000 and after), CL3800, Lever Trim - A6/N6/PR6	
CR2500-033H	G10 Exit Device Knob Trim	
CR2500-034	CLX3300	
CR2500-037	CL3700 Lever, CK4700 Knob	
CR2500-039	CL3900	
CR2500-039L	CL3900 Lever (2" and 2-1/4" Thick Door)	
CR2500-044	CK4400	
CR2500-052	CK4200/UT5200	

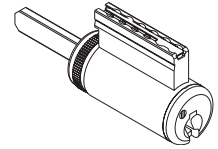

AP Fixed Core Deadlock Cylinder

Cylinder Number	Description	Finish: 606, 626, BSP
CR4500-134-A51	DL2200/DL3200 Series	\$120.00
CR4500-134-A52		
CR4500-214-A52		

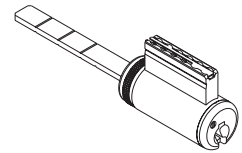

AP Fixed Core Hotel Cylinder

Cylinder Number	Description	Finish: 606, 626, BSP
CR2501-031	CL3100 Series Vandal Resistant	\$138.00
CR2501-034	CL3300, CLX3300	
CR2501-034A	CLX3300	

AP Fixed Core Component Cylinder for Other Manufacturer's Products

Cylinder Number	Description	Finish: 606, 626, BSP
CR2300-001-C21	Schlage D Series Lever Arrow H Series Knobs and Levers Sargent 10 Line ¹	\$287.00
CR2300-001-C22	Schlage AL and ND Series Levers	
CR2300-002-C21	Schlage D Series Knobs	
CR2300-002-C22	Schlage A Series Knobs (Ply, etc.)	
CR2300-002-C23	Schlage A Series Knobs (ORB only)	

1. SARGENT lock order must include 30- prefix.

AS Fixed Core - Mortise Cylinder

Cylinder Number	Description	605, 606, 611, 612, 613, 613E, 618, 619, 622, 625, 626, 629, 630, 722, BSP, WSP
CR1600-114	ML2000 Series mortise locks (including electrified and EAC devices)	\$214.00
CR1600-138	DL3000 and DL4100 deadlocks	
CR1600-112	ED5600, ED6600 and ED7600 exit devices	
CR1600-134	All ED5000 cylinder dogging, alarm units, delayed egress cylinders	
		\$224.00

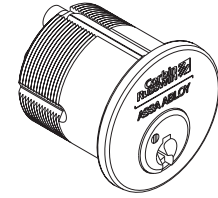

AS Fixed Core - Rim Cylinder

Cylinder Number	Description	605, 606, 611, 612, 613, 613E, 618, 619, 622, 625, 626, 629, 630, 722, BSP, WSP
CR3600-058	5/8" tailpiece	\$214.00
CR3600-138	1-3/8" M61 & M62 option for ED8200 and obsolete ED9200 exit device alarms; ED5202(A) inside cylinder	
CR3600-200	2" tailpiece	
CR3600-200N	2" night latch function	
CR3600-200V	2" vertical tailpiece	
CR3600-312	3-1/2" tailpiece	\$216.00
CR3600-312V	3-1/2" vertical tailpiece	

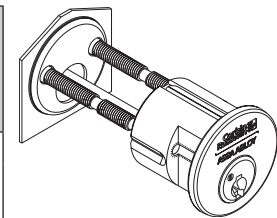

AS LFIC - Mortise Cylinder

Cylinder Number	Description	605, 606, 611, 612, 613, 613E, 618, 619, 622, 625, 626, 629, 630, 722, BSP, WSP
CR1680-114	ML2000 Series mortise locks (including electrified and EAC devices)	\$326.00
CR1680-138	DL3000 and DL4100 deadlocks	\$329.00
CR1680-112	ED5600, ED6600 and ED7600 exit devices	
CR1680-134	All ED5000 cylinder dogging, alarm units, delayed egress cylinders	\$337.00

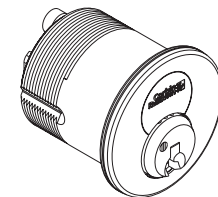

AS LFIC - Rim Cylinder

Cylinder Number	Description	605, 606, 611, 612, 613, 613E, 618, 619, 622, 625, 626, 629, 630, 722, BSP, WSP
CR3680-058	5/8" tailpiece	\$326.00
CR3680-114	1-1/4" M61 & M62 option for ED8200 and ED9200 exit device alarms	
CR3680-178	1-7/8" tailpiece	
CR3680-178V	1-7/8" vertical tailpiece	
CR3680-318	3-1/8" tailpiece	
		\$328.00

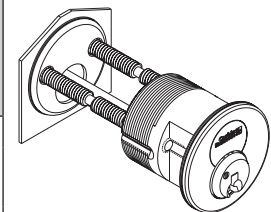

*LFIC Cores are provided in 606, 626 or BSP finish only.

AS LFIC Core

Cylinder Number	Description	Finish: 606, 626, BSP
CR8600	All Corbin Russwin LFIC Cylinders	\$196.00

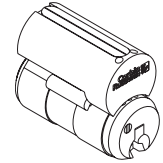

AS Fixed Core Component Cylinder

Cylinder Number	Description	Finish: 606, 626, BSP
CR2600-031	CL3100 Series Vandal Resistant, CK4300 Knob	\$212.00
CR2600-033	CL3300, CL3500, CL3600 (June 2000 and after), CL3800, Lever Trim - AG/NG/PR6	
CR2600-033H	G10 Exit Device Knob Trim	
CR2600-034	CLX3300	
CR2600-037	CL3700 Lever, CK4700 Knob	
CR2600-039	CL3900	
CR2600-039L	CL3900 Lever (2" and 2-1/4" Thick Door)	
CR2600-044	CK4400	
CR2600-052	CK4200/UT5200	

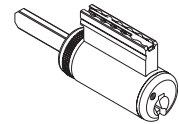

AS Fixed Core Deadlock Cylinder

Cylinder Number	Description	Finish: 606, 626, BSP
CR4600-134-A51	DL2200/DL3200 Series	\$212.00
CR4600-134-A52		
CR4600-214-A52		

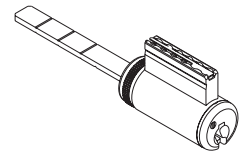

AS Fixed Core Hotel Cylinder

Cylinder Number	Description	Finish: 606, 626, BSP
CR2601-031	CL3100 Series Vandal Resistant	\$230.00
CR2601-034	CL3300, CLX3300	
CR2601-034A	CLX3300	

AS Fixed Core Component Cylinder for Other Manufacturer's Products

Cylinder Number	Description	Finish: 606, 626, BSP
CR2600-001-C21	Schlage D Series Lever Arrow H Series Knobs and Levers Sargent 10 Line ¹	\$357.00
CR2600-001-C22	Schlage AL and ND Series Levers	
CR2600-002-C21	Schlage D Series Knobs	
CR2600-002-C22	Schlage A Series Knobs (Ply, etc.)	
CR2600-002-C23	Schlage A Series Knobs (ORB only)	

1. SARGENT lock order must include 30- prefix.

AHS Fixed Core - Mortise Cylinder

Cylinder Number	Description	605, 606, 611, 612, 613, 613E, 618, 619, 622, 625, 626, 629, 630, 722, BSP, WSP
CR1700-114	ML2000 Series mortise locks (including electrified and EAC devices)	\$250.00
CR1700-138	DL3000 and DL4100 deadlocks	
CR1700-112	ED5600, ED6600 and ED7600 exit devices	\$260.00
CR1700-134	All ED5000 cylinder dogging, alarm units, delayed egress cylinders	

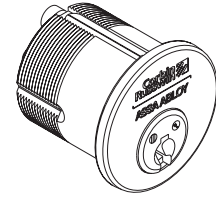

AHS Fixed Core - Rim Cylinder

Cylinder Number	Description	605, 606, 611, 612, 613, 613E, 618, 619, 622, 625, 626, 629, 630, 722, BSP, WSP
CR3700-058	5/8" tailpiece	\$250.00
CR3700-138	1-3/8" M61 & M62 option for ED8200 and obsolete ED9200 exit device alarms; ED5202(A) inside cylinder	
CR3700-200	2" tailpiece	
CR3700-200N	2" night latch function	
CR3700-200V	2" vertical tailpiece	
CR3700-312	3-1/2" tailpiece	\$252.00
CR3700-312V	3-1/2" vertical tailpiece	

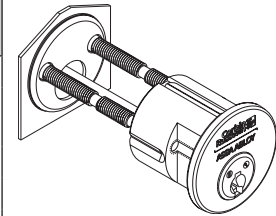

AHS LFIC - Mortise Cylinder

Cylinder Number	Description	605, 606, 611, 612, 613, 613E, 618, 619, 622, 625, 626, 629, 630, 722, BSP, WSP
CR1788-114	ML2000 Series mortise locks (including electrified and EAC devices)	\$362.00
CR1788-138	DL3000 and DL4100 deadlocks	\$365.00
CR1788-112	ED5600, ED6600 and ED7600 exit devices	
CR1788-134	All ED5000 cylinder dogging, alarm units, delayed egress cylinders	\$373.00

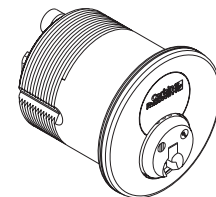

AHS LFIC - Rim Cylinder

Cylinder Number	Description	605, 606, 611, 612, 613, 613E, 618, 619, 622, 625, 626, 629, 630, 722, BSP, WSP
CR3788-058	5/8" tailpiece	\$362.00
CR3788-114	1-1/4" M61 & M62 option for ED8200 and ED9200 exit device alarms	
CR3788-178	1-7/8" tailpiece	
CR3788-178V	1-7/8" vertical tailpiece	
CR3788-318	3-1/8" tailpiece	
		\$364.00

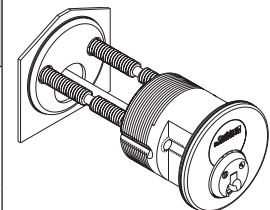

*LFIC Cores are provided in 606, 626 or BSP finish only.

AHS LFIC Core

Cylinder Number	Description	Finish: 606, 626
CR8700	All Corbin Russwin LFIC cylinders	\$232.00

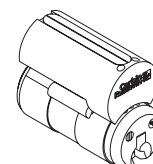

AHS Fixed Core Component Cylinder

Cylinder Number	Description	Finish: 606, 626, BSP
CR2700-031	CL3100 Series Vandal Resistant, CK4300 Knob	\$248.00
CR2700-033	CL3300, CL3500, CL3600 (June 2000 and after), CL3800, Lever Trim - A6/N6/PR6	
CR2700-033H	G10 Exit Device Knob Trim	
CR2700-034	CLX3300	
CR2700-037	CL3700 Lever, CK4700 Knob	
CR2700-039	CL3900	
CR2700-039L	CL3900 Lever (2" and 2-1/4" Thick Door)	
CR2700-044	CK4400	
CR2700-052	CK4200/UT5200	

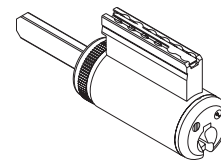

AHS Fixed Core Hotel Cylinder

Cylinder Number	Description	Finish: 606, 626, BSP
CR2701-031	CL3100 Series Vandal Resistant	\$266.00
CR2701-034	CL3300, CLX3300	
CR2701-034A	CLX3300	

AHS Fixed Core Deadlock Cylinder

Cylinder Number	Description	Finish: 606, 626, BSP
CR4700-134-A51	DL2200/3200 Series	\$248.00
CR4700-134-A52		
CR4700-214-A52		

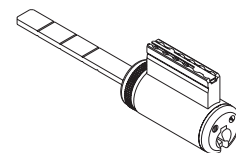

AHS Fixed Core Component Cylinder for Other Manufacturer's Products

Cylinder Number	Description	Finish: 606, 626
CR2900-001-C21	Schlage D Series Lever Arrow H Series Knobs and Levers Sargent 10 Line ¹	\$384.00
CR2900-001-C22	Schlage AL and ND Series Levers	
CR2900-002-C21	Schlage D Series Knobs	
CR2900-002-C22	Schlage A Series Knobs (Ply, etc.)	
CR2900-002-C23	Schlage A Series Knobs (ORB only)	

1. SARGENT lock order must include 30- prefix.

UL LFIC 6-Pin Mortise Housing

Cylinder Number	Description	605, 606, 611, 612, 613, 613E, 618, 619, 622, 625, 626, 629, 630, 722, BSP, WSP
CR1078-114	ML2000 Series mortise locks (including electrified and EAC devices)	\$130.00
CR1078-138	DL3000 and DL4100 deadlocks	\$133.00
CR1078-112	ED5600, ED6600 and ED7600 exit devices	
CR1078-134	All ED5000 cylinder dogging, alarm units, delayed egress cylinders	\$141.00

UL LFIC 6-Pin Rim Housing

Cylinder Number	Description	605, 606, 611, 612, 613, 613E, 618, 619, 622, 625, 626, 629, 630, 722, BSP, WSP
CR3078-058	5/8" tailpiece	\$130.00
CR3078-114	1-1/4" M61 & M62 option for ED8200 and ED9200 exit device alarms	
CR3078-178	1-7/8" tailpiece	
CR3078-178V	1-7/8" vertical tailpiece	
CR3078-318	3-1/8" tailpiece	

Fixed Core Mortise

7-Pin - No Cross Keying - Furnished standard with 610502 solid recessed collar unless otherwise indicated.
High Security UL437 Listed.

Cylinder Number Example

To simplify ordering, options designated "standard" may be omitted from the ordering sequence.

CR1020 - 114 - A01 - 626



Length		Cam		Finish	
114	(1-1/4")	A01	Cloverleaf (standard)	605	622
		A02	Straight	606	625
112	(1-1/2")	A03	Adams Rite® MS	611	626
		A04	DL4000 Deadlock	612	629
		A05	Adams Rite® 4070	613	630
		A06 ²	Schlage® L9000	613E	722
		A07	DL4100 Series Deadlock	618	BSP
		A62	Straight	619	WSP
		A92	Exit Grip O1, O2		
		A93 ¹	For Obsolete Corbin® 610 Series and Russwin®1403 Series Deadlock		
Cylinder No.				Price	
CR1020-114				\$265.00	

- Notes: 1. Add \$2.00 per cylinder for A93 cam
- 2. Add \$5.00 per cylinder for A06 cam

Fixed Core Rim

7-Pin - No Cross Keying - Furnished standard with 422F88 surface mount collar unless otherwise indicated.
High Security UL437 Listed.

Cylinder Number Example

CR3020 - 200 - 626

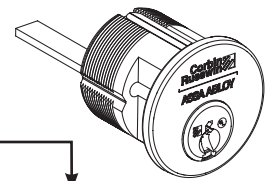

Tailpiece Length	Finish	
058 - 5/8"	605	622
138 - 1-3/8" M61 & M62 option for ED8200 and obsolete ED9200 exit device alarms	606	625
200 - 2"	611	626
	612	629
200N - 2" ED4000/ED5000 Night Latch Function	613	630
200V - 2" vertical	613E	722
312 - 3-1/2"	618	BSP
312V - 3-1/2" vertical	619	WSP
Cylinder Number	Price	
CR3020 - _____	\$265.00	

Key-In-Lever/Knob

7-Pin - No Cross Keying

High Security UL437 Listed

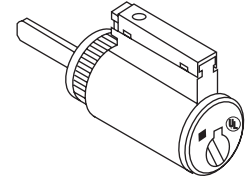

Cylinder Number	Used for	Finish: 606, 626
CR2020-031	CL3100 Lever, CK4300 Knob	\$251.00
CR2020-033	CL3300, CL3500, CL3800 [CL3600 (June 2000 and after)], A6, N6, PR6 Exit device trim	
CR2020-033H	G10 Exit device trim	
CR2020-034	CL3400, [CL3600 (prior to June 2000)], A5, N5 obsolete trims CLX3300	
CR2020-037	CL3700 Lever, CK4700 Knob	
CR2020-038	CL3800 Lever	
CR2020-039	CL3900 Lever	
CR2020-039L	CL3900 Lever (2" - 2-1/4" door)	
CR2020-051	G3 Exit Device Knob Trim	
CR2020-052	CK4200 Knob, UT5200 Knob and Lever	
CR4420-134-A51	DL2200, DL3200 Cylindrical Deadlock	
CR4420-134-A52	DL2200, DL3200 Cylindrical Deadlock	
CR4420-214-A52	DL2200, DL3200 Cylindrical Deadlock	

Key-In-Lever/Knob

For Other Manufacturers' Products

High Security UL437 Listed

Cylinder Number	Used for	Finish: 606, 626
CR2220-001-P21	Alarm Lock DL2500 Series	\$253.00
	Arrow® H Series Knobs and Levers	
	Arrow Q Series Levers	
	Sargent® 10 line*	
	Schlage® D Series Levers	
CR2220-002-P21	Schlage D Series Knobs	
CR2220-001-P22	Schlage AL and ND Series Levers	
CR2220-002-P22	Schlage A Series Knobs (PLY, etc.)	
CR2220-002-P23	Schlage A Series Knob (ORB only)	

* When ordered with a 30- prefix, this cylinder is accepted without modification to the lever.

*LFIC Cores are provided in 606 or 626 finish only.

IC Mortise

7-Pin - No Cross Keying - Furnished standard with 610F02 solid recessed collar unless otherwise indicated.

Cylinder Number Example

To simplify ordering, options designated "standard" may be omitted from the ordering sequence.

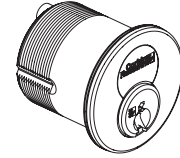

Length		Cam		Finish	
114	1-1/4"	A01	Cloverleaf (standard)	605	622
138	1-3/8"	A02	Straight	606	625
112	1-1/2"	A03	Adams Rite® MS & DL3000	611	626
134	1-3/4"	A04	DL4000 Deadlock	612	629
		A05	Adams Rite® 4070	613	630
		A06 ²	Schlage® L9000	613E	722
		A07	DL4100 Series Deadlock	618	BSP
		A62	Straight	619	WSP
		A92	Exit Grip 01, 02		
		A93 ¹	For Obsolete Corbin® 610 Series and Russwin® 1403 Series Deadlock		
Cylinder Number				Price	
CR1030-114				\$371.00	

Notes: 1. Add \$2.00 per cylinder for A93 cam.
2. Add \$5.00 per cylinder for A06 cam.

IC Rim

7-Pin - No Cross Keying - Furnished standard with 422F88 surface mount collar unless indicated.

Cylinder Number Example

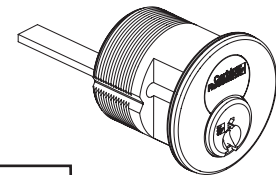

Tailpiece Length	Finish
058 - 5/8"	605 622 606 625
114 - 1-1/4" M61 & M62 option for ED8200 and ED9200 exit device alarms	611 626 612 629
178 - 1-7/8"	613 630
178V - 1-7/8" vertical	613E 722
318 - 3-1/8"	618 BSP 619 WSP
Cylinder Number	Price
CR3030-_____	\$371.00

Pyramid Core Only – Finish: 606, 626, BSP

Cylinder Number	Price
CR8020	\$239.00

Note: For mortise and rim housing only, see page 58.

*LFIC Cores are provided in 606 or 626 finish only.

Fixed Core Mortise

7-Pin - No Cross Keying - Furnished standard with 605F43 spring collar unless otherwise indicated.

Cylinder Number Example

To simplify ordering, options designated "standard" may be omitted from the ordering sequence.

CR1027 - 114 - A01 - 626



Length	Cam	Finish	
114 (1-1/4")	A01 Cloverleaf (standard)	605	622
	A02 Straight	606	625
112 (1-1/2")	A03 Adams Rite® MS	611	626
	A04 DL4000 Deadlock	612	629
	A05 Adams Rite 4070	613	630
	A06 ² Schlage® L9000	613E	722
	A07 DL4100 Series Deadlock	618	BSP
	A62 Straight	619	
	A92 Exit Grip O1, O2		
	A93 ¹ For Obsolete Corbin® 610 Series and Russwin® 1403 Series Deadlock		

Cylinder Number	Price
CR1027-114	\$220.00

- Notes: 1. Add \$2.00 per cylinder for A93 cam.
2. Add \$5.00 per cylinder for A06 cam.

Fixed Core Rim

7-Pin - No Cross Keying - Furnished standard with 422F88 surface mount collar unless otherwise indicated.

Cylinder Number Example

CR3027 - 200 - 626

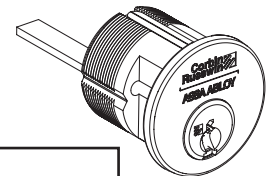

Tailpiece Length	Finish	
058 - 5/8"	605	622
138 - 1-3/8" M61 & M62 option for ED8200 and obsolete ED9200 exit device alarms	606	625
200 - 2"	611	626
200N - 2" ED4000/ED5000 Night Latch Function	612	629
200V - 2" (vertical)	613	630
312 - 3-1/2"	613E	722
312V - 3-1/2" (vertical)	618	BSP
	619	

Cylinder Number	Price
CR3027-_____	\$220.00

Key-In-Lever/Knob

7-Pin - No Cross Keying.

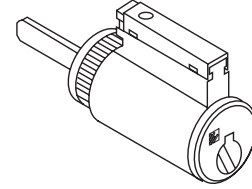

Cylinder Number	Used for	Finish: 606, 626, BSP
CR2027-031	CL3100 Lever, CK4300 Knob	\$210.00
CR2027-033	CL3300, CL3500, CL3800 [CL3600 (June 2000 and after)], A6, N6, PR6 Exit Device Trim	
CR2027-033H	G10 Exit device trim	
CR2027-034	CL3400, [CL3600 (before June 2000)], A5, N5 obsolete trims CLX3300	
CR2027-037	CL3700 Lever, CK4700 Knob	
CR2027-038	CL3800 Lever	
CR2027-039	CL3900 Lever	
CR2027-039L	CL3900 Lever (2" - 2-1/4" door)	
CR2027-051	G3 Exit Device Knob Trim	
CR2027-052	CK4200 knob, UT5200 Knob and Lever	
CR4427-134-A51	DL2200, DL3200 Cylindrical Deadlock	
CR4427-134-A52	DL2200, DL3200 Cylindrical Deadlock	
CR4427-214-A52	DL2200, DL3200 Cylindrical Deadlock	

Key-In-Lever/Knob

For Other Manufacturer's Products

Cylinder Number	Used for	Finish: 606, 626, BSP
CR2227-001-P21	Alarm Lock DL2500 Series	\$212.00
	Arrow® H Series Knobs and Levers	
	Arrow Q Series Levers	
	Sargent® 10 line (Enlarge Lever Hole)	
	Schlage® D Series Levers	
CR2227-002-P21	Schlage D Series Knobs	
CR2227-001-P22	Schlage AL and ND Series Levers	
CR2227-002-P22	Schlage A Series Knobs (PLY, etc.)	
CR2227-002-P23	Schlage A Series Knob (ORB only)	

IC Mortise

7-Pin - No Cross Keying - Furnished standard with 605F43 spring collar unless otherwise indicated.

Cylinder Number Example

To simplify ordering, options designated "standard" may be omitted from the ordering sequence.

CR1037 - 114 - A01 - 626

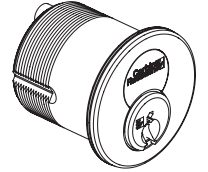

Length	Cam		Finish	
114 1-1/4"	A01	Cloverleaf (standard)	605	622
138 1-3/8"	A02	Straight	606	625
112 1-1/2"	A03	Adams Rite® MS & DL3000	611	626
134 1-3/4"	A04	DL4000 Deadlock	612	629
	A05	Adams Rite® 4070	613	630
	A06 ²	Schlage® L9000	613E	722
	A07	DL4100 Series Deadlock	618	BSP
	A62	Straight	619	
	A92	Exit Grip 01, 02		
	A93 ¹	For Obsolete Corbin® 610 Series and Russwin® 1403 Series Deadlock		
Cylinder Number			Price	
CR1037-114			\$326.00	

- Notes: 1. Add \$2.00 per cylinder for A93 cam.
2. Add \$5.00 per cylinder for A06 cam.

IC Rim

7-Pin - No Cross Keying - Furnished standard with 422F88 surface mount collar unless otherwise indicated.

Cylinder Number Example

CR3037 - 178 - 626

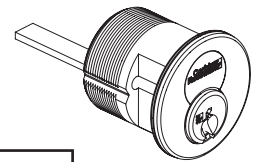

Tailpiece Length	Finish	
058 - 5/8"	605	622
	606	625
114 - 1-1/4" M61 & M62 option for ED8200 and ED9200 exit device alarms	611	626
178 - 1-7/8"	612	629
	613	630
178V - 1-7/8" vertical	613E	722
318 - 3-1/8"	618	BSP
	619	

Cylinder Number	Price
CR3037-_____	\$326.00

Pyramid Core Only

Cylinder Number	Price
CR8027	\$196.00

Note: For mortise and rim housing only, see page 58.

Standard Mortise

Cylinder Number Example

To simplify ordering, options designated "standard" may be omitted from the ordering sequence.



CR1000 - 118 - A01 - 6 - L4



Length	Cam	Pins	Keyway
100 1" (5-pin only)	A01 Cloverleaf (standard)	5	L4
118 1-1/8" (standard)	A02 Straight	6 (standard)	(standard)
114 1-1/4"	A03 Adams Rite® MS	7	
138 1-3/8"	A04 DL4000 Deadlock		
112 1-1/2"	A05 Adams Rite 4070		
134 1-3/4"	A06 ² Schlage® L9000		
200 2"	A07 DL4100 Series Deadlock		
	A62 Straight		
214 2-1/4"	A92 Exit Grip O1, O2		
212 2-1/2"	A93 ¹ For Obsolete		
234 2-3/4"	Corbin® 610 Series and Russwin®		
300 3"	1403 Series Deadlock		
314 3-1/4"			
312 3-1/2"			
334 3-3/4"			

Cylinder Number	Finish: 605, 606, 611, 612, 613, 613E, 618, 619, 622, 625, 626, 629, 630, 722, BSP, WSP	
	5- OR 6-PIN	7-PIN
CR1000-100-__-5- Keyway	\$130.00	Not Available
CR1000-118-__- Keyway		
CR1000-114-__- Keyway	\$130.00	\$132.00
CR1000-138-__- Keyway		
CR1000-112-__- Keyway	\$140.00	\$142.00
CR1000-134-__- Keyway		
CR1000-200-__- Keyway	\$150.00	\$152.00
CR1000-214-__- Keyway		
CR1000-212-__- Keyway	\$160.00	Not Available
CR1000-234-__- Keyway		
CR1000-300-__- Keyway	\$160.00	Not Available
CR1000-314-__- Keyway		
CR1000-312-__- Keyway	\$160.00	Not Available
CR1000-334-__- Keyway		

- Notes:
 1. Add \$2.00 per cylinder for A93 cam.
 2. Add \$5.00 per cylinder for A06 cam.

Flexible Head Mortise

Cylinder Number Example

To simplify ordering, options designated "standard" may be omitted from the ordering sequence.

CR1100 - 118 - A01 - 6 - L4



Length	Cam	Pins	Keyway
100 1" (6-pin standard)	A01 Cloverleaf (standard)	5	L4
118 1-1/8"	A02 Straight	6 (standard)	(standard)
114 1-1/4"		7	

Cylinder Number	Finish: 605, 606, 611, 612, 613, 613E, 618, 619, 622, 625, 626, 722, BSP, WSP	
	5- OR 6-PIN	7-PIN
CR1100-100-__ - __ - Keyway	\$246.00	Not Available
CR1100-118-__ - __ - Keyway		\$248.00
CR1100-114-__ - __ - Keyway		\$250.00

Concealed Shell Mortise

Cylinder Number Example

To simplify ordering, options designated "standard" may be omitted from the ordering sequence.

CR1200 - 118 - A01 - 6 - L4



Length	Cam	Pins	Keyways
100 1" (5-pin standard)	A01 Cloverleaf (standard)	5	L4
118 1-1/8" (6-pin standard)	A02 Straight	6 (standard)	(standard)
114 1-1/4"		7	
138 1-3/8"			
112 1-1/2"			

Cylinder Number	Finish: 606, 626	
	5- OR 6-PIN	7-PIN
CR1200-100-__ - 5 - Keyway	\$196.00	N/A
CR1200-118-__ - __ - Keyway		
CR1200-114-__ - __ - Keyway		
CR1200-138-__ - __ - Keyway		
CR1200-112-__ - __ - Keyway		\$198.00

Special Function Mortise

Hotel Function* Cylinders

To simplify ordering, you may specify only the first 4 digits (1001, 1101, 1201).

Cylinder Number	Description	605, 606, 611, 612, 613, 613E, 618, 619, 622, 625, 626, 629, 630, 722, BSP, WSP
CR1001-114-A01	Standard	\$191.00
CR1101-118-A01	Flex Head	\$221.00
CR1201-118-A01	Concealed Shell	\$206.00

* Not available with D1, D2, L1, L2, 752, 852 or A class keyways.

Cylinder for Discontinued Exit Device

Inside of Corbin® 3726-1/2, 3727-1/2 and Russwin® 736-1/2, 737-1/2

Cylinder Number	605, 606, 611, 612, 613, 613E, 618, 619, 622, 625, 626, 629, 630, 722, BSP, WSP
CR1006-118-A02	\$160.00

Non-Keyed Mortise

Thumbturn Cylinders

Cylinder Number	Description	605, 606, 611, 612, 613, 613E, 618, 619, 622, 625, 626, 629, 630, 722, BSP, WSP
CR1300-100-A02	Standard*	\$130.00
CR1300-118-A02		
CR1300-114-A02	Standard*	\$134.00
CR1300-138-A02		
CR1300-100-A03	Standard*	\$130.00
CR1300-118-A03		
CR1300-114-A03	Standard*	\$134.00
CR1300-138-A03		
CR1300-118-A93	Standard*	\$132.00
CR1303-100-A03	Classroom*	
CR1303-118-A03		
CR1303-114-A03	Classroom*	\$136.00
CR1303-138-A03		

Dummy Cylinders

Cylinder Number	605, 606, 611, 612, 613, 613E, 618, 619, 625, 626, 629, 630, 722, BSP, WSP
CR1400-118	\$111.00
CR1400-114	\$115.00
CR1400-138	\$119.00

Rim Thumbturn Cylinders

Cylinder Number	605, 606, 611, 612, 613, 613E, 618, 619, 625, 626, 629, 630, 722, BSP, WSP
CR3300 -138	\$130.00
CR3300-138-M34	\$152.00
CR3300-200	\$130.00
CR3300-200-M34	\$152.00

* All CR1300 and CR1303 are available with M34 Ergonomic Thumbturn.

Rim (.552 dia. Plug)

Cylinder Number Example

To simplify ordering, options designated "standard" may be omitted from the ordering sequence.

CR3000 - 200 - 6 - L4

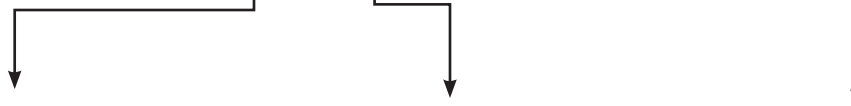
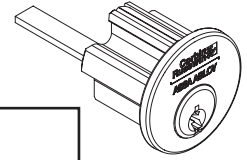

Tailpiece Length		Pins	Keyway
058	5/8"	5	L4 (Standard)
138	1-3/8" M61 & M62 option for ED8200 and obsolete ED9200 Exit Device Alarms	6 (Standard)	
		7	
200	2" (Standard)		
200N	2" ED4000/ED5000 Night Latch Function		
200V	2" Vertical		
312	3-1/2" (Thick door)		
312	3-1/2" (Thick door) Vertical		

Cylinder No.	605, 606, 611, 612, 613, 613E, 618, 619, 622, 625, 626, 629, 630, 722, BSP, WSP	
	5- OR 6-PIN	7-PIN
CR3000-058 __ - Keyway	\$130.00	\$132.00
CR3000-138 __ - Keyway		
CR3000-200- __ - Keyway		
CR3000-200N- __ - Keyway		
CR3000-200V- __ - Keyway		
CR3000-312- __ - Keyway	\$132.00	\$134.00
CR3000-312V- __ - Keyway		

Key-In-Lever/Knob (.509" plug)

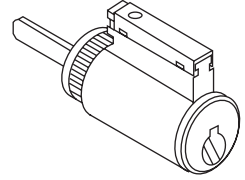

Cylinder Number		Finish: 606, 626, BSP		
		Series	6-PIN	7-PIN ⁴
CR2000-031	Standard	CL3100, CK4300	\$120.00	\$122.00
CR2001-031 ¹	Hotel	CL3100	\$138.00	\$140.00
CR2400-031-C ²	Schlage® C Keyway	CL3100	\$120.00	Not Available
CR2400-031-LA ³	Sargent® LA Keyway	CL3100		
CR2000-033	Standard	CL3300, CL3500, CL3600, CL3800 ^B		
CR2000-034	Standard	CLX3300		\$122.00
CR2000-038	Standard	CL3800 ^A		
CR2001-034 ¹	Hotel	CL3300, CLX3300		\$138.00
CR2400-033-C ^{2,5}	Schlage® C keyway	CL3300, CL3500, CL3600, CL3800 ^B	\$120.00	Not Available
CR2400-033-LA ^{3,5}	Sargent® LA keyway			
CR2000-037	Standard	CL3700, CK4700		
CR2400-037-C ^{2,5}	Schlage® C keyway			
CR2400-037-LA ⁵	Sargent® LA keyway			
CR2000-039	Standard	CL3900		
CR2000-039L	2" to 2-1/4" Door			
CR2400-039-C ^{2,5}	Schlage® C keyway			
CR2400-039-LA ^{3,5}	Sargent® LA keyway			
CR2000-034	Standard	CL3400, CL3600, CLX3300 (Prior to June 2000)		
CR2001-034 ¹	Hotel		\$138.00	\$140.00
CR2400-034-C ^{2,5}	Schlage® C keyway		\$120.00	Not Available
CR2400-034-LA ^{3,5}	Sargent® LA keyway			

Notes:

1. Not available in 752, 852 or A Class keyways.
2. Available 0-bitted & keyed random only.
3. Available 0-bitted only.
4. For 7-pin version suffix "-7" to number. Not available in 752, 852 or A Class keyways.
5. Available in 606 or 626 finish only.
- A. CL3800 manf. 1993-1997
- B. CL3800 manf. 2006 -

Cylindrical Deadlocks DL2200, DL3200 Series

Cylinder Number		Door Thickness	Function	Finish: 606, 626, BSP Price
CR4400-134-A51	6-Pin Conventional	All	11, 13, 17	\$120.00
CR4400-134-A52	6-Pin Conventional	1-3/8" to 1-3/4"	12	
CR4400-214-A52	6-Pin Conventional	2" to 2-1/4"	12	
CR4400-134-A51-7	7-Pin Conventional	All	11, 13, 17	\$122.00
CR4400-134-A52-7	7-Pin Conventional	1-3/8" to 1-3/4"	12	
CR4400-214-A52-7	7-Pin Conventional	2" to 2-1/4"	12	

Key-In-Lever/Knob

For UT5200 & CK4200 Series Locksets (.552" dia plug)

Cylinder Number	Description	Finish: 606, 626, BSP
CR2000-052	Standard	\$120.00
CR2001-052*	Hotel with Indicator	\$138.00
CR2100-052**	Discontinued Ronde & Continental Knob	\$138.00

For CK4400 Series Locksets (.509" dia plug)

Cylinder Number	Description	Finish: 606, 626, BSP
CR2000-044	All except below	\$120.00
CR2003-044	CK4455 & CK4482 before 8/93	
CR2001-044*	CK4429 with Indicator Pin New Style Straight Tailpiece	\$138.00
CR2001-066*	CK4429 with Indicator Pin Old Style Twisted Tailpiece	

For G10 Exit Device Knob Trim

Cylinder Number	Description	Finish: 606, 626, BSP
CR2000-033H	Standard	\$120.00

* Not available with 752, 852 or A Class keyways.

** Also available in 605, 611, 612, 613, 625 finishes. Not available with X Class keyways.

For PL5000 Series Rekeyable Fixed Core Padlocks

Cylinder Number	Description	Finish: 606, 626, BSP
CR2300PL	Standard 6-pin	\$120.00

For B2, G2, G3 Exit Device Trim

Cylinder Number	Description	Finish: 606, 626, BSP
CR2000-051	Standard 6-pin	\$120.00

Key-In-Lever/Knob (.552 dia Plug)

For Other Manufacturers' Products

Cylinder Number	Description	Finish: 606, 626, BSP
CR2200-001-A21	Alarm Lock DL2500 Series	\$124.00
	Arrow® H Series Knobs and Levers	
	Arrow Q Series Levers	
	Sargent® 10 line*	
	Schlage® D Series Levers	
CR2200-001-A22	Schlage AL and ND Series Levers	
CR2200-002-A21	Schlage D Series Knobs	
CR2200-002-A23	Schlage A Series Knobs (ORB only)	
CR2200-002-A22	Schlage A Series Knobs (PLY, etc.)	
CR2200-003-A24	Lockwood® H Series Knobs (Enlarge Knob Hole)	
CR2200-008	Sargent 7, 8, 9 Line (Enlarge Knob Hole)	
CR2200-054	ASSA ABLOY ACCENTRA™ 5400, 6200 Knobs Only (Enlarge Knob Hole)	
CR2200-076	Sargent 7600 Integralock	\$130.00

* When ordered with a 30- prefix, this cylinder is accepted without modification to the lever.

For Adams Rite® 4025 Pull (.552" dia. Plug)

Cylinder Number	Description	Finish: 606, 626, BSP
CR4200-003-A47	Cylinder & Housing	\$205.00
CR4200-002-A47	Cylinder Only	\$120.00

LFlC Cores are provided in 606, 626, or BSP finish only.

IC Mortise

For Construction Core Program, see page 28.
For housing only, see page 58-59.

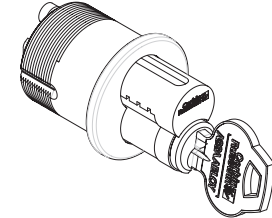

Cylinder Number Example

To simplify ordering, options designated "standard" may be omitted from the ordering sequence.

CR1080 - 114 - A01 - 6 - L4



Length	Cam	Pins	Keyway
114 1-1/4" (6-pin standard)	A01 Cloverleaf (standard)	6 (standard)	L4 (standard)
138 1-3/8"	A02 Straight	7**	
112 1-1/2"	A03 Adams Rite® MS & DL300		
134 1-3/4"	A04 DL4000 Deadlock		
200 2"	A05 Adams Rite 4070		
214 2-1/4"	A06 ² Schlage® L9000		
212 2-1/2"	A07 DL4100 Series Deadlock		
234 2-3/4"	A62 Straight		
	A92 Exit Group 01, 02		
	A93 ¹ For obsolete Corbin® 610 Series and Russwin® 1403 Series Deadlocks		

Cylinder Number	605, 606, 611, 612, 613, 613E, 618, 619, 622, 625, 626, 629, 630, 722, BSP, WSP	
	6- PIN	7-PIN
CR1080-114-	\$242.00	Not Available
CR1080-138-	\$245.00	Not Available
CR1080-112-__-	\$245.00	\$249.00
CR1080-134-__-	\$253.00	\$257.00
CR1080-200-	\$253.00	\$257.00
CR1080-214-	\$259.00	\$263.00
CR1080-212-	\$265.00	\$269.00
CR1080-234-	\$269.00	\$273.00

Notes:

- 1. Add \$2.00 per cylinder for A93 Cam.
- 2. Add \$5.00 per cylinder for A06 Cam.

Hotel Function IC Mortise

To simplify ordering, options designated "standard" may be omitted from the ordering sequence.

Cylinder Number	605, 606, 611, 612, 613, 613E, 618, 619, 622, 625, 626, 629, 630, 722, BSP, WSP	
	6-PIN	7-PIN
CR1081-138-A01-6** (Hotel function uses E1-suffix EMK blank)	\$260.00	Not Available

- ** Not available with 752, 852 or A Class keyways.
- ** Only available in 1-1/2" and 1-3/4" length.

*LFIC Cores are provided in 606 or 626 finish only.

IC Rim

For Construction Core Program, see page 28.
For housing only, see page 58-59.

Cylinder Number Example

To simplify ordering, options designated "standard" may be omitted from the ordering sequence.

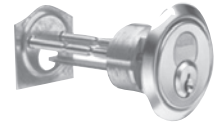

CR3080 - 178 - 6 - L4

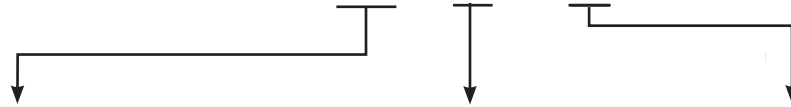

Tailpiece Length		Pins	Keyway
058	5/8" Tailpiece	6 Pin (standard) 7 Pin	L4 (standard)
178	1-7/8" (standard)		
178V	1-7/8" Vertical		
318	3-1/8" (Thick door)		
114	1-1/4" M61 & M62 option for ED8200 and obsolete ED9200 exit device alarms		

Cylinder Number	605, 606, 611, 612, 613, 613E, 618, 619, 622, 625, 626, 629, 630, 722, BSP, WSP	
	6 PIN	7 PIN
CR3080-058-	\$242.00	\$246.00
CR3080-178-__		
CR3080-178V-__		
CR3080-318-__	\$244.00	\$248.00
CR3080-114-__ (no back plate or screw)	\$244.00	\$248.00

Core Only



Cylinder Number (specify keyway)		Finish: 626, 606, BSP
CR8000	6-Pin Standard	\$112.00
CR8000EMK*	6-Pin Standard set to hotel mortise EMK	
CR8000-7	7-Pin	\$114.00
CR8001-034*	6-Pin for CL3329, hotel indicator pin	\$130.00
CR8001-034-7*	7-Pin for CL3329, hotel indicator pin	\$132.00
CR8001-042*	6-Pin for CK4229, hotel indicator pin	\$130.00

* Not available with 752, 852 or A Class keyways.

Note: For uncombined cores suffix "UC". See page 29 for deduct.

*SFIC Cores are provided in 606 or 626 finish only.

SFIC Mortise

For Construction Core Program, see page 28.
For housing only, see page 58-59.

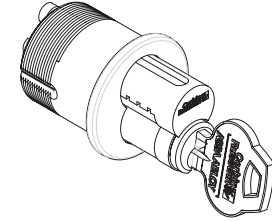

Cylinder Number Example

To simplify ordering, options designated "standard" may be omitted from the ordering sequence.

CR1050 - 114 - A01 - 6 - A



Length	Cam	Pins	Keyway
114 1-1/4" (6-pin standard)	A01 Cloverleaf (standard)	6 (standard)	A, B, C, D, E, F, G, H, J, K, L, M
138 1-3/8"	A02 Straight	7**	
112 1-1/2"	A03 Adams Rite® MS & DL300		
134 1-3/4"	A04 DL4000 Deadlock		
	A05 Adams Rite 4070		
	A06 ² Schlage® L9000		
	A07 DL4100 Series Deadlock		
	A62 Straight		
	A92 Exit Group 01, 02		
	A93 ¹ For obsolete Corbin® 610 Series and Russwin® 1403 Series Deadlocks		
Cylinder Number	605, 606, 611, 612, 613, 613E, 618, 619, 622, 625, 626, 629, 630, 722, BSP, WSP		
	6- PIN	7-PIN	
CR1050-114-	\$231.00	Not Available	
CR1050-138-	\$234.00	\$236.00	
CR1050-112-	\$234.00	\$236.00	
CR1050-134-	\$242.00	\$244.00	

Notes:

1. Add \$2.00 per cylinder for A93 Cam.
2. Add \$5.00 per cylinder for A06 Cam.

*SFIC Cores are provided in 606 or 626 finish only.

SFIC Rim

For Construction Core Program, see page 28.
For housing only, see page 58-59.

Cylinder Number Example

To simplify ordering, options designated "standard" may be omitted from the ordering sequence.

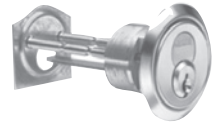

CR3050 - 178 - 6 - A

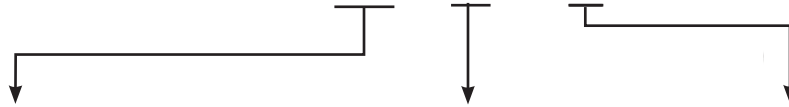

Tailpiece Length		Pins	Keyway
058	5/8" Tailpiece	6 Pin (standard) 7 Pin	A, B, C, D, E, F, G, H, J, K, L, M
178	1-7/8" (standard)		
318	3-1/8" (Thick door)		

Cylinder Number	605, 606, 611, 612, 613, 613E, 618, 619, 622, 625, 626, 629, 630, 722, BSP, WSP	
	6 PIN	7 PIN
CR3050-058-	\$231.00	\$233.00
CR3050-178-	\$231.00	\$233.00
CR3050-318-	\$233.00	\$235.00

SFIC Core Only



Cylinder Number (specify keyway)		Finish: 626, 606
CR8200	6-Pin Standard	\$101.00
CR8200-7	7-Pin	

Note: For uncombined cores suffix "UC". See page 29 for deduct

LFIC Mortise Housing Only

Housing Number Example

To simplify ordering, options designated "standard" may be omitted from the ordering sequence.

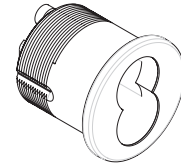

CR1070 - 114 - A01 - 6

Length	Cam		Pins
114 1-1/4" (6-pin standard)	A01	Cloverleaf (standard)	6 (standard)
138 1-3/8"	A02	Straight	7
112 1-1/2"	A03	Adams Rite® MS	
134 1-3/4"	A04	DL4000 Deadlock	
214 2-1/4"	A05	Adams Rite® 4070	
	A06 ²	Schlage® L9000	
	A07	DL4100 Series Deadlock	
	A62	Straight	
	A92	Exit Group 01, 02	
	A93 ¹	For obsolete Corbin® 610 Series and Russwin® 1403 Series Deadlocks	

Cylinder Number	605, 606, 611, 612, 613, 613E, 618, 619, 622, 625, 626, 629, 630, 722, BSP, WSP	
	6 PIN	7 PIN
CR1070-114-	\$130.00	Not Available
CR1070-138-	\$133.00	
CR1070-112-__-	\$133.00	\$135.00
CR1070-134-__-	\$141.00	\$143.00
CR1070-214-	\$147.00	Not Available
CR1071-138-A01 (Hotel function uses -E1 suffix EMK blank)	\$148.00	

Notes:

To simplify ordering, you may specify only "1071" since no length or cam variations exists.

1. Add \$2.00 per cylinder for A93 Cam.
2. Add \$5.00 per cylinder for A06 Cam.

LFIC Rim Housing Only

CR3070 - 058 - 626

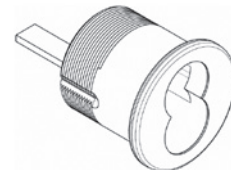

Cylinder Number	605, 606, 611, 612, 613, 613E, 618, 619, 622, 625, 626, 629, 630, 722, BSP, WSP	
	6 PIN	7 PIN
CR3070-058- 5/8" tailpiece	\$130.00	\$132.00
CR3070-178-__ 1-7/8" tailpiece (standard)		
CR3070-178V-__ 1-7/8" vertical		
CR3070-318-__ 3-1/8" tailpiece (thick door)	\$132.00	\$134.00
CR3070-114-__ 1-1/4" tailpiece for M61, M62 exit alarm options. No back plate or screws.		

SFIC Mortise Housing Only

Cylinder Number Example

CR1040 - 114 - A01 - 6

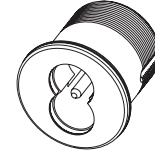

Length	Cam	Pins
114 1-1/4" (6-pin standard)	A01 Cloverleaf (standard)	6 (standard)
	A02 Straight	
	A03 Adams Rite® MS	
	A04 DL4000 Series Deadlock	
	A05 Adams Rite 4070	
	A06 Schlage® L9000	
	A07 DL4100 Series	
	A62 MR Straight	
	A93 Obsolete Deadlocks Corbin® 610 Series and Russwin® 1403 Series	
138 1-3/8" (7-pin standard) 112 1-1/2" (7-pin standard) 134 1-3/4" (7-pin standard)	A01 Cloverleaf (standard)	7
	A02 Straight	
	A03 Adams Rite® MS	
	A04 DL4000 Series Deadlock	
	A05 Adams Rite 4070	
	A06 Schlage® L9000	
	A07 DL4100 Series	
	A62 MR Straight	
	A93 Obsolete Deadlocks Corbin® 610 Series and Russwin® 1403 Series	

Cylinder Number	605, 606, 611, 612, 613, 613E, 618, 619, 622, 625, 626, 629, 630, 722, BSP, WSP	
	6 PIN	7 PIN
CR1040-114-__-	\$130.00	Not Available
CR1040-138-__-	\$133.00	\$135.00
CR1040-112-__-	\$133.00	\$135.00
CR1040-134-__-	\$141.00	\$143.00

SFIC Rim Housing Only

CR3040 - 058 - 626

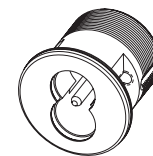

Cylinder Number		605, 606, 611, 612, 613, 613E, 618, 619, 622, 625, 626, 629, 630, 722, BSP, WSP	
		6 PIN	7 PIN
CR3040-058-	5/8" tailpiece	\$130.00	\$132.00
CR3040-178-__	1-7/8" tailpiece	\$130.00	\$132.00
CR3040-318-__	3-1/8" tailpiece	\$132.00	\$134.00

Standard Security Mortise

For Existing Systems Only.*
For uncombined cylinders, suffix "UC".
See page 29 for deduct.

6-Pin Only - No Cross Keying - Available in Z and DH Class Keyways only.
Available UC or master keyed only.
Not available KR or 0-bitted.

* L4, D1 and 60 keyway sections may be ordered Keyed Random only, without prior Key Systems Administration approval

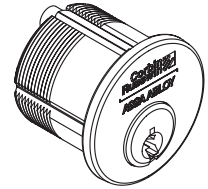

Cylinder Number Example

To simplify ordering, options designated "standard" may be omitted from the ordering sequence.

CR1010 - 118 - A01 - L4

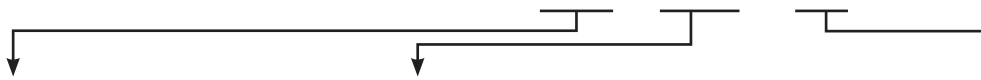

Length		Cam		Keyway
118	1-1/8" (standard)	A01	Cloverleaf (standard)	L4 (standard) Available only with Z and DH Class keyways.
114	1-1/4"	A02	Straight	
138	1-3/8"	A03	Adams Rite® MS & DL3000	
112	1-1/2"	A04	DL4000 Deadlock	
134	1-3/4"	A05	Adams Rite 4070	
200	2"	A06 ²	Schlage® L9000	
214	2-1/4"	A07	DL4100 Series Deadlock	
		A62	Straight	
		A92	Exit Grip 01, 02	
212	2-1/2"	A93 ¹	For obsolete Corbin® 610 Series and Russwin® 1403 Series Deadlocks	
234	2-3/4"			

Cylinder Number	605, 606, 611, 612, 613, 613E, 618, 619, 622, 625, 626, 629, 630, 722, BSP, WSP
CR1010-118-__	\$301.00
CR1010-114-__	
CR1010-138-__	\$309.00
CR1010-112-__	\$331.00
CR1010-134-__	\$341.00
CR1010-200-__	\$347.00
CR1010-214-__	\$353.00
CR1010-212-__	\$361.00
CR1010-234-__	\$365.00

- Notes:
1. Add \$2.00 per cylinder for A93 Cam.
 2. Add \$5.00 per cylinder for A06 Cam.

Special Function Security Mortise

For Existing Systems Only.*
 6-Pin Only - No Cross Keying - Available in Z and DH Class Keyways only.
 Available UC or master keyed only.
 Not available KR or O-bitted.
 * L4, D1 and 60 keyway sections may be ordered Keyed Random only, without prior Key Systems Administration approval

Hotel Function Cylinders

Cylinder Number	Description	605, 606, 611, 612, 613, 613E, 618, 619, 622, 625, 626, 629, 630, 722, BSP, WSP
CR1011-114-A01	1-1/4" Cloverleaf cam only	\$323.00

To simplify ordering, you may specify only "1011" since no length or cam variations exist.
 For uncombined cylinders, suffix "UC". See page 29 for deduct.
 Not available in D1, D2, L1 or L2 keyways.

Security Rim

For Existing Systems Only.*

6-Pin Only - No Cross Keying - Available in Z and DH Class Keyways Only.
Available UC or master keyed only. Not available KR or 0-bitted.

* L4, D1 and 60 keyway sections may be ordered Keyed Random only, without prior Key Systems Administration approval

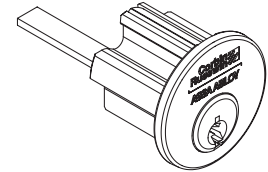

Cylinder Number Example

To simplify ordering, options designated "standard" may be omitted from the ordering sequence.

CR3010 - 200 - L4

Function	Tailpiece Length	Keyway
For 3010 Only:	For 3010 Only:	L4 (standard) Available only with Z and DH Class keyways.
0 (standard)	200 2" (standard)	
	200V 2" vertical	
	312 3-1/2" (thick door)	
	312V 3-1/2" (thick door) vertical	
	058 5/8" Tailpiece	
	138 1-3/8" M61 and M62 option for ED8200 and obsolete ED9200 exit device alarms	
	For 3012 Only:	
	178 1-7/8" (standard)	
	178V 1-7/8" vertical	
	318 3-1/8" (thick door)	
	318V 3-1/8" (thick door) vertical	

Cylinder Number	605, 606, 611, 612, 613, 613E, 618, 619, 622, 625, 626, 629, 630, 722, BSP, WSP
CR3010-058-__	\$301.00
CR3010-200-__	
CR3010-200V-__	
CR3010-312-__	\$303.00
CR3010-312V-__	
CR3010-138-__ No back plate or screws	\$301.00
CR3012-178-__	\$309.00
CR3012-178V-__	
CR3012-318-__	\$311.00
CR3012-318V-__	

Security Key-In-Lever/Knob

For Existing Systems Only.*
6-Pin Only - No Cross Keying - Available in Z and DH Class Keyways Only.
Available UC or master keyed only. Not available KR or 0-bitted.

* L4, D1 and 60 keyway sections may be ordered Keyed Random only, without prior Key Systems Administration approval

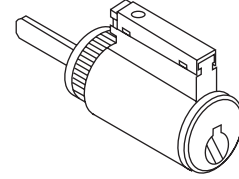

For Key-In-Lever/Knob Trim (.552" plug)

Cylinder Number	Series	Finish: 606, 626, BSP
CR2010-031	CL3100, CK4300	\$287.00
CR2010-033	CL3300, CL3500, CL3800 ^a , [CL3600 (June 2000 and after)]	
CR2010-034	CL3400, [CL3600 (prior to June 2000)], CLX3300	
CR2010-038	CL3800 ^a	
CR2010-039	CL3900	
CR2010-039L	CL3900 (2 - 2-1/4" door)	
CR2010-052	CK4200, UT5200	
CR2011-042	CK4229 Hotel Function*	\$305.00
CR2010-051	B2, G2 Exit Device Knob Trim	\$287.00
CR4410-134-A51	DL2200, DL3200 Cylindrical Deadlock	\$287.00
CR4410-134-A52	DL2200, DL3200 Cylindrical Deadlock	\$287.00
CR4410-214-A52	DL2200, DL3200 Cylindrical Deadlock	\$287.00

For uncombined cylinders suffix "UC" - See page 29 for deduct.
*Not available with 752, 852, or A Class Keyways.

Notes: A CL3800 manf. 1993-1997
B CL3800 manf. 2006 -

For Other Manufacturers' Products (.552" plug)

Cylinder Number	Series	Finish: 606, 626, BSP
2210-001-A21	Alarm Lock DL2500 Series	\$291.00
	Arrow® H Series Knobs and Levers	
	Arrow Q Series Levers	
	Sargent® 10 line*	
	Schlage® D Series Levers	
2210-001-A22	Schlage AL and ND Series Levers	
2210-002-A21	Schlage D Series Knobs	
2210-002-A23	Schlage A Series Knobs (ORB, only)	
2210-002-A22	Schlage A Series Knobs (PLY, ect)	
2210-003-A24	Lockwood® H Series Knobs (enlarge knob hole)	
2210-008	Sargent 7, 8, 9 Line (enlarge knob hole)	
2210-054	ASSA ABLOY ACCENTRA™ 5400, 6200 Knobs only (enlarge knob hole)	

* When ordered with a 30- prefix, this cylinder is accepted without modification to the lever.

*LFIC Cores are provided in 606 or 626 finish only.

IC Mortise

For Existing Systems Only.*
For Construction Core Program, see page 28. For housing only, see page 58-59.

6-Pin Only - No Cross Keying - Available in Z and DH Class Keyways Only.
Available UC or master keyed only. Not available KR or 0-bitted.

* L4, D1 and 60 keyway sections may be ordered Keyed Random only, without prior Key Systems Administration approval

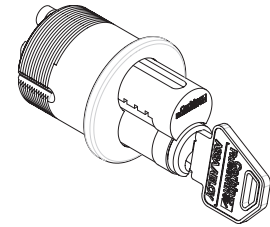

Cylinder Number Example

To simplify ordering, options designated "standard" may be omitted from the ordering sequence.

CR1090 - 114 - A01- L4

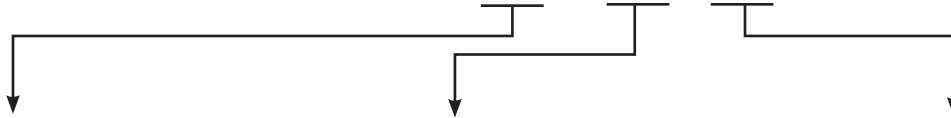

Length	Cam	Keyway
114 1-1/4" (standard)	A01 Cloverleaf (standard)	L4 (standard) Available only with Z and DH Class keyways.
138 1-3/8"	A02 Straight	
112 1-3/8"	A03 Adams Rite® MS & DL3000	
134 1-3/4"	A04 DL4000 Deadlock	
	A05 Adams Rite 4070	
	A06 ² Schlage® L9000	
	A07 DL4100 Series Deadlock	
	A62 Straight	
	A92 Exit Grip 01, 02	
	A93 ¹ For obsolete Corbin® 610 Series and Russwin® 1403 Series Deadlocks	

Cylinder Number	605, 606, 611, 612, 613, 613E, 618, 619, 622, 625, 626, 629, 630, 722, BSP, WSP
CR1090-114-	\$409.00
CR1090-138-	\$412.00
CR1090-112-	\$420.00
CR1090-134-	

- Notes:
1. Add \$2.00 per cylinder for A93 Cam.
2. Add \$5.00 per cylinder for A06 Cam.

Hotel Function IC Mortise

Cylinder Number	605, 606, 611, 612, 613, 613E, 618, 619, 622, 625, 626, 629, 630, 722, BSP, WSP
CR1091-138-A01 Hotel function uses - E1 suffix EMK blank	\$427.00

To simplify ordering, you may specify only "1091" since no length or cam variations exist.

*LFIC Cores are provided in 606 or 626 finish only.

IC Rim

For Existing Systems Only.*
 For Construction Core Program, see page 28.
 For housing only, see page 58-59.
 6-Pin Only - No Cross Keying - Available in Z and DH Class Keyways Only. Available UC or master keyed only. Not available 0-bitted.
 * L4, D1 and 60 keyway sections may be ordered Keyed Random only, without prior Key Systems Administration approval

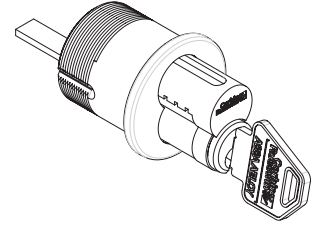

Cylinder Number Example

To simplify ordering, options designated "standard" may be omitted from the ordering sequence.

CR3090 - 178 - L4

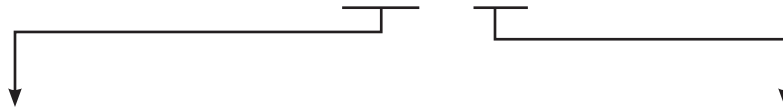

Tailpiece Length		Keyway
058	5/8" Tailpiece	L4 (standard). Available only with Z and DH Class keyways.
178	1-7/8" (standard)	
178V	1-7/8"(standard) vertical	
318	3-1/8" (thick door)	
114	1-1/4" for M61 and M62 option alarmed exit devices	

Cylinder Number	605, 606, 611, 612, 613, 613E, 618, 619, 622, 625, 626, 629, 630, 722, BSP, WSP
CR3090-058	\$409.00
CR3090-178	
CR3090-178V	
CR3090-318	
CR3090-114 No back plate or screws	

Security Core Only

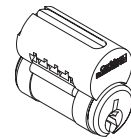

Cylinder Number	606, 626, BSP
CR8010 6-pin standard	\$279.00
CR8010EMK 6-pin standard set to hotel mortise EMK	
CR8011-042 6-pin for CK4229, hotel indicator pin	

For uncombined cores, suffix "UC," see page 29 for deduct.

Standard Master Ring Mortise

Cylinder Number Example

To simplify ordering, options designated "standard" may be omitted from the ordering sequence.

CR1060 - 118 - A61 - 6 - L4

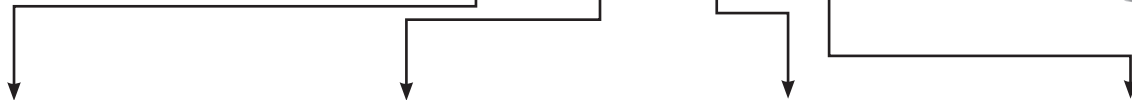

Length	Cam	Pins	Keyway
100 1" (5-pin only)	A61 New Cloverleaf (standard) (for locks made after 5/93; requires thumbturn hub 562F41-2)	5	L4 (standard)
118 1-1/8" (std)	A62 Straight	6 (standard)	
114 1-1/4"	A63* Large Short	7 (optional for 1-3/8" only)	
138 1-3/8"	A64* Large Long		
134 1-3/4"	A65* Old Cloverleaf (formerly 11A)		
112 1-1/2"			
200 2"			
214 2-1/4"			
212 2-1/2"			
234 2-3/4"			
300 3"			

Cylinder Number	605, 606, 611, 612, 613, 613E, 618, 619, 622, 625, 626, 722, BSP, WSP
CR1060-100-__-5	\$202.00
CR1060-118-__-__	
CR1060-114-__-__	
CR1060-138-__-__	
CR1060-112-__-__	\$212.00
CR1060-134-__-__	
CR1060-200-__-__	
CR1060-214-__-__	
CR1060-212-__-__	\$222.00
CR1060-234-__-__	
CR1060-300-__-__	

*Add \$2.00 per cylinder for A63, A64 and A65 Cam.

Flexible Head Master Ring Mortise

Cylinder Number Example

To simplify ordering, options designated "standard" may be omitted from the ordering sequence.

CR1160 - 118 - A61 - 6 - L4

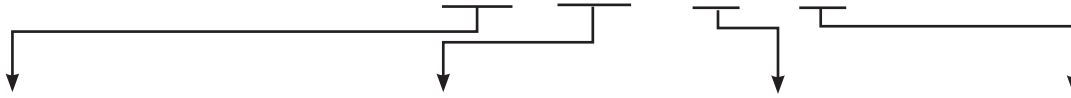

Length	Cam	Pins	Keyway
100 1" (6-pin std)	A61 New Cloverleaf (standard) (for locks made after 5/93; requires thumbturn hub 562F41-2)	5	L4 (standard)
118 1-1/8"		6 (standard)	
114 1-1/4"			
	A62 Straight		
	A63* Large Short		
	A64* Large Long		
	A65* Old Cloverleaf (formerly 11A)		

Cylinder Number	605, 606, 611, 612, 613, 613E, 618, 619, 622, 625, 626, 722, BSP, WSP
CR1160-100-__-__	\$249.00
CR1160-118-__-__	
CR1160-114-__-__	

* Add \$2.00 per cylinder for A63, A64 or A65 Cam.

Dummy Master Ring Mortise Cylinders

Cylinder Number	605, 606, 611, 612, 613, 613E, 618, 619, 622, 625, 626, 722, BSP, WSP
CR1460-118	\$192.00
CR1460-114	
CR1460-138	
CR1460-112	

Master Ring Rim

Cylinder Number (Specify Keyway)	F605, 606, 611, 612, 613, 613E, 618, 619, 622, 625, 626, 722, BSP, WSP
CR3060-200 Standard horizontal tailpiece	\$202.00
CR3060-312 Thick door, horizontal tailpiece	
CR3060-200V Vertical tailpiece	
CR3060-312V Thick door, vertical tailpiece	

For CK4200 & UT5200 Series Locksets (.552" dia. plug)

Cylinder Number	Finish: 606, 626, BSP
CR2060-052 Standard	\$168.00
CR2061-042* CK4229 Hotel with indicator pin	\$200.00
CR2160-052** Discontinued Ronde and Continental Knob	\$180.00

* Not Available with 752, 852 or A Class keyways.
 ** Also Available in 605, 611, 612, 613, 625 finishes.
 Not Available with X Class and certain restricted keyways.

Master Ring Special Applications For Exit Device Operators (.552" plug)

Cylinder Number	Finish: 606, 626, BSP
CR4266-001-A02 ED6800 x B5 or B6 trim ED7400 x 03 or 04 trim	\$186.00
CR4266-001-A92 ED6800 x 01 or 02 trim	

Pin Kits

Description	Catalog Number	Part Number	Price
Corbin Russwin System 70 and Pre-System 70, 752, 852 and A Class keyways Not for System 70 Security	PK-1070	610F538	\$1,373.00
Corbin® Z Class and Russwin® DH Class keyways System 70, all cylinders except Security	PK-70-ZDH	602F129	\$915.00
Russwin N Class System, all cylinders	PK-70-N	602F119	\$714.00
Corbin X Class, all cylinders	PK-70-X	602F109	\$699.00
Pyramid High Security cylinders	PK-20-HS	694F968	\$1,883.00
Pyramid Security cylinders	PK-20-PS	715F968	\$1,392.00
Security cylinders, including interchangeable core, blackout and Brink	PK-70-HS	610F529	\$2,597.00
Access 3 Key System AP only	PK-30-AP	763F088	\$1,340.00
Access 3 Key System - AP, AS, AHS	PK-30-MASTER	763F098	\$1,950.00

Tools

Description	Catalog Number	Part Number	Price
Tool kit - contains 1 each: CT-4, CT-11, CT-19, CT-21, CT-22, CT-23, CT-54	CT-93	612F588	\$353.00
Plug follower, .509" brass	CT-4	073F992	\$44.00
Pin chamber reamer	CT-5	239F758	\$124.00
Pin chamber burring tool	CT-7	382F188	\$327.00
Loading tool for .509" shell	CT-10	577F499	\$124.00
Key gauge, all Corbin® key classes	CT-11	239F377	\$44.00
Tweezers (was CT-6)	CT-19	239F368	\$52.00
Plug follower, .496	CT-20	694F972	\$14 (order in mult. of 10)
Key gauge, Pyramid	CT-20K	698F367	\$44.00
Key gauge, Access 3	CT-30K		
Key gauge, Russwin® N	CT-21	603F277	
Key gauge, Russwin® D & H	CT-22	604F197	
Key gauge, Russwin® 981/852	CT-23	604F187	
Plug follower, .552" brass	CT-54	073F982	\$53.00
IC mortise cylinder installation wrench	CT-80	363F612	\$76.00
Follower, disposable, .509" plug		484F729	\$1.00 (order in mult. Of 50)
Follower, disposable, .552" plug		484F739	\$0.50 (order in mult. Of 100)

Blank Page

ML2000 Series:

MicroShield®	72
ML2000 Series	73

ML2000 Museo Series:

ML2000 Series: Museo Georgia, Jackson, Salvador, Marc Levers, Inspire Trim	74
ML2000 Series: Museo Georgia, Jackson, Laszlo, Salvador, Marc, Josef Levers, Roses & Thumbturns	75
ML2000 Series: Museo Josef, Georges Levers, Roses & Thumbturns	76
ML2000 Series: Museo Piet Levers, Roses & Thumbturns	77
ML2000 Series: Museo Piet Levers, Roses & Thumbturns	78
ML2000 Series: Museo Georgia, Jackson, Laszlo, Salvador, Marc, Josef Levers & Escutcheons	79
ML2000 Series: Museo Josef, Georges Levers & Escutcheons	80
ML2000 Series: Museo Piet Levers & Escutcheons	81
ML2000 Series: Museo Piet Levers & Escutcheons	82

ML2000 Series:

ML2000 Series: LWA, RWA, LWN, LWM, LWP, LWR, LWVN	83
ML2000 Series: LSA, LSN, LSM, LSP, LSR, LSVN	84
ML2000 Series: ASA, CSA, NSA, PSA, RSA, NSM, NSN, NSP, NSR, NSVN	85
ML2000 Series: DSA, ESA, DSM, DSN, DSP, DSR, DSVN	86
ML2000 Series: GZA, GZB, GZF, GZH, YZA, YZB, YZF, YZH, GZM, GZP, GZR, GZVN	87
ML2000 Series Vineyard Collection: FSG, MSG, ZSG, FSL, MSL, ZSL, FSVN, MSVN, ZSVN	88
ML2000 Series: Deadbolts: M, N, P, L, R, VN	89
Vandal Resistant Trim: CSV, NSV	90

ML20900 Muséo Series:

ML20900 Series: Muséo Georgia, Jackson, Salvador, Marc Levers & Roses	91
ML20900 Series: Muséo Georgia, Jackson, Salvador, Laszlo, Marc, Josef Levers, Escutcheons, Roses and Thumbturns	92
ML20900 Series: Muséo Piet Levers, Escutcheons, Roses and Thumbturns	93
ML20900 Series: Muséo Piet Levers, Escutcheons, Roses and Thumbturns	94
ML20900 Series: Muséo Josef, Georges Levers, Escutcheons, Roses and Thumbturns	95

ML20900 Series:

ML20900 Series: LWA, RWA, LWM, LWN, LWR, ASA, CSA, LSA, NSA, PSA, RSA, NSM, NSN, NSR	96
ML20900 Series: DSA, ESA, DSM, DSN, DSR, CSV, NSV	97
ML20900 Series Vineyard Collection: FSG, MSG, ZSG, FSL, MSL, ZSL	98
ML20900 Series: GZA, GZB, GZF, GZH, YZA, YZB, YZF, YZH, GZM, GZP, GZR	99

ML20600 NAC Muséo Series:

ML20600 NAC Series: Muséo Georgia, Jackson, Salvador, Marc Levers with High Security Monitoring	100
ML20600 NAC Series: Muséo Georgia, Jackson, Salvador, Laszlo, Marc, Josef Levers & Roses with High Security Monitoring	101
ML20600 NAC Series: Muséo Piet Levers & Roses with High Security Monitoring	102
ML20600 NAC Series: Muséo Piet Levers & Roses with High Security Monitoring	103
ML20600 NAC Series: Muséo Josef, Georges Levers & Roses	104

ML20600 NAC Series:

ML20600 Series NAC: LWA, RWA, LWM, LWN, LWR, LWVN, ASA, CSA, LSA, NSA, PSA, RSA, NSM, NSN, NSR, NSVN	105
ML20600 Series NAC: DSA, ESA, DSM, DSN, DSR, DSVN, CSV, NSV	106
ML20600 Series NAC: Electrified Mortise with High Security Options: FSG, MSG, ZSG, FSL, MSL, ZSL, FSVN, MSVN, ZSVN	107

ML2000 Series:

ML2000 Series Electrically Controlled Mortise Locksets	108
ML2000 Series Ordering Lock Only	109
ML2000 Series Cylinder & Keying Options	110
ML2000 Series Cylinder & Keying Options (Continued), ML2000 Strike Options	111
ML2000 Series Door Thickness with Locksets Mortised on Center, Panel Applications	112
ML2000 Series Miscellaneous Options, Thumbturn Options	113
ML2000 Series Indicator Options, Sectional Trim Retrofit Kits for V Series Indicators	114

MicroShield®

Look for the *MicroShield* icon.

MicroShield®

As part of their promise to provide innovative solutions to their customers, certain ASSA ABLOY Group brands offer the MicroShield® technology, a silver-based antimicrobial coating designed to inhibit the growth of bacteria.

MicroShield® is a registered trademark of ASSA ABLOY Access and Egress Hardware Group, Inc.

Product	Series	MicroShield® Coated Components
Mortise Locks	ML2000 Series	Knobs/Levers, roses and/or escutcheons

AVAILABLE FINISHES

- MicroShield® is available on 626 and 630. Other finishes available by Special Product Application Request Form only.
- Specify 626C (satin chrome plated) or 630C (satin stainless steel) when ordering.
- MicroShield® coating will be applied over 626 and 630 finishes. All components will match 626.

Note: MicroShield® coating will only be applied to "high touch" components.

HOW TO ORDER

Product	How to Order
Mortise Locks	ML2055 x LWA x 626C x RHR

Description	Add
Mortise Locks	Add \$99.00

**Standard Features
Handing**

Field reversible

Door Thickness

1-3/4"

Backset

2-3/4"

Warranty

10 Years

Strike

ANSI straight lip
4-7/8" x 1-1/4" x 1-1/8" lip to center

Cylinder

Brass, 6-pin, L4 keyway, 0-bitted

Keys

Two nickel silver keys

Case Quantity

6

Case Weight

Variable

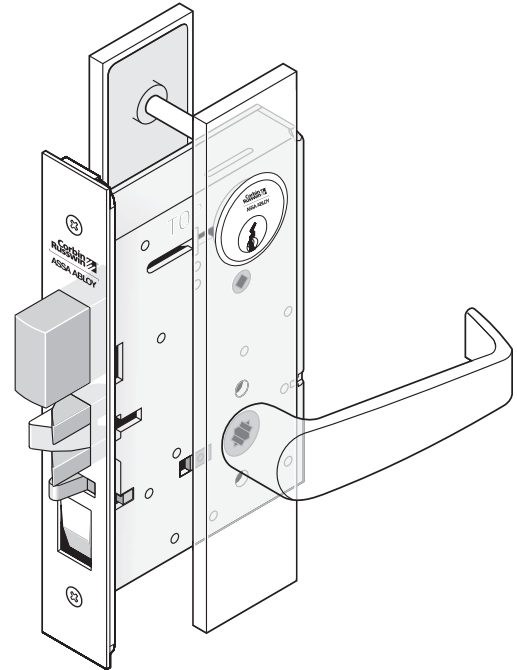

Please refer to the ML2000 Series catalog for more information.

Ordering Example:

Stock Order

Quantity	Series/Function	Trim	Finish	Hand
100	ML2055	LSB	626	RHR

Split Trim/Split Finish

Quantity	Series/Function	Trim		Finish		Hand
		Outside	Inside	Outside	Inside	
12	ML2055	LSB	NSB	626	625	RHR

Split trim is not available mixing escutcheon with sectional trim or with a different escutcheon

Contract/Detailed Order

Quantity	Keyset	Series/Function	Trim	Finish	Hand	Strike	Misc. Options	Cylinder and Keying
24	AA1	ML2055	LSB	626	RHR	SA200	M17-M26	C7-VKC3

Working Trim Only

Quantity	Function only	Trim	Finish	Hand	Door Thickness	Misc. Options
6	ML2055	LWA	626	RHR	D214	M31

(includes grip and spindle, rose or escutcheon, thumbturn, adapters and screws)

High Security Monitoring Option Order

Quantity	Series/Function	Technology Code	Trim	Finish	Hand	Fail Safe/ Fail Secure	High Security Monitoring Options
24	ML20608	NAC	ASA	626	RHR	SEC	PHRR01

Mortise Locksets

ML2000 Series: Muséo Levers and Inspire™ Roseless Trim

USA & Canada Prices Effective March 3, 2025



contemporary trim to complement the interior design of your next project

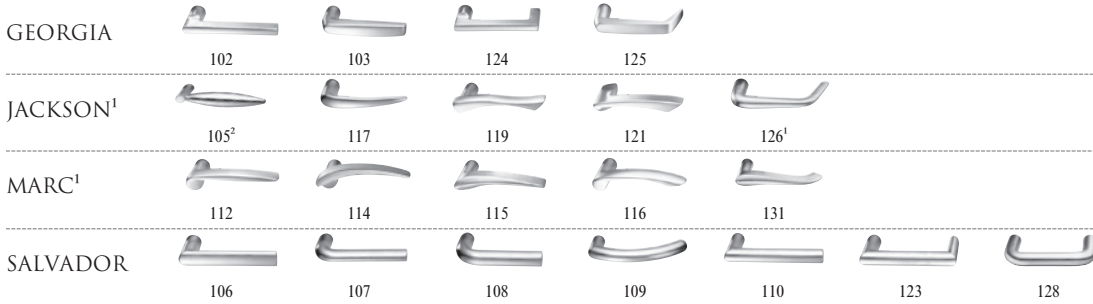

J Collar

¹Handed: specify hand when ordering.
²Contact factory for current lead time.

*629 and *630 finish options are Not available for all Muséo levers. Please refer to page 22 for availability.

613E	Dark Oxidized Satin Bronze - Equivalent	605	Bright Brass, Clear Coated	618	Bright Nickel Plated
626	Satin Chromium Plated	606	Satin Brass, Clear Coated	619	Satin Nickel Plated
BSP	Black Suede Powder Coat	611	Bright Bronze, Clear Coated	625	Bright Chromium Plated
WSP	White Suede Powder Coat	612	Satin Bronze, Clear Coated	629*	Bright Stainless Steel
		613	Dark Oxidized Satin Bronze, Oil Rubbed	630*	Satin Stainless Steel
		613L	Dark Oxidized Satin Bronze, Clear Coated	722	Black Oxidized Bronze, Oil Rubbed

Function

Function	Model	Description	Price	Price
Non-Keyed	ML2010	Passage	\$1,420.00	\$1,444.00
	ML2020	Privacy	\$1,690.00	\$1,714.00
	ML2030	Privacy	\$1,559.00	\$1,583.00
	ML2050	Half Dummy	\$579.00	\$591.00
	ML2070	Full Dummy	\$1,158.00	\$1,182.00
	ML2080	Half Active Dummy Trim	\$896.00	\$908.00
	ML2090	Full Active Dummy Trim	\$1,474.00	\$1,498.00
Single Cylinder	ML2003	Classroom		
	ML2051	Office		
	ML2055	Classroom	\$1,756.00	\$1,780.00
	ML2056	Classroom Holdback		
	ML2057	Storeroom		
	ML2069	Institution Privacy		
	ML2004	Classroom		
Single Cylinder with Deadbolt	ML2053	Entrance	\$1,778.00	\$1,802.00
	ML2054	Entrance		
	ML2058	Entrance Holdback		
	ML2068	Privacy or Classroom		
	ML2024	Entrance		
	ML2048	Entrance		
	ML2049	Storeroom Deadbolt		
Double Cylinder	ML2059	Security Storeroom	\$1,820.00	\$1,844.00
	ML2065	Dormitory		
	ML2067	Apartment		
	ML2073	Classroom Security		
	ML2075	Entrance/Office		
	ML2029	Hotel	\$1,908.00	\$1,932.00
	ML2002	Classroom Intruder		
Double Cylinder with Deadbolt	ML2032	Institution	\$1,886.00	\$1,910.00
	ML2042	Entrance		
	ML2052	Classroom Intruder		
	ML2087	Security Vestibule		
Double Cylinder with Deadbolt	ML2022	Store Door	\$1,950.00	\$1,974.00
	ML2062	Intruder Deadbolt		
	ML2072	Classroom Security Intruder		
	ML2082	Dormitory		
ML2092	Security Institution			
Full Working Trim (Quick Code M31) No cylinder; includes thumbturn lever			\$1,217.00	\$1,241.00

Ordering Example Details

ML2000	ML2051	Office Function
Sectional Trim	102	Georgia Family Lever
(rose)	J	Collar
	625	Finish
	RHR	Handing



Stock Order

Quantity	Series/Function	Trim	Finish	Hand
24	ML2051	102J	625	RHR



Experience a safer and more open world

Mortise Locksets

ML2000 Series: Muséo Levers, Roses and Thumbturns

USA & Canada Prices Effective March 3, 2025

contemporary levers to complement the interior design of your next project

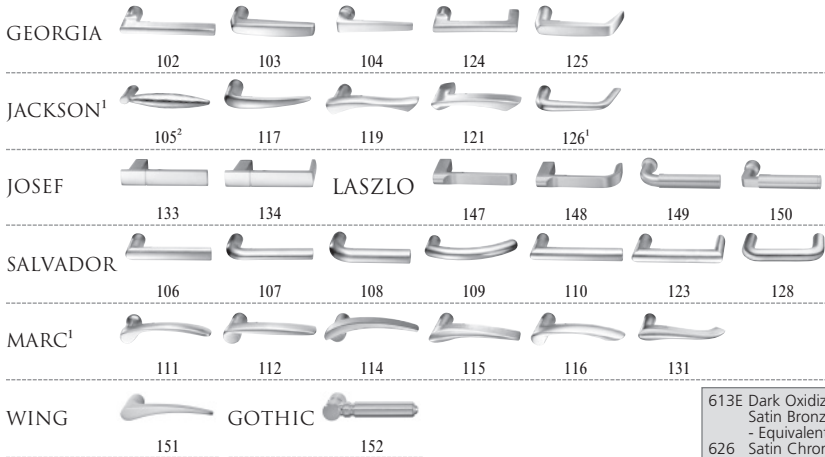

ROSES

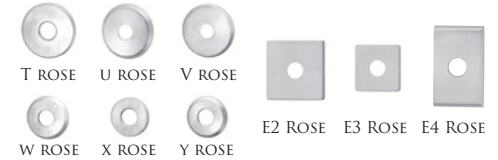

THUMBTURNS³



1. Handed: specify hand when ordering
2. Contact factory for current lead time
3. Specify thumbturn as quick code. Thumbturn backplate will match shape of rose chosen (i.e. round or square)

*629 and *630 finish options are Not available for all Muséo levers. Please refer to page 22 for availability.

613E	Dark Oxidized Satin Bronze - Equivalent	605	Bright Brass, Clear Coated	618	Bright Nickel Plated
626	Satin Chromium Plated	606	Satin Brass, Clear Coated	619	Satin Nickel Plated
BSP	Black Suede Powder Coat	611	Bright Bronze, Clear Coated	625	Bright Chromium Plated
WSP	White Suede Powder Coat	612	Satin Bronze, Clear Coated	629*	Bright Stainless Steel
		613	Dark Oxidized Satin Bronze, Oil Rubbed	630*	Satin Stainless Steel
		613L	Dark Oxidized Satin Bronze, Clear Coated	722	Black Oxidized Bronze, Oil Rubbed

Function

Function	Model	Description	Price	Price		
Non-Keyed	ML2010	Passage	\$1,191.00	\$1,215.00		
	ML2020	Privacy	\$1,436.00	\$1,460.00		
	ML2030					
	ML2040	Passage w/Indicator – VXX Option on Page 114 Applies	\$1,401.00	\$1,425.00		
	ML2060	Privacy				
	ML2050	Half Dummy	\$490.00	\$502.00		
	ML2070	Full Dummy	\$980.00	\$1,004.00		
	ML2080	Half Active Dummy Trim	\$745.00	\$757.00		
ML2090	Full Active Dummy Trim	\$1,273.00	\$1,297.00			
Single Cylinder	ML2003	Classroom	\$1,502.00	\$1,526.00		
	ML2051	Office				
	ML2055	Classroom				
	ML2056	Classroom Holdback				
	ML2057	Storeroom				
	ML2069	Institution Privacy				
	ML2004	Classroom			\$1,524.00	\$1,548.00
	ML2053	Entrance				
ML2054	Entrance					
ML2058	Entrance Holdback					
ML2068	Privacy or Classroom					
Single Cylinder with Deadbolt	ML2024	Entrance	\$1,566.00	\$1,590.00		
	ML2048	Entrance				
	ML2049	Storeroom Deadbolt				
	ML2059	Security Storeroom				
	ML2065	Dormitory				
	ML2067	Apartment				
	ML2073	Classroom Security				
	ML2075	Entrance/Office				
ML2029	Hotel	\$1,615.00	\$1,639.00			
Double Cylinder	ML2002	Classroom Intruder	\$1,632.00	\$1,656.00		
	ML2032	Institution				
	ML2042	Entrance				
	ML2052	Classroom Intruder				
	ML2087	Security Vestibule				
Double Cylinder with Deadbolt	ML2022	Store Door	\$1,696.00	\$1,720.00		
	ML2062	Intruder Deadbolt				
	ML2072	Classroom Security Intruder				
	ML2082	Dormitory				
	ML2092	Security Institution				
Full Working Trim (Quick Code M31) No cylinder; includes thumbturn lever			\$1,099.00	\$1,123.00		

Ordering Example Details

ML2000	ML2051	Office Function
Sectional Trim	111	Marc Family Lever
(rose)	W	Rose
	625	Finish
	RHR	Handing

Stock Order

Quantity	Series/Function	Trim	Finish	Hand
24	ML2051	111W	625	RHR



Experience a safer and more open world

Copyright © 2002-2025 Corbin Russwin, Inc., an ASSA ABLOY Group company. All rights reserved. Reproduction in whole or in part without the express written permission of Corbin Russwin, Inc., is prohibited. Contact us at: 800-543-3658 or visit www.corbinrusswin.com. In Canada contact us at: 800-461-3007 or visit www.assaabloydss.ca

Mortise Locksets

ML2000 Series: Muséo Levers, Roses and Thumbturns

USA & Canada Prices Effective March 3, 2025

contemporary levers to complement the interior design of your next project



JOSEF



GEORGES



ROSES

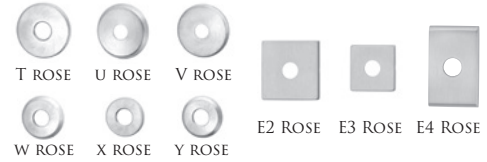

THUMBTURNS³



1. Handed: specify hand when ordering
2. Contact factory for current lead time
3. Specify thumbturn as quick code. Thumbturn backplate will match shape of rose chosen (i.e. round or square)

Function

613E	Dark Oxidized Satin Bronze - Equivalent	605	Bright Brass, Clear Coated	618	Bright Nickel Plated
626	Satin Chromium Plated	606	Satin Brass, Clear Coated	609	Satin Nickel Plated
BSP	Black Suede Powder Coat	611	Bright Bronze, Clear Coated	625	Bright Chromium Plated
WSP	White Suede Powder Coat	612	Satin Bronze, Clear Coated	629	Bright Stainless Steel
		613	Dark Oxidized Satin Bronze, Oil Rubbed	630	Satin Stainless Steel
		613L	Dark Oxidized Satin Bronze, Clear Coated	722	Black Oxidized Bronze, Oil Rubbed

Function	Model	Description	Price	Price		
Non-Keyed	ML2010	Passage	\$1,496.00	\$1,520.00		
	ML2020	Privacy	\$1,719.00	\$1,743.00		
	ML2030					
	ML2040	Passage w/Indicator – VXX Option on Page 114 Applies	\$1,684.00	\$1,708.00		
	ML2060	Privacy				
	ML2050	Half Dummy	\$641.00	\$653.00		
	ML2070	Full Dummy	\$1,282.00	\$1,306.00		
	ML2080	Half Active Dummy Trim	\$997.00	\$1,009.00		
ML2090	Full Active Dummy Trim	\$1,496.00	\$1,520.00			
Single Cylinder	ML2003	Classroom	\$1,785.00	\$1,809.00		
	ML2051	Office				
	ML2055	Classroom				
	ML2056	Classroom Holdback				
	ML2057	Storeroom				
	ML2069	Institution Privacy				
	ML2004	Classroom			\$1,807.00	\$1,831.00
	ML2053	Entrance				
ML2054	Entrance					
ML2058	Entrance Holdback					
ML2068	Privacy or Classroom					
Single Cylinder with Deadbolt	ML2024	Entrance	\$1,849.00	\$1,873.00		
	ML2048	Entrance				
	ML2049	Storeroom Deadbolt				
	ML2059	Security Storeroom				
	ML2065	Dormitory				
	ML2067	Apartment				
	ML2073	Classroom Security				
ML2075	Entrance/Office					
ML2029	Hotel	\$1,898.00	\$1,922.00			
Double Cylinder	ML2002	Classroom Intruder	\$1,915.00	\$1,939.00		
	ML2032	Institution				
	ML2042	Entrance				
	ML2052	Classroom Intruder				
	ML2087	Security Vestibule				
Double Cylinder with Deadbolt	ML2022	Store Door	\$1,979.00	\$2,003.00		
	ML2062	Intruder Deadbolt				
	ML2072	Classroom Security Intruder				
	ML2082	Dormitory				
	ML2092	Security Institution				
Full Working Trim (Quick Code M31) No cylinder; includes thumbturn lever			\$1,320.00	\$1,344.00		

Ordering Example Details

ML2000	ML2051	Office Function
Sectional Trim (rose)	135	Josef Family Lever
	E4	Rose
	625	Finish
	RHR	Handing



Stock Order

Quantity	Series/Function	Trim	Finish	Hand
24	ML2051	135E4	625	RHR



Experience a safer and more open world

Copyright © 2002-2025 Corbin Russwin, Inc., an ASSA ABLOY Group company. All rights reserved. Reproduction in whole or in part without the express written permission of Corbin Russwin, Inc., is prohibited. Contact us at: 800-543-3658 or visit www.corbinrusswin.com. In Canada contact us at: 800-461-3007 or visit www.assaabloydss.ca

Mortise Locksets

ML2000 Series: Muséo Levers, Roses and Thumbturns

USA & Canada Prices Effective March 3, 2025



contemporary trim to complement the interior design of your next project



*613E, BSP, WSP finishes are not available with 21M levers

ROSES

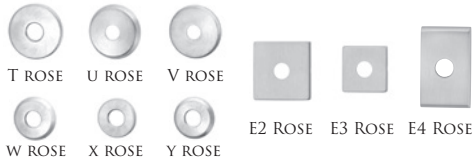

613E	Dark Oxidized Satin Bronze – Equivalent
629	Bright Stainless Steel
630	Satin Stainless Steel
BSP	Black Suede Powder Coat
WSP	White Suede Powder Coat

THUMBTURN



Specify thumbturn as quick code. Thumbturn backplate will match shape of rose chosen (i.e. round or square).

Function

Non-Keyed	ML2010	Passage	\$1,408.00
	ML2020	Privacy	\$1,621.00
	ML2030		
	ML2040	Passage w/Indicator – VXX Option on Page 114 Applies	\$1,583.00
	ML2060	Privacy	
	ML2050	Half Dummy	\$601.00
	ML2070	Full Dummy	\$1,202.00
	ML2080	Half Active Dummy Trim	\$938.00
ML2090	Full Active Dummy Trim	\$1,408.00	
Single Cylinder	ML2003	Classroom	\$1,687.00
	ML2051	Office	
	ML2055	Classroom	
	ML2056	Classroom Holdback	
	ML2057	Storeroom	\$1,709.00
	ML2069	Institution Privacy	
	ML2004	Classroom	
	ML2053	Entrance	
ML2054	Entrance	\$1,751.00	
ML2058	Entrance Holdback		
ML2068	Privacy or Classroom		
ML2024	Entrance		\$1,799.00
ML2048	Entrance		
ML2049	Storeroom Deadbolt		
ML2059	Security Storeroom		
ML2065	Dormitory		
ML2067	Apartment		
ML2073	Classroom Security		
ML2075	Entrance/Office		
ML2029	Hotel	\$1,817.00	
ML2002	Classroom Intruder		
ML2032	Institution		
ML2042	Entrance		
ML2052	Classroom Intruder		
ML2087	Security Vestibule	\$1,881.00	
ML2022	Store Door		
ML2062	Intruder Deadbolt		
ML2072	Classroom Security Intruder		
ML2082	Dormitory		
ML2092	Security Institution	\$1,240.00	
Full Working Trim (Quick Code M31) No cylinder; includes thumbturn lever			\$1,240.00

Ordering Example Details

ML2000 Sectional Trim (rose)	ML2051	Office Function
	21M V 293029	Piet Family Lever - Polished with Satin Insert Rose Lever Finish Polished with satin stainless steel insert (630), polished stainless steel (629) shank and polished stainless steel (629) grip
	629 RHR	Lock Finish Handing

Stock Order					
Quantity	Series/Function	Trim	Lever Finish	Lock Finish	Hand
2	ML2051	21MV	293029	629	RHR



ASSA ABLOY



Experience a safer and more open world

Mortise Locksets

ML2000 Series: Muséo Levers, Roses and Thumbturns

USA & Canada Prices Effective March 3, 2025

contemporary levers to complement the interior design of your next project



PIET



ROSES

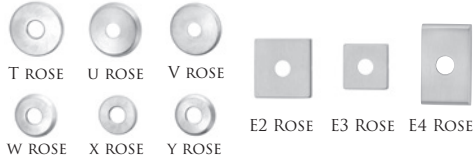

THUMBTURNS



Specify thumbturn as quick code. Thumbturn backplate will match shape of rose chosen (i.e. round or square)

613E	Dark Oxidized Satin Bronze – Equivalent
629	Bright Stainless Steel
630	Satin Stainless Steel
BSP	Black Suede Powder Coat
WSP	White Suede Powder Coat

Function

Function	Model	Description	Price
Non-Keyed	ML2010	Passage	\$1,520.00
	ML2020	Privacy	\$1,743.00
	ML2030		
	ML2040	Passage w/Indicator – VXX Option on Page 114 Applies	\$1,708.00
	ML2060	Privacy	
	ML2050	Half Dummy	\$653.00
	ML2070	Full Dummy	\$1,306.00
	ML2080	Half Active Dummy Trim	\$1,009.00
ML2090	Full Active Dummy Trim	\$1,520.00	
Single Cylinder	ML2003	Classroom	\$1,809.00
	ML2051	Office	
	ML2055	Classroom	
	ML2056	Classroom Holdback	
	ML2057	Storeroom	\$1,831.00
	ML2069	Institution Privacy	
	ML2004	Classroom	
	ML2053	Entrance	
ML2054	Entrance	\$1,873.00	
ML2058	Entrance Holdback		
ML2068	Privacy or Classroom		
ML2024	Entrance		\$1,922.00
ML2048	Entrance		
ML2049	Storeroom Deadbolt		
ML2059	Security Storeroom		
ML2065	Dormitory		
ML2067	Apartment		
ML2073	Classroom Security		
ML2075	Entrance/Office		
ML2029	Hotel	\$1,939.00	
ML2002	Classroom Intruder		
ML2032	Institution		
ML2042	Entrance		
ML2052	Classroom Intruder		
ML2087	Security Vestibule	\$2,003.00	
ML2022	Store Door		
ML2062	Intruder Deadbolt		
ML2072	Classroom Security Intruder		
ML2082	Dormitory		
ML2092	Security Institution	\$1,344.00	
Full Working Trim (Quick Code M31) No cylinder; includes thumbturn lever			

Ordering Example Details

ML2000	ML2051	Office Function
Sectional Trim	23M	Piet Family Lever - Wood Insert
(rose)	U	Rose
	29BH29	Lever Finish, Wood insert with polished stainless steel (629) shank and polished stainless steel (629) grip
	629	Lock Finish
	RHR	Handing

Stock Order					
Quantity	Series/Function	Trim	Lever Finish	Lock Finish	Hand
2	ML2051	23MU	29BH29	629	RHR



Experience a safer and more open world

Mortise Locksets

ML2000 Series: Muséo Levers and Escutcheons

USA & Canada Prices Effective March 3, 2025



contemporary levers to complement the interior design of your next project

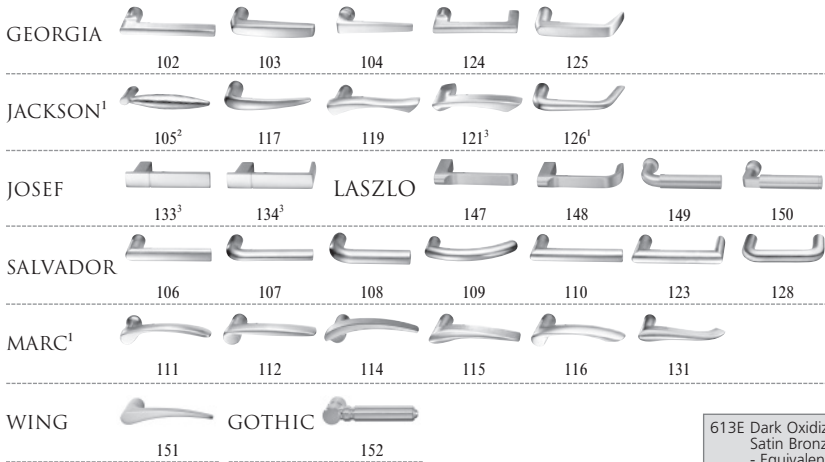

- 1. Handed: specify hand when ordering.
- 2. Contact factory for current lead time.
- 3. Not available with VN escutcheon.
- 4. VN escutcheon available only with indicators. Must be ordered with "V" indicator options. See page 114 for available functions. Option add also applies.

*629 and 630 finish options are Not available for all Muséo levers. Please refer to page 22 for availability.

613E	Dark Oxidized Satin Bronze - Equivalent	618	Bright Nickel Plated
626	Satin Chromium Plated	619	Satin Nickel Plated
BSP	Black Suede Powder Coat	625	Bright Chromium Plated
WSP	White Suede Powder Coat	629*	Bright Stainless Steel
605	Bright Brass, Clear Coated	630*	Satin Stainless Steel
606	Satin Brass, Clear Coated	722	Black Oxidized Bronze, Oil Rubbed
611	Bright Bronze, Clear Coated		
612	Satin Bronze, Clear Coated		
613	Dark Oxidized Satin Bronze, Oil Rubbed		
613L	Dark Oxidized Satin Bronze, Clear Coated		

Function

Function	Model	Description	Price (USA)	Price (Canada)
Non-Keyed	ML2010	Passage	\$1,245.00	\$1,269.00
	ML2020	Privacy	\$1,490.00	\$1,514.00
	ML2030			
	ML2040	Passage w/Indicator – VXX Option on Page 114 Applies	\$1,455.00	\$1,479.00
	ML2060	Privacy		
	ML2050	Half Dummy	\$517.00	\$529.00
	ML2070	Full Dummy	\$1,034.00	\$1,058.00
	ML2080	Half Active Dummy Trim	\$772.00	\$784.00
ML2090	Full Active Dummy Trim	\$1,327.00	\$1,351.00	
Single Cylinder	ML2003	Classroom	\$1,556.00	\$1,580.00
	ML2051	Office		
	ML2055	Classroom		
	ML2056	Classroom Holdback		
	ML2057	Storeroom	\$1,578.00	\$1,602.00
	ML2069	Institution Privacy		
	ML2004	Classroom		
	ML2053	Entrance		
ML2054	Entrance	\$1,620.00	\$1,644.00	
ML2058	Entrance Holdback			
ML2068	Privacy or Classroom			
ML2024	Entrance			
ML2048	Entrance	\$1,669.00	\$1,693.00	
ML2049	Storeroom Deadbolt			
ML2059	Security Storeroom			
ML2065	Dormitory			
Double Cylinder	ML2067	Apartment	\$1,686.00	\$1,710.00
	ML2073	Classroom Security		
	ML2075	Entrance/Office		
	ML2029	Hotel		
Double Cylinder with Deadbolt	ML2002	Classroom Intruder	\$1,750.00	\$1,774.00
	ML2032	Institution		
	ML2042	Entrance		
	ML2052	Classroom Intruder		
	ML2022	Store Door		
ML2062	Intruder Deadbolt	\$1,750.00	\$1,774.00	
ML2072	Classroom Security Intruder			
ML2082	Dormitory			
ML2092	Security Institution			
Full Working Trim (Quick Code M31) No cylinder; includes thumbturn lever			\$1,153.00	\$1,177.00

Ordering Example Details

ML2000	Office Function
Escutcheon Trim	Marc Family Lever
ML2051	Escutcheon
L	Finish
619	Handing
RHR	

Stock Order

Quantity	Series/Function	Trim	Finish	Hand
24	ML2051	111L	619	RHR



Experience a safer and more open world

Mortise Locksets

ML2000 Series: Muséo Levers and Escutcheons

USA & Canada Prices Effective March 3, 2025

contemporary levers to complement the interior design of your next project



JOSEF



GEORGES



1. Handed: specify hand when ordering.
2. Contact factory for current lead time.
3. Not available with escutcheon indicators.

613E Dark Oxidized Satin Bronze - Equivalent	605 Bright Brass, Clear Coated	618 Bright Nickel Plated
626 Satin Chromium Plated	606 Satin Brass, Clear Coated	619 Satin Nickel Plated
BSP Black Suede Powder Coat	611 Bright Bronze, Clear Coated	625 Bright Chromium Plated
WSP White Suede Powder Coat	612 Satin Bronze, Clear Coated	629 Bright Stainless Steel
	613 Dark Oxidized Satin Bronze, Oil Rubbed	630 Satin Stainless Steel
	613L Dark Oxidized Satin Bronze, Clear Coated	722 Black Oxidized Bronze, Oil Rubbed

Function

Function	Model	Description	Price (USA)	Price (Canada)
Non-Keyed	ML2010	Passage	\$1,569.00	\$1,593.00
	ML2020	Privacy	\$1,792.00	\$1,816.00
	ML2030	Passage w/Indicator – VXX Option on Page 114 Applies		
	ML2040	Privacy	\$1,757.00	\$1,781.00
	ML2050	Half Dummy	\$678.00	\$690.00
	ML2070	Full Dummy	\$1,355.00	\$1,379.00
	ML2080	Half Active Dummy Trim	\$1,034.00	\$1,046.00
	ML2090	Full Active Dummy Trim	\$1,569.00	\$1,593.00
Single Cylinder	ML2003	Classroom	\$1,858.00	\$1,882.00
	ML2051	Office		
	ML2055	Classroom		
	ML2056	Classroom Holdback		
	ML2057	Storeroom	\$1,880.00	\$1,904.00
	ML2069	Institution Privacy		
	ML2004	Classroom		
	ML2053	Entrance		
ML2054	Entrance	\$1,922.00	\$1,946.00	
ML2058	Entrance Holdback			
ML2068	Privacy or Classroom			
Single Cylinder with Deadbolt	ML2024	Entrance	\$1,971.00	\$1,995.00
	ML2048	Entrance		
	ML2049	Storeroom Deadbolt		
	ML2059	Security Storeroom		
	ML2065	Dormitory		
	ML2067	Apartment		
	ML2073	Classroom Security		
ML2075	Entrance/Office	\$2,052.00	\$2,076.00	
ML2029	Hotel			
ML2002	Classroom Intruder			
ML2032	Institution			
Double Cylinder	ML2042	Entrance	\$1,988.00	\$2,012.00
	ML2052	Classroom Intruder		
	ML2022	Store Door		
Double Cylinder with Deadbolt	ML2062	Intruder Deadbolt	\$2,052.00	\$2,076.00
	ML2072	Classroom Security Intruder		
	ML2082	Dormitory		
	ML2092	Security Institution		
	Full Working Trim (Quick Code M31) No cylinder; includes thumbturn lever			



Ordering Example Details

ML2000	ML2051	Office Function
Escutcheon Trim	135	Josef Family Lever
	L	Escutcheon
	619	Finish
	RHR	Handing

Stock Order

Quantity	Series/Function	Trim	Finish	Hand
24	ML2051	135L	619	RHR



Experience a safer and more open world

Mortise Locksets

ML2000 Series: Muséo Levers and Escutcheons

USA & Canada Prices Effective March 3, 2025

contemporary levers to complement the interior design of your next project



PIET

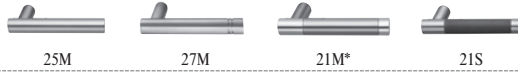

*613E, BSP, WSP finishes are not available with 21M levers.

- 1. VN escutcheon available only with indicators.
Must be ordered with "V" indicator options.
See page 114 for available functions.
Option add also applies.



613E	Dark Oxidized Satin Bronze – Equivalent
629	Bright Stainless Steel
630	Satin Stainless Steel
BSP	Black Suede Powder Coat
WSP	White Suede Powder Coat

Function

Non-Keypad	ML2010	Passage	\$1,481.00	
	ML2020	Privacy	\$1,694.00	
	ML2030			
	ML2040	Passage w/Indicator – VXX Option on Page 114 Applies	\$1,656.00	
	ML2060	Privacy		
	ML2050	Half Dummy	\$638.00	
	ML2070	Full Dummy	\$1,275.00	
	ML2080	Half Active Dummy Trim	\$975.00	
ML2090	Full Active Dummy Trim	\$1,481.00		
Single Cylinder	ML2003	Classroom	\$1,760.00	
	ML2051	Office		
	ML2055	Classroom		
	ML2056	Classroom Holdback		
	ML2057	Storeroom		
	ML2069	Institution Privacy		
	ML2004	Classroom		\$1,782.00
	ML2053	Entrance		
ML2054	Entrance			
ML2058	Entrance Holdback			
ML2068	Privacy or Classroom			
Single Cylinder with Deadbolt	ML2024	Entrance	\$1,824.00	
	ML2048	Entrance		
	ML2049	Storeroom Deadbolt		
	ML2059	Security Storeroom		
	ML2065	Dormitory		
	ML2067	Apartment		
	ML2073	Classroom Security		
	ML2075	Entrance/Office		
ML2029	Hotel	\$1,872.00		
Double Cylinder	ML2002	Classroom Intruder	\$1,890.00	
	ML2032	Institution		
	ML2042	Entrance		
	ML2052	Classroom Intruder		
Double Cylinder with Deadbolt	ML2022	Store Door	\$1,954.00	
	ML2062	Intruder Deadbolt		
	ML2072	Classroom Security Intruder		
	ML2082	Dormitory		
ML2092	Security Institution			
Full Working Trim (Quick Code M31) No cylinder; includes thumbturn lever			\$1,313.00	



Ordering Example Details

ML2000
Escutcheon
Trim

ML2051 Office Function
21M Piet Family Lever - Polished with Satin Insert
L Escutcheon
293029 Lever Finish
Polished with satin stainless steel insert (630),
polished stainless steel (629) shank and
polished stainless steel (629) grip
629 Lock Finish
RHR Handing

Stock Order

Quantity	Series/Function	Trim	Lever Finish	Lock Finish	Hand
2	ML2051	21ML	293029	629	RHR



ASSA ABLOY

Experience a safer
and more open world

Mortise Locksets

ML2000 Series: Muséo Levers and Escutcheons

USA & Canada Prices Effective March 3, 2025

contemporary levers to complement the interior design of your next project



PIET



23M

21G

21L



L ESCUTCHEON



R ESCUTCHEON



VN ESCUTCHEON

(See Note 1)

1. VN escutcheon available only with indicators. Must be ordered with "V" indicator options. See page 114 for available functions. Option add also applies.

613E	Dark Oxidized Satin Bronze – Equivalent
629	Bright Stainless Steel
630	Satin Stainless Steel
BSP	Black Suede Powder Coat
WSP	White Suede Powder Coat

Function

Non-Keypad	ML2010	Passage	\$1,593.00	
	ML2020	Privacy	\$1,816.00	
	ML2030			
	ML2040	Passage w/Indicator – VXX Option on Page 114 Applies	\$1,781.00	
	ML2060	Privacy		
	ML2050	Half Dummy	\$690.00	
	ML2070	Full Dummy	\$1,379.00	
	ML2080	Half Active Dummy Trim	\$1,046.00	
ML2090	Full Active Dummy Trim	\$1,593.00		
Single Cylinder	ML2003	Classroom	\$1,882.00	
	ML2051	Office		
	ML2055	Classroom		
	ML2056	Classroom Holdback		
	ML2057	Storeroom		
	ML2069	Institution Privacy		
	ML2004	Classroom		\$1,904.00
	ML2053	Entrance		
ML2054	Entrance			
ML2058	Entrance Holdback			
ML2068	Privacy or Classroom			
Single Cylinder with Deadbolt	ML2024	Entrance	\$1,946.00	
	ML2048	Entrance		
	ML2049	Storeroom Deadbolt		
	ML2059	Security Storeroom		
	ML2065	Dormitory		
	ML2067	Apartment		
	ML2073	Classroom Security		
	ML2075	Entrance/Office		
ML2029	Hotel	\$1,995.00		
Double Cylinder	ML2002	Classroom Intruder	\$2,012.00	
	ML2032	Institution		
	ML2042	Entrance		
	ML2052	Classroom Intruder		
Double Cylinder with Deadbolt	ML2022	Store Door	\$2,076.00	
	ML2062	Intruder Deadbolt		
	ML2072	Classroom Security Intruder		
	ML2082	Dormitory		
	ML2092	Security Institution		
Full Working Trim (Quick Code M31) No cylinder; includes thumbturn lever			\$1,417.00	



Ordering Example Details

ML2000

Escutcheon Trim

ML2051 Office Function
 23M Piet Family Lever - Wood Insert
 L Escutcheon
 29BH29 Lever Finish
 Wood insert with polished stainless steel (629) shank and polished stainless steel (629) grip
 629 Lock Finish
 RHR Handing

Stock Order

Quantity	Series/Function	Trim	Lever Finish	Lock Finish	Hand
2	ML2051	23M	29BH29	629	RHR



ASSA ABLOY

Experience a safer and more open world



LWA RWA
Lever: Wrought
Rose: Wrought

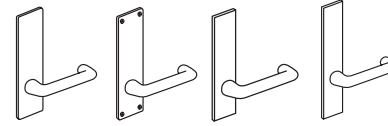

LWM LWN LWP LWR
Lever: Wrought
Escutcheon: Wrought

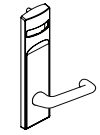

LWVN
Lever: Wrought
Esc: Solid Stainless
Escutcheon: Steel or Forged Brass Forged Brass

Levers: LW, RW Roses: A Roses: B, F (see note 1)	
613E, 626, BSP, WSP	605, 606, 611, 612, 613, 618, 619, 625, 629, 630, 722

Levers: LW, RW Escutcheons: M, N, P	
613E, 626, BSP, WSP	605, 606, 611, 612, 613, 618, 619, 625, 629, 630, 722

Levers: LW, RW Escutcheons: R (see note 2) VN (see note 3)	
613E, 626, BSP, WSP	605, 606, 611, 612, 613, 618, 619, 625, 629, 630, 722

Function		613E, 626, BSP, WSP	605, 606, 611, 612, 613, 618, 619, 625, 629, 630, 722	613E, 626, BSP, WSP	605, 606, 611, 612, 613, 618, 619, 625, 629, 630, 722	613E, 626, BSP, WSP	605, 606, 611, 612, 613, 618, 619, 625, 629, 630, 722
Non-Keyed	ML2010 Passage	\$942.00	\$966.00	\$962.00	\$986.00	\$1,016.00	\$1,040.00
	ML2020 Privacy	\$1,129.00	\$1,153.00	\$1,149.00	\$1,173.00	\$1,203.00	\$1,227.00
	ML2030 Privacy						
	ML2040 Passage w/Indicator – VXX Option on Page 114 Applies	\$1,102.00	\$1,126.00	\$1,122.00	\$1,146.00	\$1,176.00	\$1,200.00
	ML2060 Privacy						
	ML2050 Half Dummy	\$451.00	\$463.00	\$461.00	\$473.00	\$488.00	\$500.00
	ML2070 Full Dummy	\$902.00	\$926.00	\$922.00	\$946.00	\$976.00	\$1,000.00
	ML2080 Half Active Dummy Trim	\$555.00	\$567.00	\$565.00	\$577.00	\$592.00	\$604.00
ML2090 Full Active Dummy Trim	\$957.00	\$981.00	\$977.00	\$1,001.00	\$1,031.00	\$1,055.00	
Single Cylinder	ML2003 Classroom						
	ML2051 Office						
	ML2055 Classroom	\$1,195.00	\$1,219.00	\$1,215.00	\$1,239.00	\$1,269.00	\$1,293.00
	ML2056 Classroom						
	ML2057 Storeroom						
	ML2069 Institution Privacy						
	ML2004 Classroom						
	ML2053 Entrance	\$1,217.00	\$1,241.00	\$1,237.00	\$1,261.00	\$1,291.00	\$1,315.00
ML2054 Entrance							
ML2058 Entrance Holdback							
ML2068 Privacy or Apartment							
Single Cylinder with Deadbolt	ML2024 Entrance						
	ML2048 Entrance						
	ML2049 Storeroom Deadbolt						
	ML2065 Dormitory	\$1,259.00	\$1,283.00	\$1,279.00	\$1,303.00	\$1,333.00	\$1,357.00
	ML2059 Security Storeroom						
	ML2067 Apartment						
	ML2073 Classroom Security						
ML2075 Entrance/Office							
ML2029 Hotel	\$1,309.00	\$1,333.00	\$1,329.00	\$1,353.00	\$1,383.00	\$1,407.00	
Double Cylinder	ML2002 Classroom Intruder						
	ML2032 Institution						
	ML2042 Entrance	\$1,325.00	\$1,349.00	\$1,345.00	\$1,369.00	\$1,399.00	\$1,423.00
	ML2052 Classroom Intruder						
	ML2087 Security Vestibule					N/A	N/A
Double Cylinder with Deadbolt	ML2022 Store Door						
	ML2062 Intruder Deadbolt						
	ML2072 Classroom Security Intruder	\$1,389.00	\$1,413.00	\$1,409.00	\$1,433.00	\$1,463.00	\$1,487.00
	ML2082 Dormitory						
ML2092 Security Institution							
Full Working Trim (Quick Code M31) No cylinder; includes thumbturn lever	\$843.00	\$867.00	\$863.00	\$887.00	\$917.00	\$941.00	

NOTES: 1. Rose substitutions for LWA, RWA: 2-1/4" cast rose in place of 2-1/4" wrought rose, substitute letter "B" in place of "A" (e.g. LWB). **Add \$57.00 per lockset**
 2-7/8" cast rose in place of 2-1/4" wrought rose, substitute letter "F" in place of "A" (e.g. RWF). **Add \$77.00 per lockset**
 2. "R" Escutcheon trims are available for 1 3/8", 1 3/4", 2", or 2 1/4" door thickness only.
 3. VN escutcheon available only with indicators. Must be ordered with "V" indicator options. See page 114 for available functions. Option add also applies.



LSA
Lever: Cast
Rose: Wrought

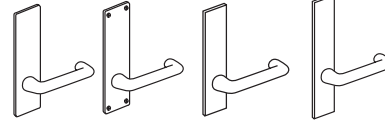

LSM LSN LSP LSR
Lever: Cast
Escutcheon: Wrought

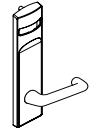

LSVN
Lever: Cast
Escutcheon:
Steel or Forged Brass

Levers: LS	
Roses: A	
Roses: B, F (see note 1)	
613E, 626, BSP, WSP	605, 606, 611, 612, 613, 618, 619, 625, 629, 630, 722

Levers: LS	
Escutcheons: M, N, P	
613E, 626, BSP, WSP	605, 606, 611, 612, 613, 618, 619, 625, 629, 630, 722

Levers: LS	
Escutcheons: R (see note 2)	
VN (see note 3)	
613E, 626, BSP, WSP	605, 606, 611, 612, 613, 618, 619, 625, 629, 630, 722

Function								
	Model	Description	Price 1	Price 2	Price 3	Price 4	Price 5	Price 6
Non-Keyed	ML2010	Passage	\$980.00	\$1,070.00	\$1,175.00	\$1,199.00	\$1,209.00	\$1,233.00
	ML2020	Privacy	\$1,205.00	\$1,295.00	\$1,415.00	\$1,439.00	\$1,449.00	\$1,473.00
	ML2030							
	ML2040	Passage w/Indicator - VXX Option on Page 114 Applies	\$1,170.00	\$1,260.00	\$1,380.00	\$1,404.00	\$1,414.00	\$1,438.00
	ML2060	Privacy						
	ML2050	Half Dummy	\$404.00	\$449.00	\$528.00	\$552.00	\$545.00	\$569.00
	ML2070	Full Dummy	\$808.00	\$898.00	\$1,056.00	\$1,080.00	\$1,090.00	\$1,114.00
	ML2080	Half Active Dummy Trim	\$720.00	\$765.00	\$755.00	\$767.00	\$772.00	\$784.00
	ML2090	Full Active Dummy Trim	\$1,024.00	\$1,114.00	\$1,256.00	\$1,280.00	\$1,290.00	\$1,314.00
Single Cylinder	ML2003	Classroom	\$1,271.00	\$1,361.00	\$1,481.00	\$1,505.00	\$1,515.00	\$1,539.00
	ML2051	Office						
	ML2055	Classroom						
	ML2056	Classroom						
	ML2057	Storeroom						
	ML2069	Institution Privacy						
	ML2004	Classroom	\$1,293.00	\$1,383.00	\$1,503.00	\$1,527.00	\$1,537.00	\$1,561.00
	ML2053	Entrance						
	ML2054	Entrance						
ML2058	Entrance Holdback							
ML2068	Privacy or Apartment							
Single Cylinder with Deadbolt	ML2024	Entrance	\$1,335.00	\$1,425.00	\$1,545.00	\$1,569.00	\$1,579.00	\$1,603.00
	ML2048	Entrance						
	ML2049	Storeroom Deadbolt						
	ML2065	Dormitory						
	ML2059	Security Storeroom						
	ML2067	Apartment						
	ML2073	Classroom Security						
	ML2075	Entrance/Office						
ML2029	Hotel	\$1,384.00	\$1,474.00	\$1,596.00	\$1,620.00	\$1,630.00	\$1,654.00	
Double Cylinder	ML2002	Classroom Intruder	\$1,401.00	\$1,491.00	\$1,611.00	\$1,635.00	\$1,645.00	\$1,669.00
	ML2032	Institution						
	ML2042	Entrance						
	ML2052	Classroom Intruder						
ML2087	Security Vestibule					N/A	N/A	
Double Cylinder with Deadbolt	ML2022	Store Door	\$1,465.00	\$1,555.00	\$1,675.00	\$1,699.00	\$1,709.00	\$1,733.00
	ML2062	Intruder Deadbolt						
	ML2072	Classroom Security Intruder						
	ML2082	Dormitory						
ML2092	Security Institution							
Full Working Trim (Quick Code M31) No cylinder; includes thumbturn lever			\$836.00	\$926.00	\$959.00	\$983.00	\$993.00	\$1,017.00

NOTES: 1. Rose substitutions for LSA: 2-1/4" cast rose in place of 2-1/4" wrought rose, substitute letter "B" in place of "A" (e.g. LSB). **Add \$57.00 per lockset**
 2-7/8" cast rose in place of 2-1/4" wrought rose, substitute letter "F" in place of "A" (e.g. LSF). **Add \$77.00 per lockset**
 2. "R" Escutcheon trims are available for 1 3/8", 1 3/4", or 2 1/4" door thickness only
 3. VN escutcheon available only with indicators. Must be ordered with "V" indicator options. See page 114 for available functions. Option add also applies.

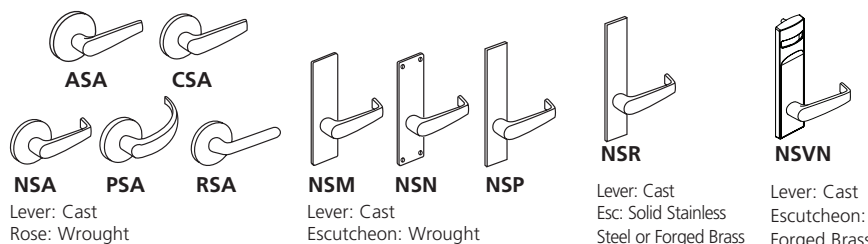

Levers: AS, CS, NS PS, RS Roses: A Roses: B, F (see note 1)	
613E, 626, BSP, WSP	605, 606, 611, 612, 613, 618, 619, 625, 629, 630, 722

Levers: AS, CS, NS, PS, RS Escutcheons: M, N, P	
613E, 626, BSP, WSP	605, 606, 611, 612, 613, 618, 619, 625, 629, 630, 722

Levers: AS, CS, NS, PS, RS Escutcheons: R (see note 2) VN (see note 3)	
613E, 626, BSP, WSP	605, 606, 611, 612, 613, 618, 619, 625, 629, 630, 722

Function			613E, 626, BSP, WSP	605, 606, 611, 612, 613, 618, 619, 625, 629, 630, 722	613E, 626, BSP, WSP	605, 606, 611, 612, 613, 618, 619, 625, 629, 630, 722	613E, 626, BSP, WSP	605, 606, 611, 612, 613, 618, 619, 625, 629, 630, 722
Non-Keyed	ML2010	Passage	\$1,155.00	\$1,179.00	\$1,175.00	\$1,199.00	\$1,209.00	\$1,233.00
	ML2020	Privacy	\$1,395.00	\$1,419.00	\$1,415.00	\$1,439.00	\$1,449.00	\$1,473.00
	ML2030							
	ML2040	Passage w/Indicator – VXX Option on Page 114 Applies	\$1,360.00	\$1,384.00	\$1,380.00	\$1,404.00	\$1,414.00	\$1,438.00
	ML2060	Privacy						
	ML2050	Half Dummy	\$474.00	\$486.00	\$484.00	\$496.00	\$501.00	\$513.00
	ML2070	Full Dummy	\$948.00	\$972.00	\$968.00	\$992.00	\$1,002.00	\$1,026.00
	ML2080	Half Active Dummy Trim	\$745.00	\$757.00	\$755.00	\$767.00	\$772.00	\$784.00
ML2090	Full Active Dummy Trim	\$1,236.00	\$1,260.00	\$1,256.00	\$1,280.00	\$1,290.00	\$1,314.00	
Single Cylinder	ML2003	Classroom	\$1,461.00	\$1,485.00	\$1,481.00	\$1,505.00	\$1,515.00	\$1,539.00
	ML2051	Office						
	ML2055	Classroom						
	ML2056	Classroom						
	ML2057	Storeroom						
	ML2069	Institution Privacy						
	ML2004	Classroom	\$1,483.00	\$1,507.00	\$1,503.00	\$1,527.00	\$1,537.00	\$1,561.00
	ML2053	Entrance						
ML2054	Entrance							
ML2058	Entrance Holdback							
ML2068	Privacy or Apartment							
Single Cylinder with Deadbolt	ML2024	Entrance	\$1,525.00	\$1,549.00	\$1,545.00	\$1,569.00	\$1,579.00	\$1,603.00
	ML2048	Entrance						
	ML2049	Storeroom Deadbolt						
	ML2065	Dormitory						
	ML2059	Security Storeroom						
	ML2067	Apartment						
	ML2073	Classroom Security						
	ML2075	Entrance/Office						
ML2029	Hotel	\$1,576.00	\$1,600.00	\$1,596.00	\$1,620.00	\$1,630.00	\$1,654.00	
Double Cylinder	ML2002	Classroom Intruder	\$1,591.00	\$1,615.00	\$1,611.00	\$1,635.00	\$1,645.00	\$1,669.00
	ML2032	Institution						
	ML2042	Entrance						
	ML2052	Classroom Intruder						
	ML2087	Security Vestibule						
Double Cylinder with Deadbolt	ML2022	Store Door	\$1,655.00	\$1,679.00	\$1,675.00	\$1,699.00	\$1,709.00	\$1,733.00
	ML2062	Intruder Deadbolt						
	ML2072	Classroom Security Intruder						
	ML2082	Dormitory						
	ML2092	Security Institution						
Full Working Trim (Quick Code M31) No cylinder; includes thumbturn lever			\$1,019.00	\$1,043.00	\$1,039.00	\$1,063.00	\$1,073.00	\$1,097.00

NOTES: 1. Rose substitutions for ASA, CSA, etc.: 2-1/4" cast rose in place of 2-1/4" wrought rose, substitute letter "B" in place of "A" (e.g. NSB). **Add \$57.00 per lockset**
 2-7/8" cast rose in place of 2-1/4" wrought rose, substitute letter "F" in place of "A" (e.g. NSF). **Add \$77.00 per lockset**
 2. "R" Escutcheon trims are available for 1 3/8", 1 3/4", or 2 1/4" door thickness only.
 3. VN escutcheon available only with indicators. Must be ordered with "V" indicator options. See page 114 for available functions. Option add also applies.



DSA
Lever: Cast
Rose: Wrought

ESA

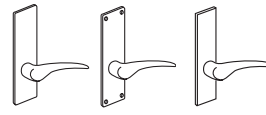

DSM **DSN** **DSP**
Lever: Cast
Escutcheon: Wrought

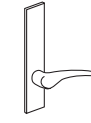

DSR
Lever: Cast
Esc: Solid Stainless
Steel or Forged Brass

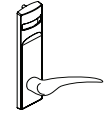

DSVN
Lever: Cast
Escutcheon:
Forged Brass

Levers: DS, ES	
Roses: A	
Roses: B, F (see note 1)	
613E, 626, BSP, WSP	605, 606, 611, 612, 613, 618, 619, 625, 629, 630, 722

Levers: DS, ES	
Escutcheons: M, N, P	
613E, 626, BSP, WSP	605, 606, 611, 612, 613, 618, 619, 625, 629, 630, 722

Levers: DS, ES	
Escutcheons: R (see note 2)	
VN (see note 3)	
613E, 626, BSP, WSP	605, 606, 611, 612, 613, 618, 619, 625, 629, 630, 722

Function			613E, 626, BSP, WSP		605, 606, 611, 612, 613, 618, 619, 625, 629, 630, 722		613E, 626, BSP, WSP		605, 606, 611, 612, 613, 618, 619, 625, 629, 630, 722		613E, 626, BSP, WSP		605, 606, 611, 612, 613, 618, 619, 625, 629, 630, 722	
	Non-Keyed	ML2010	Passage	\$1,191.00	\$1,215.00	\$1,211.00	\$1,235.00	\$1,245.00	\$1,269.00					
ML2020		Privacy	\$1,436.00	\$1,460.00	\$1,456.00	\$1,480.00	\$1,490.00	\$1,514.00						
ML2030														
ML2040		Passage w/Indicator – VXX Option on Page 114 Applies	\$1,401.00	\$1,425.00	\$1,421.00	\$1,445.00	\$1,455.00	\$1,479.00						
ML2060		Privacy												
ML2050		Half Dummy	\$490.00	\$502.00	\$500.00	\$512.00	\$517.00	\$529.00						
ML2070		Full Dummy	\$980.00	\$1,004.00	\$1,000.00	\$1,024.00	\$1,034.00	\$1,058.00						
ML2080		Half Active Dummy Trim	\$745.00	\$757.00	\$755.00	\$767.00	\$772.00	\$784.00						
ML2090	Full Active Dummy Trim	\$1,273.00	\$1,297.00	\$1,293.00	\$1,317.00	\$1,327.00	\$1,351.00							
Single Cylinder	ML2003	Classroom												
	ML2051	Office												
	ML2055	Classroom	\$1,502.00	\$1,526.00	\$1,522.00	\$1,546.00	\$1,556.00	\$1,580.00						
	ML2056	Classroom												
	ML2057	Storeroom												
	ML2069	Institution Privacy												
	ML2004	Classroom												
	ML2053	Entrance												
ML2054	Entrance	\$1,524.00	\$1,548.00	\$1,544.00	\$1,568.00	\$1,578.00	\$1,602.00							
ML2058	Entrance Holdback													
ML2068	Privacy or Apartment													
Single Cylinder with Deadbolt	ML2024	Entrance												
	ML2048	Entrance												
	ML2049	Storeroom Deadbolt												
	ML2065	Dormitory	\$1,566.00	\$1,590.00	\$1,586.00	\$1,610.00	\$1,620.00	\$1,644.00						
	ML2059	Security Storeroom												
	ML2067	Apartment												
	ML2073	Classroom Security												
ML2075	Entrance/Office													
ML2029	Hotel	\$1,615.00	\$1,639.00	\$1,635.00	\$1,659.00	\$1,669.00	\$1,693.00							
Double Cylinder	ML2002	Classroom Intruder												
	ML2032	Institution												
	ML2042	Entrance	\$1,632.00	\$1,656.00	\$1,652.00	\$1,676.00	\$1,686.00	\$1,710.00						
	ML2052	Classroom Intruder												
ML2087	Security Vestibule								N/A	N/A				
Double Cylinder with Deadbolt	ML2022	Store Door												
	ML2062	Intruder Deadbolt												
	ML2072	Classroom Security Intruder	\$1,696.00	\$1,720.00	\$1,716.00	\$1,740.00	\$1,750.00	\$1,774.00						
	ML2082	Dormitory												
ML2092	Security Institution													
Full Working Trim (Quick Code M31) No cylinder; includes thumbturn lever			\$1,099.00	\$1,123.00	\$1,119.00	\$1,143.00	\$1,153.00	\$1,177.00						

NOTES: 1. Rose substitutions for DSA, ESA: 2-1/4" cast rose in place of 2-1/4" wrought rose, substitute letter "B" in place of "A" (e.g. DSB). **Add \$57.00 per lockset**
2-7/8" cast rose in place of 2-1/4" wrought rose, substitute letter "F" in place of "A" (e.g. ESF). **Add \$77.00 per lockset**

2. "R" Escutcheon trims are available for 1 3/8", 1 3/4", or 2 1/4" door thickness only.

3. VN escutcheon available only with indicators. Must be ordered with "V" indicator options. See page 114 for available functions. Option add also applies.

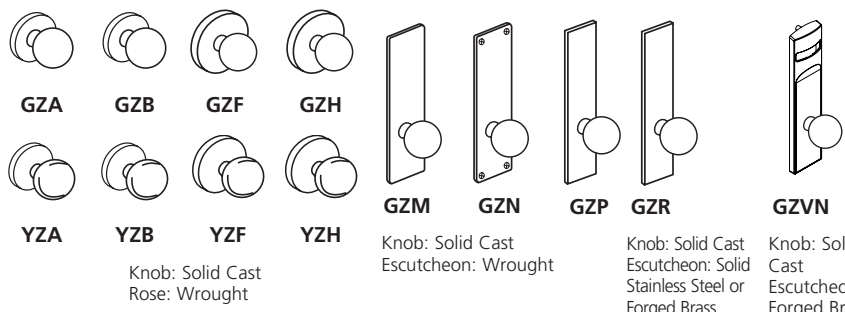

Function	Knobs: GZ, YZ Roses: A, H Roses: B, F (see note 2)		Knobs: GZ, YZ Escutcheons: M, N, P		Knobs: GZ, YZ Escutcheons: R (see note 2) VN (see note 3)			
	613E, 626, BSP, WSP	605, 606, 611, 612, 613, 618, 619, 625, 722	613E, 626, BSP, WSP	605, 606, 611, 612, 613, 618, 619, 625, 722	613E, 626, BSP, WSP	605, 606, 611, 612, 613, 618, 619, 625, 722		
Non-Keyed	ML2010	Passage	\$1,283.00	\$1,307.00	\$1,303.00	\$1,327.00	\$1,337.00	\$1,361.00
	ML2020	Privacy	\$1,475.00	\$1,499.00	\$1,495.00	\$1,519.00	\$1,529.00	\$1,553.00
	ML2030							
	ML2040	Passage w/Indicator - VXX Option on Page 114 Applies	\$1,456.00	\$1,480.00	\$1,476.00	\$1,500.00	\$1,510.00	\$1,534.00
	ML2060	Privacy						
	ML2050	Half Dummy	\$601.00	\$613.00	\$611.00	\$623.00	\$628.00	\$640.00
	ML2070	Full Dummy	\$1,202.00	\$1,226.00	\$1,222.00	\$1,246.00	\$1,256.00	\$1,280.00
	ML2080	Half Active Dummy Trim	\$685.00	\$697.00	\$695.00	\$707.00	\$712.00	\$724.00
ML2090	Full Active Dummy Trim	\$1,283.00	\$1,307.00	\$1,303.00	\$1,327.00	\$1,337.00	\$1,361.00	
Single Cylinder	ML2003	Classroom						
	ML2051	Office						
	ML2055	Classroom	\$1,541.00	\$1,565.00	\$1,561.00	\$1,585.00	\$1,595.00	\$1,619.00
	ML2056	Classroom						
	ML2057	Storeroom						
	ML2069	Institution Privacy						
	ML2004	Classroom						
	ML2053	Entrance	\$1,563.00	\$1,587.00	\$1,583.00	\$1,607.00	\$1,617.00	\$1,641.00
ML2054	Entrance							
ML2058	Entrance Holdback							
ML2068	Privacy or Apartment							
Single Cylinder with Deadbolt	ML2024	Entrance						
	ML2048	Entrance						
	ML2049	Storeroom Deadbolt	\$1,605.00	\$1,629.00	\$1,625.00	\$1,649.00	\$1,659.00	\$1,683.00
	ML2065	Dormitory						
	ML2059	Security Storeroom						
	ML2067	Apartment						
	ML2073	Classroom Security						
ML2075	Entrance/Office							
ML2029	Hotel	\$1,662.00	\$1,686.00	\$1,682.00	\$1,706.00	\$1,716.00	\$1,740.00	
Double Cylinder	ML2002	Classroom Intruder						
	ML2032	Institution	\$1,671.00	\$1,695.00	\$1,691.00	\$1,715.00	\$1,725.00	\$1,749.00
	ML2042	Entrance						
	ML2052	Classroom Intruder						
	ML2087	Security Vestibule						
						N/A	N/A	
Double Cylinder with Deadbolt	ML2022	Store Door						
	ML2062	Intruder Deadbolt	\$1,735.00	\$1,759.00	\$1,755.00	\$1,779.00	\$1,789.00	\$1,813.00
	ML2072	Classroom Security Intruder						
	ML2082	Dormitory						
	ML2092	Security Institution						
Full Working Trim (Quick Code M31) No cylinder; includes thumbturn lever.			\$1,173.00	\$1,197.00	\$1,193.00	\$1,217.00	\$1,227.00	\$1,251.00

- NOTES: 1. "R" Escutcheon trims are available for 1 3/8", 1 3/4", or 2 1/4" door thickness only.
 2. Rose substitutions: 2-1/4" cast rose in place of 2-1/4" wrought rose, substitute letter "B" in place of "A" (e.g. GZB). **Add \$57.00 per lockset**
 2-7/8" cast rose in place of 2-1/4" wrought rose, substitute letter "F" in place of "A" (e.g. GZF). **Add \$77.00 per lockset**
 3. VN escutcheon available only with indicators. Must be ordered with "V" indicator options. See page 114 for available functions. Option add also applies.

Lever Designs: FSG, MSG, ZSG

Lever: Rose:
Cast Cast



Frascati



Lever Designs: FSL, MSL¹, ZSL, FSVN, MSVN, ZSVN

Lever: Escutcheon:
Cast Cast

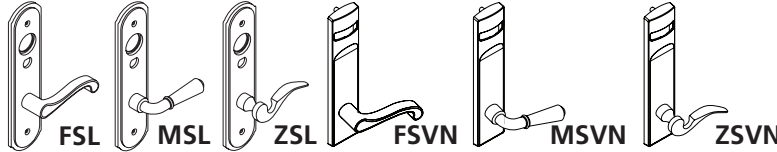

Merlot

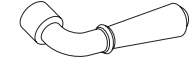

Zinfandel



Function	Description	FSG, MSG, ZSG		FSL, MSL, ZSL FSVN, MSVN, ZSVN (see note 3)		
		613E, 626, BSP, WSP	605, 606, 611, 612, 613 ² , 613L ² , 618, 619, 625, 722	613E, 626, BSP, WSP	605, 606, 611, 612, 613 ² , 613L ² , 618, 619, 625, 722	
Non-Keyed	ML2010	Passage	\$1,191.00	\$1,215.00	\$1,245.00	\$1,269.00
	ML2020	Privacy	\$1,436.00	\$1,460.00	\$1,490.00	\$1,514.00
	ML2030					
	ML2040	Passage w/Indicator – VXX Option on Page 114 Applies	\$1,401.00	\$1,425.00	\$1,455.00	\$1,479.00
	ML2060	Privacy				
	ML2050	Half Dummy	\$490.00	\$502.00	\$517.00	\$529.00
	ML2070	Full Dummy	\$980.00	\$1,004.00	\$1,034.00	\$1,058.00
	ML2080	Half Active Dummy Trim	\$745.00	\$757.00	\$772.00	\$784.00
ML2090	Full Active Dummy Trim	\$1,273.00	\$1,297.00	\$1,327.00	\$1,351.00	
Single Cylinder	ML2003	Classroom	\$1,502.00	\$1,526.00	\$1,556.00	\$1,580.00
	ML2051	Office				
	ML2055	Classroom				
	ML2056	Classroom Holdback				
	ML2057	Storeroom				
	ML2069	Institution Privacy				
	ML2004	Classroom	\$1,524.00	\$1,548.00	\$1,578.00	\$1,602.00
	ML2053	Entrance				
ML2054	Entrance					
ML2058	Entrance Holdback					
ML2068	Privacy or Apartment					
Single Cylinder with Deadbolt	ML2024	Entrance	\$1,566.00	\$1,590.00	\$1,620.00	\$1,644.00
	ML2048	Entrance				
	ML2049	Storeroom Deadbolt				
	ML2059	Dormitory				
	ML2065	Security Storeroom				
	ML2067	Apartment				
	ML2073	Classroom Security				
	ML2075	Entrance/Office				
ML2029	Hotel	\$1,615.00	\$1,639.00	\$1,669.00	\$1,693.00	
Double Cylinder	ML2002	Classroom Intruder	\$1,632.00	\$1,656.00	\$1,686.00	\$1,710.00
	ML2032	Institution				
	ML2042	Entrance				
	ML2052	Classroom Intruder				
	ML2087	Security Vestibule			N/A	N/A
Double Cylinder with Deadbolt	ML2022	Store Door	\$1,696.00	\$1,720.00	\$1,750.00	\$1,774.00
	ML2062	Intruder Deadbolt				
	ML2072	Classroom Security Intrude				
	ML2082	Dormitory				
	ML2092	Security Institution				
Full Working Trim (Quick Code M31) No cylinder; includes thumbturn lever			\$1,099.00	\$1,123.00	\$1,153.00	\$1,177.00

NOTES: 1. Escutcheon trims are available for 1-3/8", 1-3/4" or 2-1/4" door thicknesses only.
 2. 613 finish is brass base lever & rose/escutcheon.
 3. VN escutcheon available only with indicators. Must be ordered with "V" indicator options. See page 114 for available functions. Option add also applies.

Deadbolt Only

Include lockcase, armored front, strike, screw pack, cylinder(s) and thumbturn lever.

Ordering Example

Quantity	Series/Function	Trim Design (Escutcheon Type Only)	Finish	Door Thickness
12	ML2013	N	626	D138

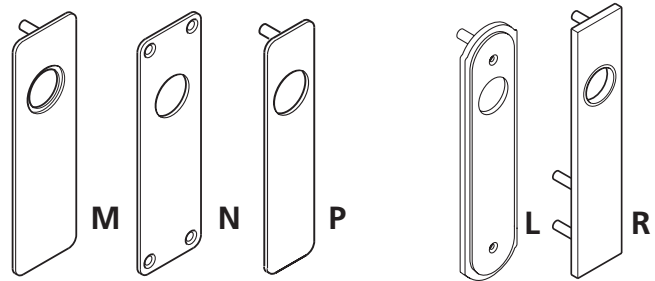

Deadlock No Trim

Function	
613E, 626, BSP, WSP	605, 606, 611, 612, 613, 618, 619, 625, 629, 630, 722

Wrought

M, N, P	
613E, 626, BSP, WSP	605, 606, 611, 612, 613, 618, 619, 625, 629, 630, 722

L, R: Solid Stainless Steel or Forged Brass

L, R	
613E, 626, BSP, WSP	605, 606, 611, 612, 613, 618, 619, 625, 629, 630, 722

Function	Series	613E, 626, BSP, WSP	605, 606, 611, 612, 613, 618, 619, 625, 629, 630, 722	M, N, P	L, R
Single Cylinder	ML2011	\$603.00	\$609.00	\$674.00	\$763.00
Double Cylinder	ML2012	\$733.00	\$739.00	\$837.00	\$949.00
Cylinder x Thumbturn	ML2013	\$625.00	\$631.00	\$729.00	\$841.00
Classroom Function Cylinder x Thumbturn	ML2017	\$625.00	\$631.00	\$729.00	\$841.00

NOTES: 1. Escutcheon trims are available for 1 3/8", 1 3/4", or 2 1/4" door thickness only.
2. VN escutcheon available only with sectional V series indicators. See page 114 for option codes.

Vandal Resistant Trim

Lever Designs: CSV, NSV

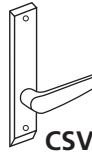

CSV

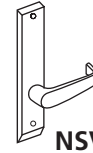

NSV

Lever: Cast
Escutcheon: Cast

Citation



Newport

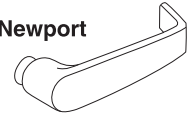

Function

CSV, NSV

630

Non-Keyed	ML2010VR	Passage	\$2,489.00
	ML2020VR	Privacy	\$2,651.00
	ML2030VR		\$2,599.00
	ML2060VR		
	ML2090VR		
Single Cylinder	ML2003VR	Classroom	\$2,717.00
	ML2051VR	Office	
	ML2055VR	Classro0m	
	ML2056VR	Classroom Holdback	
	ML2057VR	Storeroom	
	ML2069VR	Institution Privacy	\$2,739.00
	ML2004VR	Classroom	
	ML2053VR	Entrance	
	ML2054VR	Entrance	
	ML2058VR	Entrance Holdback	
Single Cylinder with Deadbolt	ML2024VR	Entrance	\$2,781.00
	ML2048VR	Entrance	
	ML2049VR	Storeroom Deadbolt	
	ML2059VR	Security Storeroom	
	ML2065VR	Dormitory	
	ML2067VR	Apartment	
	ML2073VR	Classroom Security	
	ML2075VR	Entrance/Office	
ML2029VR	Hotel	\$2,849.00	
Double Cylinder	ML2002VR	Classroom Intruder	\$2,847.00
	ML2032VR	Institution	
	ML2042VR	Entrance	
	ML2052VR	Classroom	
	ML2022VR	Store Door	\$2,911.00
	ML2062VR	Intruder Deadbolt	
	ML2072VR	Classroom Security Intruder	
	ML2082VR	Dormitory	
ML2092VR	Security Institution		
Deadlock	ML2011VR	Single Cylinder	\$2,209.00
	ML2013VR	Cylinder x Thumbturn	
	ML2017VR	Double Cylinder	\$2,339.00
	ML2012VR	Double Cylinder	
Full Working Trim (Quick Code M31) No cylinder; includes thumbturn lever			\$2,077.00

NOTE:
Escutcheon trims are available for 1 3/4", 2", or 2 1/4" door thickness only

Mortise Locksets

ML20900 Series Muséo Levers and Inspire Roseless Trim

USA & Canada Prices Effective March 3, 2025



contemporary levers to complement the interior design of your next project

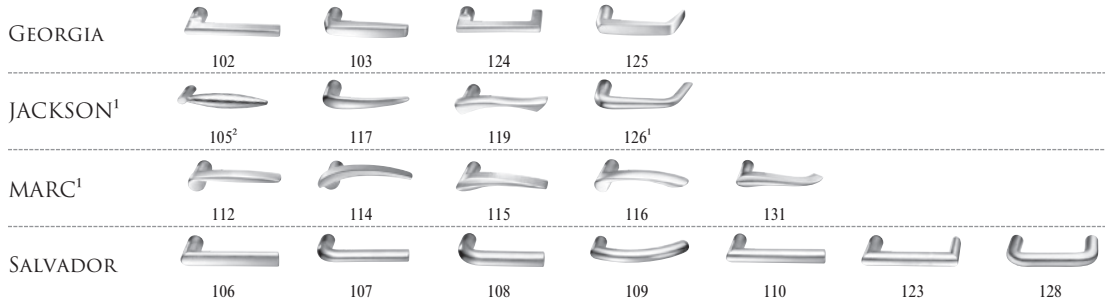

J Collar

1. Handed: specify hand when ordering
2. Contact factory for current lead time

613E	Dark Oxidized Satin Bronze - Equivalent	605	Bright Brass, Clear Coated	618	Bright Nickel Plated
626	Satin Chromium Plated	606	Satin Brass, Clear Coated	619	Satin Nickel Plated
BSP	Black Suede Powder Coat	611	Bright Bronze, Clear Coated	625	Bright Chromium Plated
WSP	White Suede Powder Coat	612	Satin Bronze, Clear Coated	629*	Bright Stainless Steel
		613	Dark Oxidized Satin Bronze, Oil Rubbed	630*	Satin Stainless Steel
		613L	Dark Oxidized Satin Bronze, Clear Coated	722	Black Oxidized Bronze, Oil Rubbed

Function

Lever with Roses				
Single Cylinder	ML20914	Fail Safe/Fail Secure	\$2,108.00	\$2,132.00
	ML20906			
No Cylinder Override	ML20907	Fail Safe/Fail Secure	\$1,978.00	\$2,002.00
	ML20915			
Double Cylinder	ML20932	Fail Safe/Fail Secure	\$2,238.00	\$2,262.00
	ML20987			



Ordering Example Details

ML2000	ML2051	Office Function
Sectional Trim (rose)	102	Georgia Family Lever
	J	Collar
	625	Finish
	RHR	Handing

Stock Order

Quantity	Series/Function	Trim	Finish	Hand
24	ML2051	102J	625	RHR

*629 and *630 finish options are Not available for all Muséo levers. Please refer to page 22 for availability.



Experience a safer and more open world

Electrically Controlled Mortise Locksets

ML20900 Series: Muséo Levers, Escutcheons, Roses and Thumbturns

USA & Canada Prices Effective March 3, 2025

contemporary levers to complement the interior design of your next project

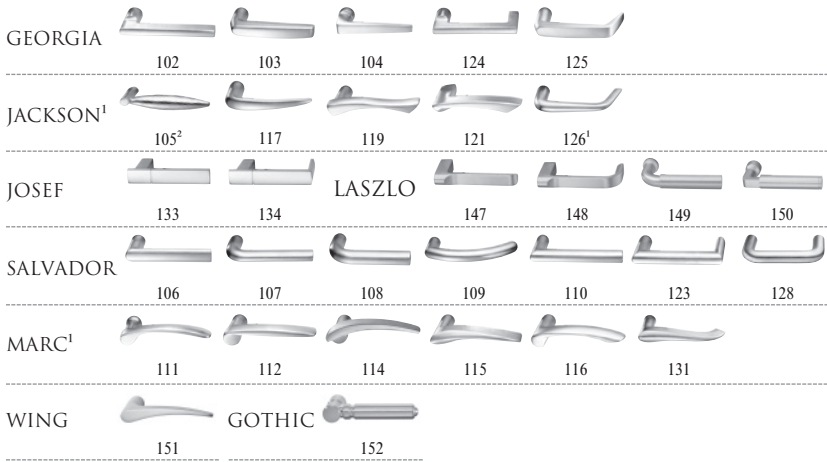

ROSES

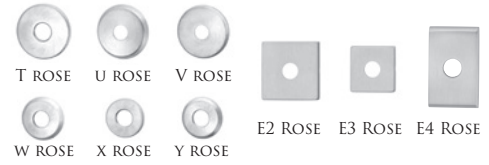

ESCUTCHEONS



THUMBTURNS³



1. Handed: specify hand when ordering
2. Contact factory for current lead time
3. Specify thumbturn as quick code. Thumbturn backplate will match shape of rose chosen (i.e. round or square). Not available with escutcheons.
4. ML20987 not available for L or R escutcheons.

*629 and *630 finish options are Not available for all Muséo levers. Please refer to page 22 for availability.

613E	Dark Oxidized Satin Bronze - Equivalent	605	Bright Brass, Clear Coated	618	Bright Nickel Plated
626	Satin Chromium Plated	606	Satin Brass, Clear Coated	619	Satin Nickel Plated
BSP	Black Suede Powder Coat	611	Bright Bronze, Clear Coated	625	Bright Chromium Plated
WSP	White Suede Powder Coat	612	Satin Bronze, Clear Coated	629*	Bright Stainless Steel
		613	Dark Oxidized Satin Bronze, Oil Rubbed	630*	Satin Stainless Steel
		613L	Dark Oxidized Satin Bronze, Clear Coated	722	Black Oxidized Bronze, Oil Rubbed

Function

Lever with Escutcheons: L,R						
Single Cylinder	ML20914	Fail Safe/Fail Secure*	\$1,956.00			\$1,980.00
	ML20906					
No Cylinder Override	ML20907	Fail Safe/Fail Secure*	\$1,826.00			\$1,850.00
	ML20915					
Double Cylinder	ML20932	Fail Safe/Fail Secure*	\$2,086.00			\$2,110.00
	ML20987		N/A			N/A
Lever with Roses: V,U,T,Y,X,W,E2,E3,E4						
Single Cylinder	ML20914	Fail Safe/Fail Secure*	\$1,887.00			\$1,911.00
	ML20906					
No Cylinder Override	ML20907	Fail Safe/Fail Secure*	\$1,757.00			\$1,781.00
	ML20915					
Double Cylinder	ML20932	Fail Safe/Fail Secure*	\$2,017.00			\$2,041.00
	ML20987					

*Must specify: SAF for Fail Safe or SEC for Fail Secure.



Ordering Example Details

ML20900 ECL	ML20914	Single Cylinder
Escutcheon Trim	SEC	Fail Secure
	104	Salvador Family Lever
	L	Escutcheon
	613	Finish
	RHR	Handing
	24 AD	24 Volt AC/DC

Stock Order

Quantity	Series/Function	Fail Safe/Fail Secure	Trim	Finish	Hand	Voltage
24	ML20914	SEC	104L	613	RHR	24 AD



Experience a safer and more open world

Electrically Controlled Mortise Locksets

ML20900 Series: Muséo Levers, Escutcheons, Roses and Thumbturns

USA & Canada Prices Effective March 3, 2025



contemporary levers to complement the interior design of your next project

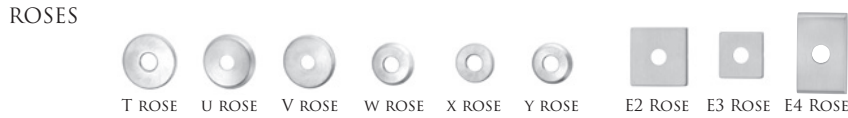

Specify thumbturn as quick code. Thumbturn backplate will match shape of rose chosen (i.e. round or square)

NOTE: ML20987 not available with L or R escutcheons.

613E	Dark Oxidized Satin Bronze – Equivalent
629	Bright Stainless Steel
630	Satin Stainless Steel
BSP	Black Suede Powder Coat
WSP	White Suede Powder Coat

Function

Lever with Escutcheons: L,R			
Single Cylinder	ML20914	Fail Safe/Fail Secure*	\$2,175.00
	ML20906		
No Cylinder Override	ML20907	Fail Safe/Fail Secure*	\$2,045.00
	ML20915		
Double Cylinder	ML20932	Fail Safe/Fail Secure*	\$2,305.00
	ML20987		N/A
Lever with Roses: V,U,T,Y,X,W,E2,E3,E4			
Single Cylinder	ML20914	Fail Safe/Fail Secure*	\$2,078.00
	ML20906		
No Cylinder Override	ML20907	Fail Safe/Fail Secure*	\$1,948.00
	ML20915		
Double Cylinder	ML20932	Fail Safe/Fail Secure*	\$2,208.00
	ML20987		

*Must specify: SAF for Fail Safe or SEC for Fail Secure.

BHMA CERTIFIED ML20900 ECL Escutcheon Trim

Ordering Example Details →

ML20914	Single Cylinder
SAF	Fail Safe
21M	Piet Family Lever - Polished with Satin Insert
L	Escutcheon
293029	Lever Finish
	Polished with satin stainless steel insert (630), polished stainless steel (629) shank and polished stainless steel (629) grip
629	Lock Finish
RHR	Handing
24 AD	24 Volt AC/DC

Stock Order							
Quantity	Series/Function	Fail Safe/Fail Secure	Trim	Lever Finish	Lock Finish	Hand	Voltage
2	ML20914	SAF	21ML	293029	629	RHR	24 AD



Experience a safer and more open world

Electrically Controlled Mortise Locksets

ML20900 Series: Muséo Levers, Escutcheons, Roses and Thumbturns

USA & Canada Prices Effective March 3, 2025

contemporary levers to complement the interior design of your next project

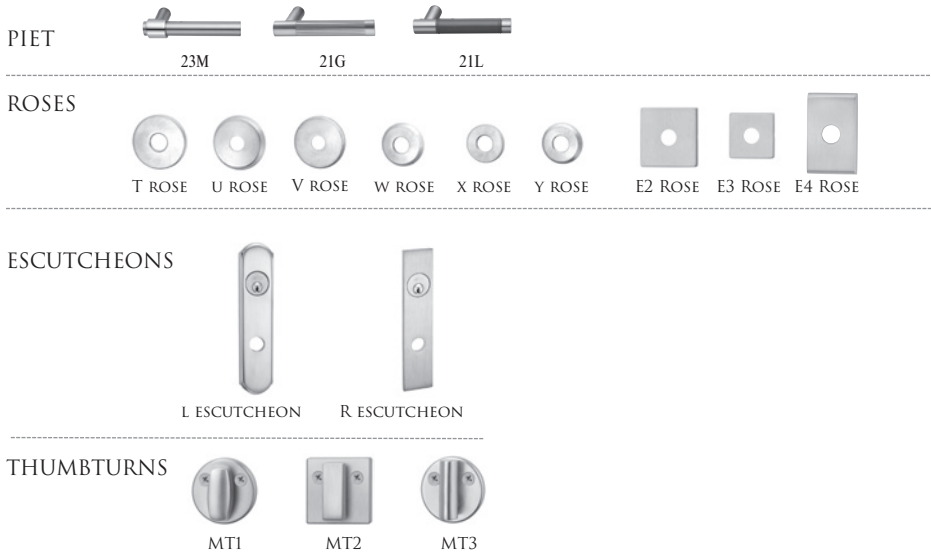

Specify thumbturn as quick code. Thumbturn backplate will match shape of rose chosen (i.e. round or square)

NOTE: ML20987 not available with L or R escutcheons.

613E	Dark Oxidized Satin Bronze – Equivalent
629	Bright Stainless Steel
630	Satin Stainless Steel
BSP	Black Suede Powder Coat
WSP	White Suede Powder Coat

Function

Lever with Escutcheons: L,R			
Single Cylinder	ML20914	Fail Safe/Fail Secure*	\$2,302.00
	ML20906		
No Cylinder Override	ML20907	Fail Safe/Fail Secure*	\$2,172.00
	ML20915		
Double Cylinder	ML20932	Fail Safe/Fail Secure*	\$2,432.00
	ML20987		N/A
Lever with Roses: V,U,T,Y,X,W,E2,E3,E4			
Single Cylinder	ML20914	Fail Safe/Fail Secure*	\$2,207.00
	ML20906		
No Cylinder Override	ML20907	Fail Safe/Fail Secure*	\$2,077.00
	ML20915		
Double Cylinder	ML20932	Fail Safe/Fail Secure*	\$2,337.00
	ML20987		

*Must specify: SAF for Fail Safe or SEC for Fail Secure.

BHMA CERTIFIED Ordering Example Details →

ML20900 ECL ML20914 Single Cylinder
 Escutcheon SEC Fail Secure
 Trim 23M Piet Family Lever - Wood Insert
 L Escutcheon
 29BH29 Lever Finish
 Wood insert with polished stainless steel (629)
 shank and polished stainless steel (629) grip
 629 Lock Finish
 RHR Handing
 24 AD 24 Volt AC/DC

Stock Order							
Quantity	Series/Function	Fail Safe/Fail Secure	Trim	Lever Finish	Lock Finish	Hand	Voltage
2	ML20914	SEC	21ML	29BH29	629	RHR	24 AD



Experience a safer and more open world

Electrically Controlled Mortise Locksets

ML20900 Series: Muséo Levers, Escutcheons, Roses and Thumbturns

USA & Canada Prices Effective March 3, 2025

contemporary levers to complement the interior design of your next project



JOSEF



GEORGES



ROSES

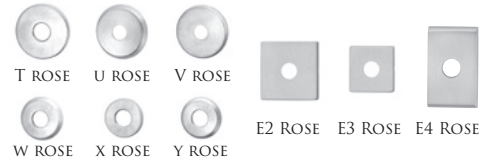

ESCUTCHEONS



THUMBTURNS³



1. Handed: specify hand when ordering
2. Contact factory for current lead time
3. Specify thumbturn as quick code. Thumbturn backplate will match shape of rose chosen (i.e. round or square). Not available with escutcheons.
4. ML20987 not available with L or R escutcheons.

613E	Dark Oxidized Satin Bronze - Equivalent	605	Bright Brass, Clear Coated	618	Bright Nickel Plated
626	Satin Chromium Plated	606	Satin Brass, Clear Coated	619	Satin Nickel Plated
BSP	Black Suede Powder Coat	611	Bright Bronze, Clear Coated	625	Bright Chromium Plated
WSP	White Suede Powder Coat	612	Satin Bronze, Clear Coated	629	Bright Stainless Steel
		613	Dark Oxidized Satin Bronze, Oil Rubbed	630	Satin Stainless Steel
		613L	Dark Oxidized Satin Bronze, Clear Coated	722	Black Oxidized Bronze, Oil Rubbed

Function

Lever with Escutcheons: L,R					
Single Cylinder	ML20914	Fail Safe/Fail Secure*	\$2,278.00		\$2,302.00
	ML20906				
No Cylinder Override	ML20907	Fail Safe/Fail Secure*	\$2,148.00		\$2,172.00
	ML20915				
Double Cylinder	ML20932	Fail Safe/Fail Secure*	\$2,408.00		\$2,432.00
	ML20987		N/A		N/A
Lever with Roses: V,U,T,Y,X,W,E2,E3,E4					
Single Cylinder	ML20914	Fail Safe/Fail Secure*	\$2,183.00		\$2,207.00
	ML20906				
No Cylinder Override	ML20907	Fail Safe/Fail Secure*	\$2,053.00		\$2,077.00
	ML20915				
Double Cylinder	ML20932	Fail Safe/Fail Secure*	\$2,313.00		\$2,337.00
	ML20987				

*Must specify: SAF for Fail Safe or SEC for Fail Secure.

Ordering Example Details

ML20900 ECL	ML20914	Single Cylinder
Escutcheon Trim	SEC	Fail Secure
	135	Josef Family Lever
	L	Escutcheon
	613	Finish
	RHR	Handing
	24 AD	24 Volt AC/DC



Stock Order									
Quantity	Series/Function	Technology Code	Trim	Finish	Hand	Voltage	Fail Safe/Fail Secure	High Security Monitoring Options	
24	ML20914	NAC	135L	613	RHR	24 AD	SEC	PHRR01	





Experience a safer and more open world

Electrically Controlled Mortise Locksets

ML20900 Series

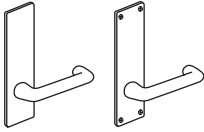
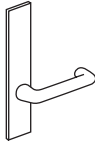
USA & Canada Prices Effective March 3, 2025

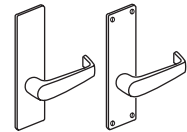
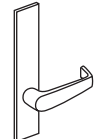
			 LWA RWA Lever: Wrought Rose: Wrought		 LWM LWN Lever: Wrought Escutcheon: Wrought		 LWR Lever: Wrought Escutcheon: Solid Stainless Steel or Forged Brass	
			Levers: LW, RW Roses: A Roses: B, F (see note 1)		Levers: LW, RW Escutcheons: M, N		Levers: LW, RW Escutcheons: R (see note 2)	
Description	Function	Option (See Note 3)	613E, 626, BSP, WSP	605, 606, 611, 612, 613, 618, 619, 625, 629, 630, 722	613E, 626, BSP, WSP	605, 606, 611, 612, 613, 618, 619, 625, 629, 630, 722	613E, 626, BSP, WSP	605, 606, 611, 612, 613, 618, 619, 625, 629, 630, 722
Single Cylinder	ML20914	Fail Safe/Fail Secure	\$1,565.00	\$1,589.00	\$1,591.00	\$1,615.00	\$1,662.00	\$1,686.00
	ML20906							
No Cylinder Override	ML20907	Fail Safe/Fail Secure	\$1,435.00	\$1,459.00	\$1,461.00	\$1,485.00	\$1,532.00	\$1,556.00
	ML20915							
Double Cylinder	ML20932	Fail Safe/Fail Secure	\$1,695.00	\$1,719.00	\$1,721.00	\$1,745.00	\$1,792.00	\$1,816.00
	ML20987						N/A	N/A
			 ASA CSA LSA Lever: Cast Rose: Wrought		 NSM NSN Lever: Cast Escutcheon: Wrought		 NSR Lever: Cast Escutcheon: Solid Stainless Steel or Forged Brass	
			Levers: AS, CS, LS, NS, PS, RS Roses: A Roses: B, F (see note 1)		Levers: AS, CS, LS, NS, PS, RS Escutcheons: M, N		Levers: AS, CS, LS, NS, PS, RS Escutcheons: R (see note 2)	
Description	Function	Option (See Note 3)	613E, 626, BSP, WSP	605, 606, 611, 612, 613, 618, 619, 625, 629, 630, 722	613E, 626, BSP, WSP	605, 606, 611, 612, 613, 618, 619, 625, 629, 630, 722	613E, 626, BSP, WSP	605, 606, 611, 612, 613, 618, 619, 625, 629, 630, 722
Single Cylinder	ML20914	Fail Safe/Fail Secure	\$1,844.00	\$1,868.00	\$1,871.00	\$1,895.00	\$1,915.00	\$1,939.00
	ML20906							
No Cylinder Override	ML20907	Fail Safe/Fail Secure	\$1,714.00	\$1,738.00	\$1,741.00	\$1,765.00	\$1,785.00	\$1,809.00
	ML20915							
Double Cylinder	ML20932	Fail Safe/Fail Secure	\$1,974.00	\$1,998.00	\$2,001.00	\$2,025.00	\$2,045.00	\$2,069.00
	ML20987						N/A	N/A

NOTES:

- 1 - Rose substitutions for LWA, LSA, etc.: 2-1/4" cast rose in place of 2-1/4" wrought rose, substitute letter "B" in place of "A" (e.g. LSB). **Add \$57.00 per lockset**
- 2-7/8" cast rose in place of 2-1/4" wrought rose, substitute letter "F" in place of "A" (e.g. LWF). **Add \$77.00 per lockset**
- 2 - "R" Escutcheon trims are available for 1 3/8", 1 3/4" or 2 1/4" door thickness only.
- 3. Must Specify: SAF for Fail Safe or SEC for Fail Secure.

ElectroLynx®

As part of their promise to provide innovative, fast and effective high security solutions to their customers, certain ASSA ABLOY Group brands offer *ElectroLynx®*, a universal quick-connect system that simplifies the electrification of the door opening.

Electrically Controlled Mortise Locksets

ML20900 Series

USA & Canada Prices Effective March 3, 2025



Lever: Cast
Rose: Wrought

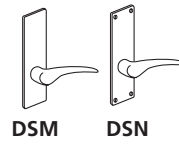

Lever: Cast
Escutcheon: Wrought

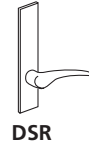

Lever: Cast
Escutcheon: Solid Stainless Steel
or Forged Brass

Description	Function	Option (See Note 3)	Lever: DS, ES Roses: A Roses: B, F (see note 1)		Lever: DS, ES Escutcheons: M, N		Lever: DS, ES Escutcheons: R (see note 2)	
			613E, 626, BSP, WSP	605, 606, 611, 612, 613, 618, 619, 625, 629, 630, 722	613E, 626, BSP, WSP	605, 606, 611, 612, 613, 618, 619, 625, 629, 630, 722	613E, 626, BSP, WSP	605, 606, 611, 612, 613, 618, 619, 625, 629, 630, 722
Single Cylinder	ML20914	Fail Safe/Fail Secure	\$1,887.00	\$1,911.00	\$1,913.00	\$1,937.00	\$1,956.00	\$1,980.00
	ML20906							
No Cylinder Override	ML20907	Fail Safe/Fail Secure	\$1,757.00	\$1,781.00	\$1,783.00	\$1,807.00	\$1,826.00	\$1,850.00
	ML20915							
Double Cylinder	ML20932	Fail Safe/Fail Secure	\$2,017.00	\$2,041.00	\$2,043.00	\$2,067.00	\$2,086.00	\$2,110.00
	ML20987						N/A	N/A

NOTES:

- 1 - Rose substitutions for DSA, ESA: 2-1/4" cast rose in place of 2-1/4" wrought rose, substitute letter "B" in place of "A" (e.g.DSB). **Add \$57.00 per lockset.** 2-7/8" cast rose in place of 2-1/4" wrought rose, substitute letter "F" in place of "A" (e.g. ESF). **Add \$77.00 per lockset.**
- 2 - "R" Escutcheon trims are available for 1 3/8", 1 3/4", or 2 1/4" door thickness only.
- 3. Must Specify: SAF for Fail Safe or SEC for Fail Secure.

Lever Designs: CSV, NSV

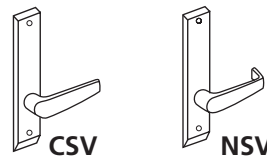

Lever: Cast
Escutcheon: Cast

Description	Function	Option (See Note 3)	CSV, NSV	
			Finish: 630	
Single Cylinder	ML20914VR	Fail Safe/Fail Secure	\$2,747.00	
	ML20906VR			
No Cylinder Override	ML20907VR	Fail Safe/Fail Secure	\$2,617.00	
	ML20915VR			
Double Cylinder	ML20932VR	Fail Safe/Fail Secure	\$2,877.00	

Note:

- Escutcheon trims are available for 1 3/8", 1 3/4", or 2 1/4" door thickness only.
- 3. Must Specify: SAF for Fail Safe or SEC for Fail Secure.

ElectroLynx®

As part of their promise to provide innovative, fast and effective high security solutions to their customers, certain ASSA ABLOY Group brands offer *ElectroLynx®*, a universal quick-connect system that simplifies the electrification of the door opening.

Lever Designs: FSG, MSG, ZSG



Frascati



Lever: Rose:
Cast Cast



Vineyard™
collection

Merlot



Lever Designs: FSL, MSL, ZSL



Zinfandel

Lever: Escutcheon:
Cast Cast

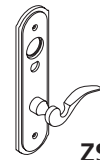
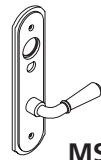

Vineyard™
collection



Description	Function	Option (See Note 3)	FSG, MSG, ZSG		FSL, MSL, ZSL	
			613E, 626, BSP, WSP	605, 606, 611, 612, 613 ² , 613L ² , 618, 619, 625, 722	613E, 626, BSP, WSP	605, 606, 611, 612, 613 ² , 613L ² , 618, 619, 625, 722
Single Cylinder	ML20914	Fail Safe/Fail Secure	\$1,887.00	\$1,911.00	\$1,956.00	\$1,980.00
	ML20906					
No Cylinder Override	ML20907	Fail Safe/Fail Secure	\$1,757.00	\$1,781.00	\$1,826.00	\$1,850.00
	ML20915					
Double Cylinder	ML20932	Fail Safe/Fail Secure	\$2,017.00	\$2,041.00	\$2,086.00	\$2,110.00
	ML20987				N/A	N/A

Notes:

1. Escutcheon trims are available for 1-3/8", 1-3/4" or 2-1/4" door thicknesses only.
2. 613 finish is brass base lever & rose/escutcheon.
3. Must Specify: SAF for Fail Safe or SEC for Fail Secure

ElectroLynx®

As part of their promise to provide innovative, fast and effective high security solutions to their customers, certain ASSA ABLOY Group brands offer *ElectroLynx®*, a universal quick-connect system that simplifies the electrification of the door opening.

Electrically Controlled Mortise Locksets ML20900 Series

USA & Canada Prices Effective March 3, 2025



GZA GZB GZF GZH



YZA YZB YZF YZH

Knob: Solid Cast
Rose: Wrought

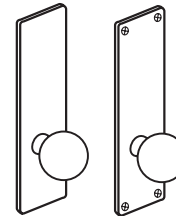

GZM GZN

Knob: Solid Cast
Escutcheon: Wrought



GZR

Knob: Solid Cast
Escutcheon: Solid Stainless Steel or Forged Brass

Knobs: GZ, YZ Roses: A, H Roses: B, F (see note 2)	
613E, 626, BSP, WSP	605, 606, 611, 612, 613, 618, 619, 625, 722

Knobs: GZ, YZ Escutcheons: M, N	
613E, 626, BSP, WSP	605, 606, 611, 612, 613, 618, 619, 625, 722

Knobs: GZ, YZ Escutcheons: R (see note 1)	
613E, 626, BSP, WSP	605, 606, 611, 612, 613, 618, 619, 625, 722

Description	Function	Option (See Note 3)	613E, 626, BSP, WSP	605, 606, 611, 612, 613, 618, 619, 625, 722	613E, 626, BSP, WSP	605, 606, 611, 612, 613, 618, 619, 625, 722	613E, 626, BSP, WSP	605, 606, 611, 612, 613, 618, 619, 625, 722
Single Cylinder	ML20914	Fail Safe/ Fail Secure	\$1,935.00	\$1,959.00	\$1,961.00	\$1,985.00	\$2,007.00	\$2,031.00
	ML20906							
No Cylinder Override	ML20907	Fail Safe/ Fail Secure	\$1,805.00	\$1,829.00	\$1,831.00	\$1,855.00	\$1,877.00	\$1,901.00
	ML20915							
Double Cylinder	ML20932	Fail Safe/ Fail Secure	\$2,065.00	\$2,089.00	\$2,091.00	\$2,115.00	\$2,137.00	\$2,161.00
	ML20987						N/A	N/A

NOTE 1: "R" Escutcheon trims are available for 1 3/8", 1 3/4", or 2 1/4" door thickness only.

NOTE 2: Rose substitutions: 2-1/4" cast rose in place of 2-1/4" wrought rose, substitute letter "B" in place of "A" (e.g. GZB). **Add \$57.00 per lockset**
2-7/8" cast rose in place of 2-1/4" wrought rose, substitute letter "F" in place of "A" (e.g. GZF). **Add \$77.00 per lockset**

NOTE 3: Must Specify: SAF for Fail Safe or SEC for Fail Secure.

ElectroLynx®

As part of their promise to provide innovative, fast and effective high security solutions to their customers, certain ASSA ABLOY Group brands offer *ElectroLynx®*, a universal quick-connect system that simplifies the electrification of the door opening.

Electrically Controlled Mortise Locksets

ML20600 NAC Series Electrified Mortise Lock with High Security Monitoring

USA & Canada Prices Effective March 3, 2025



contemporary levers to complement the interior design of your next project

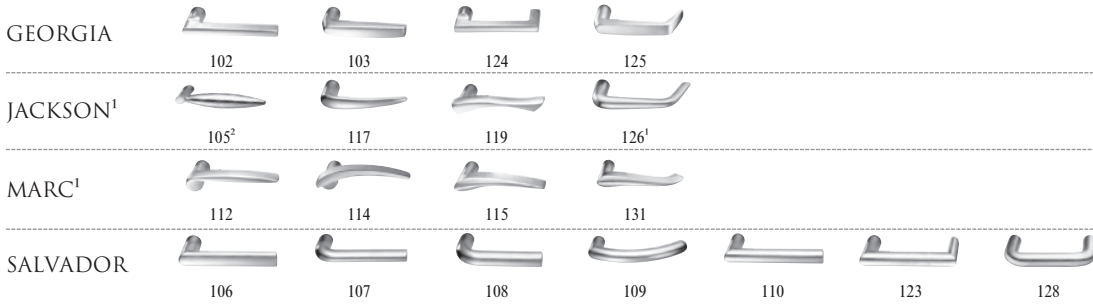

1. Handed: specify hand when ordering
2. Contact factory for current lead time

613E	Dark Oxidized Satin Bronze - Equivalent	605	Bright Brass, Clear Coated	618	Bright Nickel Plated
626	Satin Chromium Plated	606	Satin Brass, Clear Coated	619	Satin Nickel Plated
BSP	Black Suede Powder Coat	611	Bright Bronze, Clear Coated	625	Bright Chromium Plated
WSP	White Suede Powder Coat	612	Satin Bronze, Clear Coated	629*	Bright Stainless Steel
		613	Dark Oxidized Satin Bronze, Oil Rubbed	630*	Satin Stainless Steel
		613L	Dark Oxidized Satin Bronze, Clear Coated	722	Black Oxidized Bronze, Oil Rubbed

Function

Lever with Roses					
Single Cylinder	ML20606 x NAC	Fail Safe/Fail Secure	\$2,333.00		\$2,357.00
	ML20608 x NAC	Fail Safe/Fail Secure	\$2,434.00		\$2,458.00
No Cylinder Override	ML20607 x NAC	Fail Safe/Fail Secure	\$2,193.00		\$2,217.00
	ML20609 x NAC	Fail Safe/Fail Secure	\$2,293.00		\$2,317.00

ML20600 High Security Monitoring Options

Description	Specify	Add or Deduct
Mercury and Lenel compatible 1KΩ/2KΩ resistance supervision	R01	Add \$136.00 per lockset
Software House compatible 1KΩ/2KΩ resistance supervision	R03	Add \$136.00 per lockset
AMAG compatible 4-state supervision	R04	Add \$136.00 per lockset
Deadbolt Privacy Function	PHR	Add \$136.00 per lockset
Deadbolt Privacy and Mercury / Lenel 1KΩ/2KΩ	PHRR01	Add \$272.00 per lockset
Deadbolt Privacy and Software House 1KΩ/2KΩ	PHRR03	Add \$272.00 per lockset
Deadbolt Privacy and AMAG 4-State	PHRR04	Add \$272.00 per lockset



Ordering Example Details →

ML2000 Mortise Lock x NAC x No Cylinder x Deadbolt x Fail-Secure

- Muséo® lever 102 with J Collar
- Polished chrome finish
- Right hand reverse
- Deadbolt privacy function, Mercury and Lenel compatible 1KΩ/2KΩ resistance supervision

Stock Order							
Quantity	Series/Function	Technology Code	Trim	Finish	Hand	Fail Safe/Fail Secure	High Security Monitoring Options
24	ML20608	NAC	102J	625	RHR	SEC	PHRR01

*629 and *630 finish options are Not available for all Muséo levers. Please refer to page 22 for availability.



Experience a safer and more open world

Electrically Controlled Mortise Locksets

ML20600 NAC Series Electrified Mortise Lock with High Security Monitoring

USA & Canada Prices Effective March 3, 2025



contemporary levers to complement the interior design of your next project

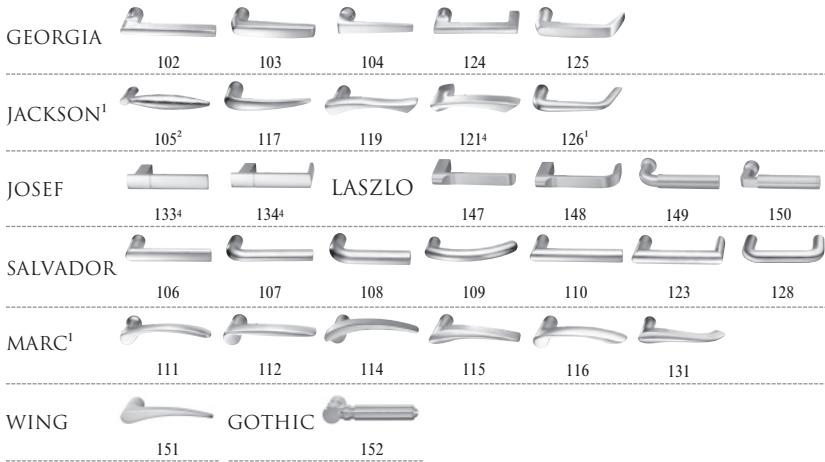

ROSES

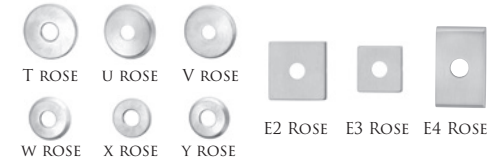

ESCUTCHEONS



THUMBTURNS³



1. Handed: specify hand when ordering
2. Contact factory for current lead time
3. Specify thumbturn as quick code. Thumbturn backplate will match shape of rose chosen (i.e. round or square). Not available with escutcheons.
4. Not available with VN escutcheon.
5. VN escutcheon available only with indicators. Must be ordered with "V" indicator options. See page 114 for available functions. Option add also applies.

*629 and *630 finish options are Not available for all Muséo levers. Please refer to page 22 for availability.

Function

613E	Dark Oxidized Satin Bronze - Equivalent	605	Bright Brass, Clear Coated	618	Bright Nickel Plated
626	Satin Chromium Plated	606	Satin Brass, Clear Coated	609	Satin Nickel Plated
BSP	Black Suede Powder Coat	611	Bright Bronze, Clear Coated	625	Bright Chromium Plated
WSP	White Suede Powder Coat	612	Satin Bronze, Clear Coated	629*	Bright Stainless Steel
		613	Dark Oxidized Satin Bronze, Oil Rubbed	630*	Satin Stainless Steel
		613L	Dark Oxidized Satin Bronze, Clear Coated	722	Black Oxidized Bronze, Oil Rubbed

Lever with Escutcheons: L,R					
Single Cylinder	ML20606 x NAC	Fail Safe/Fail Secure	\$2,187.00		\$2,211.00
	ML20608 x NAC	Fail Safe/Fail Secure	\$2,285.00		\$2,309.00
No Cylinder Override	ML20607 x NAC	Fail Safe/Fail Secure	\$2,049.00		\$2,073.00
	ML20609 x NAC	Fail Safe/Fail Secure	\$2,148.00		\$2,172.00

Lever with Roses: V,U,T,Y,X,W,E2,E3,E4					
Single Cylinder	ML20606 x NAC	Fail Safe/Fail Secure	\$2,114.00		\$2,138.00
	ML20608 x NAC	Fail Safe/Fail Secure	\$2,214.00		\$2,238.00
No Cylinder Override	ML20607 x NAC	Fail Safe/Fail Secure	\$1,977.00		\$2,001.00
	ML20609 x NAC	Fail Safe/Fail Secure	\$2,076.00		\$2,100.00

*Must specify: SAF for Fail Safe or SEC for Fail Secure.

ML20600 High Security Monitoring Options

Description	Specify	Add or Deduct
Mercury and Lenel compatible 1KΩ/2KΩ resistance supervision	R01	Add \$136.00 per lockset
Software House compatible 1KΩ/2KΩ resistance supervision	R03	Add \$136.00 per lockset
AMAG compatible 4-state supervision	R04	Add \$136.00 per lockset
Deadbolt Privacy Function	PHR	Add \$136.00 per lockset
Deadbolt Privacy and Mercury / Lenel 1KΩ/2KΩ	PHRR01	Add \$272.00 per lockset
Deadbolt Privacy and Software House 1KΩ/2KΩ	PHRR03	Add \$272.00 per lockset
Deadbolt Privacy and AMAG 4-State	PHRR04	Add \$272.00 per lockset



Ordering Example Details →

ML20600 NAC
Escutcheon Trim

ML20608	Single Cylinder
SEC	Fail Secure
104	Salvador Family Lever
L	Escutcheon
613	Finish
RHR	Handing
24 AD	24 Volt AC/DC

Stock Order

Quantity	Series/Function	Technology Code	Trim	Finish	Hand	Fail Safe/Fail Secure	High Security Monitoring Options
24	ML20608	NAC	104L	613	RHR	SEC	PHRR01



ASSA ABLOY

Experience a safer and more open world

Electrically Controlled Mortise Locksets

ML20600 NAC Series Electrified Mortise Lock with High Security Monitoring

USA & Canada Prices Effective March 3, 2025



contemporary levers to complement the interior design of your next project

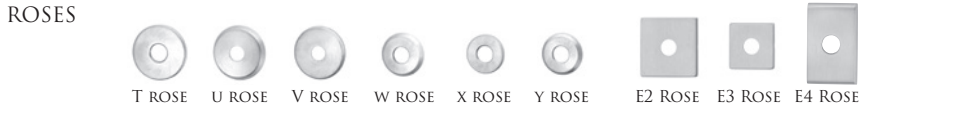

Specify thumbturn as quick code. Thumbturn backplate will match shape of rose chosen (i.e. round or square)

NOTES:
1. VN escutcheon available only with indicators. Must be ordered with "V" indicator options. See page 114 for available functions. Option add also applies.

613E	Dark Oxidized Satin Bronze – Equivalent
629	Bright Stainless Steel
630	Satin Stainless Steel
BSP	Black Suede Powder Coat
WSP	White Suede Powder Coat

Function

Lever with Escutcheons: L,R			
Single Cylinder	ML20606 x NAC	Fail Safe/Fail Secure*	\$2,402.00
	ML20608 x NAC		\$2,500.00
No Cylinder Override	ML20607 x NAC	Fail Safe/Fail Secure*	\$2,265.00
	ML20609 x NAC		\$2,363.00
Lever with Roses: V,U,T,Y,X,W,E2,E3,E4			
Single Cylinder	ML20606 x NAC	Fail Safe/Fail Secure*	\$2,308.00
	ML20608 x NAC		\$2,407.00
No Cylinder Override	ML20607 x NAC	Fail Safe/Fail Secure*	\$2,169.00
	ML20609 x NAC		\$2,269.00

ML20600 High Security Monitoring Options

Description	Specify	Add or Deduct
Mercury and Lenel compatible 1KΩ/2KΩ resistance supervision	R01	Add \$136.00 per lockset
Software House compatible 1KΩ/2KΩ resistance supervision	R03	Add \$136.00 per lockset
AMAG compatible 4-state supervision	R04	Add \$136.00 per lockset
Deadbolt Privacy Function	PHR	Add \$136.00 per lockset
Deadbolt Privacy and Mercury / Lenel 1KΩ/2KΩ	PHRR01	Add \$272.00 per lockset
Deadbolt Privacy and Software House 1KΩ/2KΩ	PHRR03	Add \$272.00 per lockset
Deadbolt Privacy and AMAG 4-State	PHRR04	Add \$272.00 per lockset

*Must specify: SAF for Fail Safe or SEC for Fail Secure.

Ordering Example Details

ML20600 NAC ML20914 Single Cylinder
 Escutcheon SEC Fail Secure
 Trim 23M Piet Family Lever - Wood Insert
 L Escutcheon
 29BH29 Lever Finish Wood insert with polished stainless steel (629) shank and polished stainless steel (629) grip
 Lock Finish
 629 Handing
 RHR
 24 AD 24 Volt AC/DC

Stock Order										
Qty	Series/Function	Tech. Code	Trim	Lever Finish	Finish	Hand	Voltage	Fail Safe/Fail Secure	High Security Monitoring Options	
2	ML20608	NAC	21ML	29BH29	629	RHR	24 AD	SEC	PHRR01	



Experience a safer and more open world

Electrically Controlled Mortise Locksets

ML20600 NAC Series Electrified Mortise Lock with High Security Monitoring

USA & Canada Prices Effective March 3, 2025



contemporary levers to complement the interior design of your next project

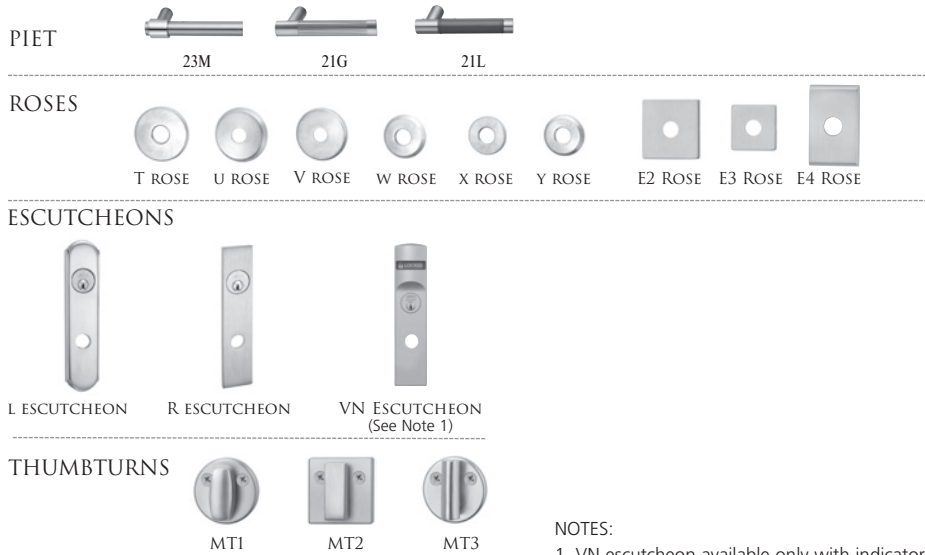

Specify thumbturn as quick code. Thumbturn backplate will match shape of rose chosen (i.e. round or square)

NOTES:

1. VN escutcheon available only with indicators. Must be ordered with "V" indicator options. See page 114 for available functions. Option add also applies.

613E	Dark Oxidized Satin Bronze – Equivalent
629	Bright Stainless Steel
630	Satin Stainless Steel
BSP	Black Suede Powder Coat
WSP	White Suede Powder Coat

Function

Lever with Escutcheons: L,R			
Single Cylinder	ML20606 x NAC	Fail Safe/Fail Secure*	\$2,532.00
	ML20608 x NAC		\$2,630.00
No Cylinder Override	ML20607 x NAC	Fail Safe/Fail Secure*	\$2,394.00
	ML20609 x NAC		\$2,493.00
Lever with Roses: V,U,T,Y,X,W,E2,E3,E4			
Single Cylinder	ML20606 x NAC	Fail Safe/Fail Secure*	\$2,436.00
	ML20608 x NAC		\$2,534.00
No Cylinder Override	ML20607 x NAC	Fail Safe/Fail Secure*	\$2,298.00
	ML20609 x NAC		\$2,396.00

ML20600 High Security Monitoring Options

Description	Specify	Add or Deduct
Mercury and Lenel compatible 1KΩ/2KΩ resistance supervision	R01	Add \$136.00 per lockset
Software House compatible 1KΩ/2KΩ resistance supervision	R03	Add \$136.00 per lockset
AMAG compatible 4-state supervision	R04	Add \$136.00 per lockset
Deadbolt Privacy Function	PHR	Add \$136.00 per lockset
Deadbolt Privacy and Mercury / Lenel 1KΩ/2KΩ	PHRR01	Add \$272.00 per lockset
Deadbolt Privacy and Software House 1KΩ/2KΩ	PHRR03	Add \$272.00 per lockset
Deadbolt Privacy and AMAG 4-State	PHRR04	Add \$272.00 per lockset

*Must specify: SAF for Fail Safe or SEC for Fail Secure.

BHMA CERTIFIED Ordering Example Details

ML20600 NAC	ML20608 Single Cylinder
Escutcheon Trim	SEC Fail Secure
23M	Piet Family Lever - Wood Insert
L	Escutcheon
29BH29	Lever Finish
629	Wood insert with polished stainless steel (629) shank and polished stainless steel (629) grip
RHR	Lock Finish
24 AD	Handing
	24 Volt AC/DC

Stock Order

Qty	Series/Function	Tech. Code	Trim	Lever Finish	Finish	Hand	Voltage	Fail Safe/Fail Secure	High Security Monitoring Options
2	ML20608	NAC	21ML	29BH29	629	RHR	24 AD	SEC	PHRR01



Experience a safer and more open world

Electrically Controlled Mortise Locksets

ML20600 NAC Series Electrified Mortise Lock with High Security Monitoring

USA & Canada Prices Effective March 3, 2025

contemporary levers to complement the interior design of your next project



JOSEF



GEORGES



ROSES

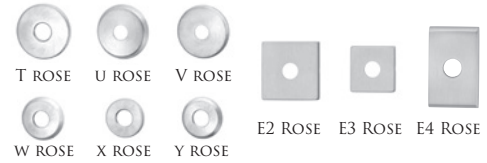

ESCUTCHEONS



THUMBTURNS³



1. Handed: specify hand when ordering.
2. Contact factory for current lead time.
3. Specify thumbturn as quick code. Thumbturn backplate will match shape of rose chosen (i.e. round or square).
Not available with escutcheons.
4. Not available with escutcheon indicators.

613E	Dark Oxidized Satin Bronze - Equivalent	605	Bright Brass, Clear Coated	618	Bright Nickel Plated
626	Satin Chromium Plated	606	Satin Brass, Clear Coated	609	Satin Nickel Plated
BSP	Black Suede Powder Coat	611	Bright Bronze, Clear Coated	625	Bright Chromium Plated
WSP	White Suede Powder Coat	612	Satin Bronze, Clear Coated	629	Bright Stainless Steel
		613	Dark Oxidized Satin Bronze, Oil Rubbed	630	Satin Stainless Steel
		613L	Dark Oxidized Satin Bronze, Clear Coated	722	Black Oxidized Bronze, Oil Rubbed

Function

Lever with Escutcheons: L,R					
Single Cylinder	ML20606 x NAC	Fail Safe/Fail Secure	\$2,508.00		\$2,532.00
	ML20608 x NAC	Fail Safe/Fail Secure	\$2,606.00		\$2,630.00
No Cylinder Override	ML20607 x NAC	Fail Safe/Fail Secure	\$2,370.00		\$2,394.00
	ML20609 x NAC	Fail Safe/Fail Secure	\$2,469.00		\$2,493.00

Lever with Roses: V,U,T,Y,X,W,E2,E3,E4					
Single Cylinder	ML20606 x NAC	Fail Safe/Fail Secure	\$2,412.00		\$2,436.00
	ML20608 x NAC	Fail Safe/Fail Secure	\$2,510.00		\$2,534.00
No Cylinder Override	ML20607 x NAC	Fail Safe/Fail Secure	\$2,274.00		\$2,298.00
	ML20609 x NAC	Fail Safe/Fail Secure	\$2,372.00		\$2,396.00

*Must specify: SAF for Fail Safe or SEC for Fail Secure.

ML20600 High Security Monitoring Options

Description	Specify	Add or Deduct
Mercury and Lenel compatible 1KΩ/2KΩ resistance supervision	R01	Add \$136.00 per lockset
Software House compatible 1KΩ/2KΩ resistance supervision	R03	Add \$136.00 per lockset
AMAG compatible 4-state supervision	R04	Add \$136.00 per lockset
Deadbolt Privacy Function	PHR	Add \$136.00 per lockset
Deadbolt Privacy and Mercury / Lenel 1KΩ/2KΩ	PHRR01	Add \$272.00 per lockset
Deadbolt Privacy and Software House 1KΩ/2KΩ	PHRR03	Add \$272.00 per lockset
Deadbolt Privacy and AMAG 4-State	PHRR04	Add \$272.00 per lockset

BHMA CERTIFIED	Ordering Example Details
ML20600 NAC Escutcheon Trim	ML20608 Single Cylinder SEC Fail Secure 104 Salvador Family Lever L Escutcheon 613 Finish RHR Handing 24 AD 24 Volt AC/DC

Stock Order								
Quantity	Series/Function	Technology Code	Trim	Finish	Hand	Fail Safe/Fail Secure	High Security Monitoring Options	
24	ML20608	NAC	135L	613	RHR	SEC	PHRR01	



Experience a safer and more open world

Electrified Mortise Lock with High Security Monitoring ML20600 Series NAC

USA & Canada Prices Effective March 3, 2025

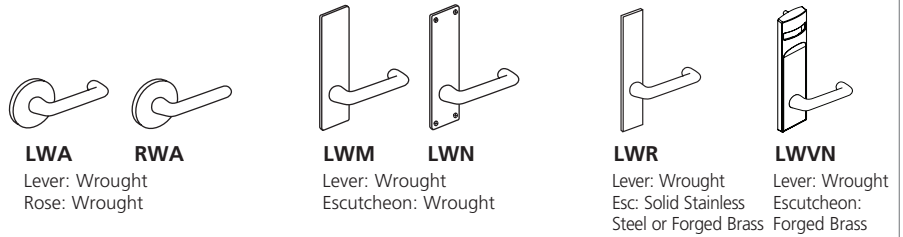

Description	Function	Option (See Note 3)	Levers: LW, RW Roses: A Roses: B, F (see note 1)		Levers: LW, RW Escutcheons: M, N		Levers: LW, RW Escutcheons: R (see note 2) VN (see note 4)	
			613E, 626, BSP, WSP	605, 606, 611, 612, 613, 618, 619, 625, 629, 630, 722	613E, 626, BSP, WSP	605, 606, 611, 612, 613, 618, 619, 625, 629, 630, 722	613E, 626, BSP, WSP	605, 606, 611, 612, 613, 618, 619, 625, 629, 630, 722
Single Cylinder	ML20606 x NAC	Fail Safe/Fail Secure	\$1,794.00	\$1,818.00	\$1,820.00	\$1,844.00	\$1,891.00	\$1,915.00
	ML20608 x NAC		\$1,892.00	\$1,916.00	\$1,918.00	\$1,942.00	\$1,990.00	\$2,014.00
No Cylinder Override	ML20607 x NAC	Fail Safe/Fail Secure	\$1,657.00	\$1,681.00	\$1,683.00	\$1,707.00	\$1,753.00	\$1,777.00
	ML20609 x NAC		\$1,754.00	\$1,778.00	\$1,780.00	\$1,804.00	\$1,851.00	\$1,875.00

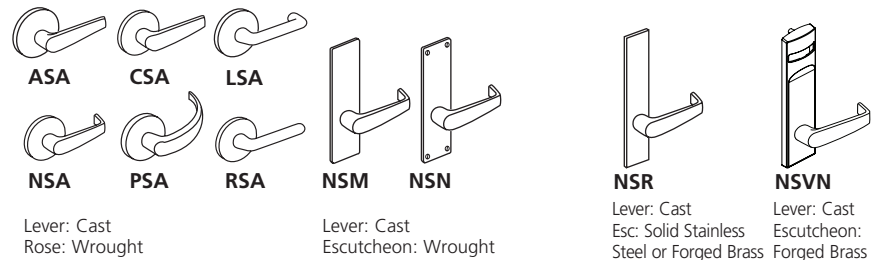

Description	Function	Option (See Note 3)	Levers: AS, CS, LS, NS, PS, RS Roses: A Roses: B, F (see note 1)		Levers: AS, CS, LS, NS, PS, RS Escutcheons: M, N		Levers: AS, CS, LS, NS, PS, RS Escutcheons: R (see note 2) VN (see note 4)	
			613E, 626, BSP, WSP	605, 606, 611, 612, 613, 618, 619, 625, 629, 630, 722	613E, 626, BSP, WSP	605, 606, 611, 612, 613, 618, 619, 625, 629, 630, 722	613E, 626, BSP, WSP	605, 606, 611, 612, 613, 618, 619, 625, 629, 630, 722
Single Cylinder	ML20606 x NAC	Fail Safe/Fail Secure	\$2,073.00	\$2,097.00	\$2,099.00	\$2,123.00	\$2,143.00	\$2,167.00
	ML20608 x NAC		\$2,172.00	\$2,196.00	\$2,196.00	\$2,220.00	\$2,242.00	\$2,266.00
No Cylinder Override	ML20607 x NAC	Fail Safe/Fail Secure	\$1,935.00	\$1,959.00	\$1,961.00	\$1,985.00	\$2,007.00	\$2,031.00
	ML20609 x NAC		\$2,034.00	\$2,058.00	\$2,059.00	\$2,083.00	\$2,104.00	\$2,128.00

- NOTES: 1. Rose substitutions for LWA, LSA, etc.: 2-1/4" cast rose in place of 2-1/4" wrought rose, substitute letter "B" in place of "A" (e.g. LSB).
Add \$57.00 per lockset. 2-7/8" cast rose in place of 2-1/4" wrought rose, substitute letter "F" in place of "A" (e.g. LWF). **Add \$77.00 per lockset.**
 2. "R" Escutcheon trims are available for 1 3/8", 1 3/4" or 2 1/4" door thickness only.
 3. Must Specify: SAF for Fail Safe or SEC for Fail Secure.
 4. VN escutcheon available only with indicators. Must be ordered with "V" indicator options. See page 114 for available functions.
 Option add also applies.

ElectroLynx®

As part of their promise to provide innovative, fast and effective high security solutions to their customers, certain ASSA ABLOY Group brands offer *ElectroLynx®*, a universal quick-connect system that simplifies the electrification of the door opening.

Electrified Mortise Lock with High Security Monitoring ML20600 Series NAC

USA & Canada Prices Effective March 3, 2025



DSA **ESA**
Lever: Cast
Rose: Wrought

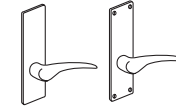

DSM **DSN**
Lever: Cast
Escutcheon: Wrought

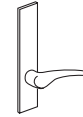

DSR
Lever: Cast
Esc: Solid Stainless
Steel or Forged Brass

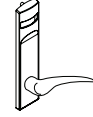

DSVN
Lever: Cast
Escutcheon:
Forged Brass

Lever: DS, ES
Roses: A
Roses: B, F (see note 1)

Lever: DS, ES
Escutcheons: M, N

Lever: DS, ES
Escutcheons: R (see note 2)
VN (see note 4)

Description	Function	Option (See Note 3)	Lever: DS, ES Roses: A		Lever: DS, ES Escutcheons: M, N		Lever: DS, ES Escutcheons: R (see note 2) VN (see note 4)	
			613E, 626, BSP, WSP	605, 606, 611, 612, 613, 618, 619, 625, 629, 630, 722	613E, 626, BSP, WSP	605, 606, 611, 612, 613, 618, 619, 625, 629, 630, 722	613E, 626, BSP, WSP	605, 606, 611, 612, 613, 618, 619, 625, 629, 630, 722
Single Cylinder	ML20606 x NAC	Fail Safe/Fail Secure	\$2,114.00	\$2,138.00	\$2,140.00	\$2,164.00	\$2,187.00	\$2,211.00
	ML20608 x NAC		\$2,214.00	\$2,238.00	\$2,238.00	\$2,262.00	\$2,285.00	\$2,309.00
No Cylinder Override	ML20607 x NAC	Fail Safe/Fail Secure	\$1,977.00	\$2,001.00	\$2,003.00	\$2,027.00	\$2,049.00	\$2,073.00
	ML20609 x NAC		\$2,076.00	\$2,100.00	\$2,101.00	\$2,125.00	\$2,148.00	\$2,172.00

NOTES: 1. Rose substitutions for DSA, ESA: 2-1/4" cast rose in place of 2-1/4" wrought rose, substitute letter "B" in place of "A" (e.g.DSB). **Add \$57.00 per lockset.**
2-7/8" cast rose in place of 2-1/4" wrought rose, substitute letter "F" in place of "A" (e.g. ESF). **Add \$77.00 per lockset.**
2. "R" Escutcheon trims are available for 1 3/8", 1 3/4", or 2 1/4" door thickness only.
3. Must Specify: SAF for Fail Safe or SEC for Fail Secure.
4. VN escutcheon available only with indicators. Must be ordered with "V" indicator options. See page 114 for available functions.
Option add also applies.

Lever Designs: CSV, NSV

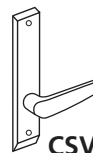

CSV

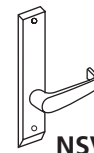

NSV

Lever: Cast
Escutcheon: Cast

Description	Function	Option (See Note 3)	CSV, NSV	
				Finish: 630
Single Cylinder	ML20606VR x NAC	Fail Safe/Fail Secure		\$2,975.00
	ML20608VR x NAC		\$3,073.00	
No Cylinder Override	ML20607VR x NAC	Fail Safe/Fail Secure		\$2,838.00
	ML20609VR x NAC		\$2,936.00	

Note:
Escutcheon trims are available for 1 3/8", 1 3/4", or 2 1/4" door thickness only.
3. Must Specify: SAF for Fail Safe or SEC for Fail Secure.

ElectroLynx®

As part of their promise to provide innovative, fast and effective high security solutions to their customers, certain ASSA ABLOY Group brands offer *ElectroLynx®*, a universal quick-connect system that simplifies the electrification of the door opening.

Electrified Mortise Lock with High Security Monitoring ML20600 Series NAC

USA & Canada Prices Effective March 3, 2025

Lever Designs: FSG, MSG, ZSG



Frascati



Lever: Rose:
Cast Cast



Merlot



Lever Designs: FSL, MSL, ZSL, FSVN, MSVN, ZSVN



Zinfandel



Lever: Escutcheon:
Cast Cast

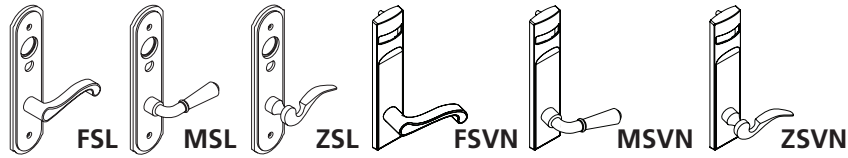

Description	Function	Option (See Note 3)	FSG, MSG, ZSG		FSL, MSL, ZSL FSVN, MSVN, ZSVN (see note 4)	
			Finish: 613E, 626, BSP, WSP	Finish: 605, 606, 611, 612, 613 ² , 613L ² , 618, 619, 625, 722	613E, 626, BSP, WSP	Finish: 605, 606, 611, 612, 613 ² , 613L ² , 618, 619, 625, 722
Single Cylinder	ML20606 x NAC	Fail Safe/Fail Secure	\$2,114.00	\$2,138.00	\$2,187.00	\$2,211.00
	ML20608 x NAC		\$2,214.00	\$2,238.00	\$2,285.00	\$2,309.00
No Cylinder Override	ML20607 x NAC	Fail Safe/Fail Secure	\$1,977.00	\$2,001.00	\$2,049.00	\$2,073.00
	ML20609 x NAC		\$2,076.00	\$2,100.00	\$2,148.00	\$2,172.00

- NOTES: 1. Escutcheon trims are available for 1-3/8", 1-3/4" or 2-1/4" door thicknesses only.
 2. 613 finish is brass base lever & rose/escutcheon.
 3. Must Specify: SAF for Fail Safe or SEC for Fail Secure.
 4. VN escutcheon available only with indicators. Must be ordered with "V" indicator options. See page 114 for available functions. Option add also applies.

ElectroLynx®

As part of their promise to provide innovative, fast and effective high security solutions to their customers, certain ASSA ABLOY Group brands offer *ElectroLynx®*, a universal quick-connect system that simplifies the electrification of the door opening.

Fail Safe/Fail Secure

Description	Specify Quick Code
Fail Safe	SAF
Fail Secure	SEC

Electrified Options

Description	Specify Quick Code	Add or Deduct
Latchbolt Monitor	M91	\$305.00
Request to Exit (REX)	M92	\$302.00
Security monitor	M105	\$529.00
Latchbolt monitor x request to exit	M91 x M92	\$607.00
Request to Exit x security monitor	M92 x M105	\$831.00
Motorized Electric Latch Retraction ¹	MELR	\$850.00
Motorized Electric Latch Retraction x Request to Exit ²	MELR x M92	\$1,152.00

Notes: 1. MELR only available with ML2010, ML2057 & ML2032.
 2. MELR x M92 only available with ML2010 & ML2057.

Accessories

Part No.	Description	Add or Deduct
BPS-24-1	Power Supply 24V 1 AMP	\$543.00
BPS-12-1	Power Supply 12V 1 AMP	
BPS-24-2	Power Supply 24V 2 AMP	\$1,115.00
BPS-12-3	Power Supply 12V 3 AMP	

ML20600 High Security Monitoring Options

EcoFlex® Mortise Lock End-of-Line Resistors and Deadbolt Privacy Options

Description	Specify Quick Code	Add or Deduct
Mercury and Lenel compatible 1KΩ/2KΩ resistance supervision	R01	Add \$136.00 per lockset
Software House compatible 1KΩ/2KΩ resistance supervision	R03	Add \$136.00 per lockset
AMAG compatible 4-state supervision	R04	Add \$136.00 per lockset
Deadbolt Privacy Function	PHR	Add \$136.00 per lockset
Deadbolt Privacy and Mercury / Lenel 1KΩ/2KΩ	PHRR01	Add \$272.00 per lockset
Deadbolt Privacy and Software House 1KΩ/2KΩ	PHRR03	Add \$272.00 per lockset
Deadbolt Privacy and AMAG 4-State	PHRR04	Add \$272.00 per lockset

ElectroLynx®

As part of their promise to provide innovative, fast and effective high security solutions to their customers, certain ASSA ABLOY Group brands offer *ElectroLynx®*, a universal quick-connect system that simplifies the electrification of the door opening.

Lock Only

Includes lockcase, armored front, strike and screw pack. Cylinder(s) and thumbturn lever are not included.

Ordering Example

Quantity	Series/Function	Trim See Key Below	Finish	Door Thickness	Optional Strike
12	ML2055	LL	626	D138	SS078

Trim Key

KK	Knob x Knob	LK	Lever x Knob	HL	Lever Inside only	LLBHSS	BHSS
LL	Lever x Lever	KL	Knob x Lever	HK	Knob inside Only		

Function	Description		LL, LK, KL, HL, HK ² , KK ² , LLBHSS
			Available in all listed mortise trim finishes
Non-Keyed	ML2010	Passage	\$582.00
	ML2020	Privacy	
	ML2030	Privacy	
	ML2040	Passage w/Indicator – VXX Option on Page 114 Applies	\$675.00
	ML2060	Privacy	
Single Cylinder	ML2003	Classroom	\$631.00
	ML2051	Office	
	ML2004	Classroom	
	ML2053	Entrance	\$647.00
	ML2054	Entrance	
	ML2055	Classroom	
	ML2056	Classroom Holdback	\$631.00
	ML2057	Storeroom	
	ML2058	Entrance Holdback	\$647.00
Single Cylinder with Deadbolt	ML2068	Privacy and Apartment	\$631.00
	ML2069	Institution Privacy	
	ML2024	Entrance	
	ML2048	Entrance	
	ML2049	Storeroom Deadbolt	
	ML2059	Security Storeroom	\$675.00
	ML2065	Dormitory	
	ML2067	Apartment	
	ML2073	Security	
ML2075	Classroom		
ML2029	Hotel	\$686.00	
Double Cylinder	ML2002	Classroom Intruder	
	ML2032	Institution	
	ML2042	Entrance	
	ML2052	Classroom	
	ML2087	Security Vestibule	\$631.00
	ML2022	Store Door	
	ML2062	Intruder	
	ML2072	Classroom	
	ML2082	Dormitory	
ML2092	Security Institution		
Single Cylinder	ML20914	Fail Safe/Fail Secure	
	ML20906		
No Cylinder Override	ML20907	Fail Safe/Fail Secure	\$973.00
	ML20915		
Double Cylinder	ML20932	Fail Safe/Fail Secure	
	ML20987	Security Vestibule	
Lock Only x MELR	ML2010	ML2010 Passage w/ MELR	\$1,432.00
	ML2057	ML2057 Storeroom w/ MELR	
	ML2032	ML2032 Institution w/ MELR	\$1,481.00
Lock Only x MELR x M92	ML2010	ML2010 Passage w/ MELR & M92	\$1,734.00
	ML2057	ML2057 Storeroom w/ MELR & M92	\$1,783.00

Notes: 1. Kits contain internal lock parts only. Order knobs, spindles, escutcheons, cylinders and collars separately.
2. For master ring, specify quick code MR-LC. Add \$20.00. Not available for ML20900 series.

Cylinder & Keying Options		
Description	Specify Quick Code	Add or Deduct
Conventional 6-pin	(standard)	No Charge
Conventional 7-pin	7P	Add \$2.00 per cylinder
Less Standard Cylinder	LC	Deduct \$130.00 per cylinder
Less Hotel Cylinder	LC	Deduct \$191.00 per cylinder
Less Master Ring Cylinder ³	MR-LC	Deduct \$40.00 per cylinder
Less Concealed Shell Cylinder	PO-LC	Add \$5.00 per lockset
LFIC		
LFIC 6-pin	C6	Add \$112.00 per cylinder
LFIC 6-pin Less Core	CL6	No Charge
LFIC 6-pin with Temporary Construction Core (Red)	CT6R	Add \$112.00 per cylinder
LFIC 6-pin with Temporary Construction Core (Blue)	CT6B	Add \$112.00 per cylinder
LFIC 6-pin with Temporary Construction Core (Green)	CT6G	Add \$112.00 per cylinder
LFIC 6-pin with Temporary Disposable Core	CT6D	No Charge
LFIC 7-pin	C7	Add \$114.00 per cylinder
LFIC 7-pin Less Core	CL7	Add \$2.00 per cylinder
LFIC 7-pin with Temporary Construction Core (Red)	CT7R	Add \$114.00 per cylinder
LFIC 7-pin with Temporary Construction Core (Blue)	CT7B	Add \$114.00 per cylinder
LFIC 7-pin with Temporary Construction Core (Green)	CT7G	Add \$114.00 per cylinder
LFIC 7-pin with Temporary Disposable Core	CT7D	Add \$2.00 per cylinder
SFIC		
SFIC 6-pin	C6S	Add \$101.00 per cylinder
SFIC 6-pin with Less Core	CLS6	No Charge
SFIC 6-pin with Temporary Construction Core (Blue)	CT6SB	Add \$101.00 per cylinder
SFIC 6-pin with SFIC disposable temporary core	CT6SD	No Charge
SFIC 7-pin	C7S	Add \$101.00 per cylinder
SFIC 7-pin with Less Core	CLS7	No Charge
SFIC 7-pin with Temporary Construction Core (Blue)	CT7SB	Add \$101.00 per cylinder
SFIC 7-pin with SFIC disposable temporary core	CT7SD	No Charge
Security		
Security ⁵	HS	Add \$171.00 per cylinder
Security LFIC ^{1,5}	CHS	Add \$279.00 per cylinder
Access 3		
Access 3 Patented	AP	No Charge
Access 3 Security	AS	Add \$84.00 per cylinder
Access 3 High Security, UL 437	AHS	Add \$120.00 per cylinder
Access 3 LFIC Patented	ACP	Add \$112.00 per cylinder
Access 3 LFIC Security	ACS	Add \$196.00 per cylinder
Access 3 LFIC High Security, UL 437	ACHS	Add \$232.00 per cylinder
Pyramid		
Pyramid Security Fixed Core ²	PS	Add \$90.00 per cylinder
Pyramid Security LFIC	PCS	Add \$196.00 per cylinder
Pyramid High Security Fixed Core	PHS	Add \$135.00 per cylinder
Pyramid High Security LFIC	PCHS	Add \$241.00 per cylinder
Pyramid LFIC with Temporary Construction Core ⁴	CTP	Add \$112.00 per cylinder
Pyramid LFIC with Temporary Disposable Core ⁴	CTPD	No Charge
Pyramid LFIC Less Core ²	CLP	No Charge
Other		
Master Ring ³	MR	Add \$92.00 per cylinder
Flex Head Cylinder, 6-pin (sectional trim)	FX6	Add \$116.00 per cylinder
Flex Head Cylinder, 7-pin (sectional trim)	FX7	Add \$118.00 per cylinder
Flex Head Master Ring (sectional trim)	FXM	Add \$188.00 per cylinder
Plug only to show, 6-pin (concealed shell) (avail: for M & R escutcheons and single cyl. functions only)	P06	Add \$130.00 per lockset
Plug only to show, 7-pin (concealed shell) (avail: for M & R escutcheons and single cyl. functions only)	P07	Add \$132.00 per lockset

Notes:

1. CHS ordered with CT6 option no charge.
2. Pyramid series and LFIC-7 pin are not available in ML2029 function.
3. Available for "M" escutcheon and sectional trim only. Not available for 17, 29 or 32 functions, and ECL functions. Not available for ML20900 series.
4. Refer to Key construction core program, pg. 28 for example of CTP option pricing.
5. For existing systems only.

Cylinder Options & Keying Options**

Description	Specify Quick Code	Add or Deduct
Keying and Keys		
0-bitted with 2 Blank Keys	(standard)	No Charge
Keyed Random	KR	
Construction Master Keyed ²	CMK	Add \$16.00 per cylinder
More than 2 Keys	KY# (e.g., KY6)	See page 29 - Cut Keys Section
Master Keying		
Master keyed (all cylinders except CR8000, CR8020, CR8027, CR8200, CR8500, CR8600, CR8700)	MK	Add \$16.00 per cylinder
Master keyed Pyramid (except CR8020, CR8027 LFIC cores)	MK	
Master keyed Security (including LFIC cylinder and core)	MK	
Master keyed Access 3 (except CR8500, CR8600, CR8700 LFIC cores)	MK	
Master keyed (CR8000, CR8020, CR8027, CR8200, CR8500, CR8600, CR8700)	MK-IC	No Charge
Master keyed to customer bittings or sample key	MK-CB	Add \$16.00 per cylinder

VISUAL CYLINDER/KEY CONTROL:

Description	Cylinders		Keys	
	Stamping	List Price	Stamping	List Price
VKC0 – No stamping except keyway designation (keys will be tagged)	No Stamping	No Charge	No Stamping	\$5/key
VKC1 – Keys only	N/A	N/A	Keyset	No Charge
VKC2 – Cylinder and keys*	Keyset	\$4/cyl	Keyset	No Charge
VKC3 – Cylinder*	Keyset	\$4/cyl	Bittings	No Charge
All VKC, VDC, or VAC stamping codes that use an alternate symbol	Alternate Stamping	\$4/cyl	Alternate Stamping	\$4/cyl

CONCEALED CYLINDER/VISUAL KEY CONTROL:

Description	Cylinders		Keys	
	Stamping	List Price	Stamping	List Price
CKC2 – Cylinder and Keys*	Keyset	\$4/cyl	Keyset	No Charge
CKC3 – Cylinders only*	Keyset	\$4/cyl	Bittings	No Charge
All CKC, CDC, or CAC stamping codes that use an alternate symbol	Alternate Stamping	\$4/cyl	Alternate Stamping	\$4/cyl

*Cylinder face stamping not available for Access 3, Pyramid, or Security products

Notes: 1. CMK Construction master keying charge is in addition to master keying charge.
2. CMK construction master keying is not available in interchangeable core, Access 3, Pyramid, or Security series.
**For key bows other than 10 and 90, specify 'KB' + bow number as Quick Code, e.g. KB12. No extra charge.

Strike Options*

(To purchase strike separately, see catalog or parts manual for part no.)

Lip Length	ANSI Straight Lip – Specify Quick Code	ANSI Curved Lip – Specify Quick Code	Add or Deduct
7/8"	SS078	N/A	No Charge
1-1/8"	(standard)	N/A	
1-1/4"	SS114	SA114	
1-3/8"	SS138	SA138	
1-1/2"	SS112	SA112	Add \$17.00 per lock
1-3/4"	SS134	SA134	
2"	SS200	SA200	
2-1/4"	SS214	SA214	
2-1/2"	SS212	SA212	
2-3/4"	SS234	SA234	
3"	SS300	SA300	
Description	Door Thickness	Specify Quick Code	Add or Deduct
Open Back Strike	1-3/4"	SB134	Add \$124.00 per lockset
Open Back Strike	2"	SB200	Add \$197.00 per lockset
Open Back Strike	2-1/4"	SB214	
Rabbeted front and strike		SR118	Add \$128.00 per lockset

* If door thickness is standard or has been specified and no special door or frame condition exist, then only the first two characters of the optional strike Quick Code must be specified (e.g. "SA"). The correct lip length will be determined by our order entry system based on the standard or specified door thickness.

Door Thickness with Locksets Mortised on Center

(Note: Door thickness with panel not to exceed 2" from centerline of lock.)

Door Thickness	Sectional Rose Trim Specify Quick Code	Escutcheon ^{1,2} Trim Specify Quick Code	Add or Deduct
1-3/4" (standard)	—	—	No Charge
1-3/8"	D138 ³	D138	Add \$58.00
1-7/8"	D178	N/A	No Charge
2"	D200	D200	
2-1/8"	D218	N/A	
2-1/4"	D214	D214	
2-3/8"	D238	D238	Add \$96.00 per lockset
2-1/2"	D212	D212	
2-5/8"	D258	D258	
2-3/4"	D234	D234	
2-7/8"	D278	D278	
3"	D300	D300	
3-1/8"	D318	D318	
3-1/4"	D314	D314	
3-3/8"	D338	D338	
3-1/2"	D312	D312	
3-5/8"	D358	D358	
3-3/4"	D334	D334	
3-7/8"	D378	D378	
4"	D400	D400	

Notes:

- For 2-3/8" to 4" door thickness: throughbolts and thumbturn lever spindle for 4" door will be provided. Throughbolts and spindles may be field cut.
- "R" and "L" escutcheons are only available for 1-3/8", 1-3/4" and 2-1/4" door thicknesses.
- Not available for ML20900 or ML20600-NAC.

Panel Applications

Specify Quick Code	Description	Add or Deduct
PNL ¹	Centerline of lockcase to edge of panel not to exceed 2"	Add \$96.00 per lockset

Note:

- When ordering, specify door thickness (less panel), panel thickness, and side of door panel will be applied (outside or inside).

Miscellaneous Options

Description	Specify Quick Code	Add or Deduct
Split designs and split finishes	Outside Trim x Inside Trim	Higher set price prevails
Spanner head screws	M02	Add \$30.00 per lockset
Torx® head screws (n/a with N escutcheon)	M04	Add \$36.00 per lockset
ANSI wrought strike box	M17	No Charge
Knurling outside and inside	M20**	Add \$212.00 per lockset
Knurling outside only	M21**	Add \$106.00 per lockset
Knurling inside only	M22**	Add \$106.00 per lockset
Abrasive coat outside and inside	M23 ¹	Add \$134.00 per lockset
Abrasive coat inside only	M24 ¹	Add \$67.00 per lockset
Abrasive coat outside only	M25 ¹	Add \$67.00 per lockset
Non-ferrous lockcase	M26	Add \$383.00 per lockset
Lead wrapped case	M29	Add \$404.00 per lockset
Half trim (for ML2010, ML2020, ML2022, ML2024, ML2029, ML2030, ML2032, ML2052, ML2053, ML2055, ML2056, ML2057, ML2058, ML2059, ML2062, ML2065 only) supplied with inside trim only	M30*	Deduct \$40.00 per lockset
Working trim only	M31	See pages 74 thru 90
Latch Hold Back 42, 51, 52, 55, 57 functions	LHB	Add \$62.00 per lockset
HPSK Positive Pull Stop Kit (813F068)		Add \$26.00
HPSK "PUSH" & "PULL" Identification (non-handed)	M38	\$37.00
HPSK Security Lever (not available on non-keyed functions)	M111	No Charge

* Not available with BHSS trim. Requires special application for BLSS, HSS, and HPSK trim.

** All levers provided in a powder coat finish will be supplied with an abrasive coating.

Thumbturn Options

Specify door thickness	Specify Quick Code	Add or Deduct
Ergonomic	M34 ²	Add \$22.00 per TT
Decorative	MT1	No Charge
Decorative square	MT2	No Charge
Decorative cylinder	MT3	No Charge

MT1

MT2

MT3

Notes:

1. Not available with Vineyard™ or Muséo® levers.

2. M34 is not available with M19N, M19VN or M19SN.

Note: Thumbturn backplate will match shape of rose chosen (i.e. round or square)

Indicator Options

Description	Specify Quick Code	Add or Deduct
Single Indicator Outside - Unlocked/Locked - Green/Red	V10	Add \$170.00 per lockset
Single Indicator Outside - Vacant/Occupied - Green/Red	V20	Add \$170.00 per lockset
Single Indicator Outside - Icons Only - Green/Red	V30	Add \$170.00 per lockset
Single Indicator Outside - Unlocked/Locked - White/Red	V40	Add \$170.00 per lockset
Single Indicator Outside - Vacant/Occupied - White/Red	V50	Add \$170.00 per lockset
Single Indicator Outside - Icons Only - White/Red	V60	Add \$170.00 per lockset
Single Indicator Inside - Unlocked/Locked - Green/Red	V01	Add \$170.00 per lockset
Single Indicator Inside - Icons Only - Green/Red	V03	Add \$170.00 per lockset
Single Indicator Inside - Unlocked/Locked - White/Red	V04	Add \$170.00 per lockset
Single Indicator Inside - Icons Only - White/Red	V06	Add \$170.00 per lockset
Double Indicator - Unlocked/Locked - Green/Red (Outside) Unlocked/Locked - Green/Red (Inside)	V11	Add \$340.00 per lockset
Double Indicator - Vacant/Occupied - Green/Red (Outside) Unlocked/Locked - Green/Red (Inside)	V21	Add \$340.00 per lockset
Double Indicator - Icons Only - Green/Red (Outside) Icons Only - Green/Red (Inside)	V33	Add \$340.00 per lockset
Double Indicator - Unlocked/Locked - White/Red (Outside) Unlocked/Locked - White/Red (Inside)	V44	Add \$340.00 per lockset
Double Indicator - Vacant/Occupied - White/Red (Outside) Unlocked/Locked - White/Red (Inside)	V54	Add \$340.00 per lockset
Double Indicator - Icons Only - White/Red (Outside) Icons Only - White/Red (Inside)	V66	Add \$340.00 per lockset
Single Indicator Outside - Secure/Unsecure - Green/Red (Sectional trim only)	M19S	Add \$185.00 per lockset
Single Indicator Outside - Vacant/Occupied - Green/Red (Sectional trim only)	M19V	Add \$185.00 per lockset
Single Indicator Inside - Secure/Unsecure - Green/Red (Sectional trim only)	M19N	Add \$185.00 per lockset
Double Indicator - Secure/Unsecure - Green/Red (Outside) Secure/Unsecure - Green/Red (Inside), (Sectional trim only)	M19SN	Add \$370.00 per lockset
Double Indicator - Vacant/Occupied - Green/Red (Outside) Secure/Unsecure - Green/Red (Inside) (Sectional trim only)	M19VN	Add \$370.00 per lockset
Outside Engraving with "Lock" and Directional Arrow	EMA	Add \$62.00 per lockset
Inside Engraving with "Lock" and Directional Arrow	EMB	Add \$62.00 per lockset
Engraving Both Sides with "Lock" and Directional Arrow	EMC	Add \$124.00 per lockset

French Options for V Series Indicators:

Description	Specify Quick Code	Add or Deduct
Single Indicator Outside - Ouvert/Fermé - Green/Red	V10F	Add \$170.00 per lockset
Single Indicator Outside - Libre/Occupée - Green/Red	V20F	
Single Indicator Inside - Ouvert/Fermé - Green/Red	V01F	Add \$340.00 per lockset
Double Indicator - Ouvert/Fermé - Green/Red (outside) Ouvert/Fermé - Green/Red (inside)	V11F	
Double Indicator - Ouvert/Fermé - Green/Red (outside) Libre/Occupée - Green/Red (inside)	V21F	

Sectional Trim Retrofit Kits for V Series Indicators (for M19 indicator refer to parts pages)

Description	Model #	List Price
Keyed Functions	ML190	\$280.00
Cointurn for Emergency Override	ML193	\$280.00
Thumbturn	ML194	\$280.00
No Input - Blank	ML197	\$280.00

NOTES:

When ordering sectional trim retrofit kits, specify finish, hand and V code required. i.e. ML190 x RH x 626 x V01. Kits accommodate indicators on one side of the door only. If indicators are required for both sides, 2 kits must be ordered as required by function. Add for indicator does not apply.

For escutcheon retrofit kits, specify function, trim, hand, finish and V code required X M31 option. See pages 70 thru 108 for pricing, add for indicator also applies.

Ordering Examples:

Function	Lever	Rose	Hand	Finish	Options
ML2002	NS	A	RH	626	V01

Double cylinder classroom intruder function x sectional trim x single indicator inside – Unlocked/Locked – Green/Red.

Function	Lever	Escutcheon	Hand	Finish	Options
ML2060	NS	VN	RH	626	V21 x EMB

Privacy function x escutcheon trim x double indicator – Vacant/Occupied – Green/Red (Outside) Unlocked/Locked – Green/Red (Inside) x inside engraving with "lock" and directional arrow.

NOTES:

- M19 series indicators are not available with BHSS or BLSS trims.
- V series indicators are not available with BHSS, BLSS, HSS or HPSK trims.
- EMA, EMB and EMC are only for use with V series indicators, for all other engraving, please refer to custom engraving options.
- Contact customer service for other available or custom indicator wording and/or colors.

Indicators and directional arrow engraving are available with the following functions:

ML2002, ML2003, ML2011, ML2012, ML2013, ML2017, ML2020, ML2022, ML2024, ML2029, ML2030, ML2040, ML2048, ML2049, ML2059, ML2060, ML2062, ML2065, ML2067, ML2068, ML2069, ML2072, ML2073, ML2075, ML2082, ML2092, ML20608 x NAC x SEC x PHR, ML20609 x NAC x SEC x PHR.

Please refer to the ML2000 Series catalog for more information.

MicroShield® Healthcare Hardware	116
Cylindrical Locks	
CLX3300 Series with BHSS Trim	117
CLX3300 Series Cylinder and Miscellaneous Options	118
Mortise Locks	
ML2000 Series with BHSS Trim	119
ML2000 Series with BLSS Trim	120
ML2000 Series with HSS Trim	121
ML2000 Series with HPSK Trim	122
ML2000 Series Cylinder and Miscellaneous Options	126
Tubular Locks	
HP3000 Series with HPSK Trim	129
HP3000 Series Miscellaneous Options	130

MicroShield®

Look for the *MicroShield* icon.

MicroShield®

As part of their promise to provide innovative solutions to their customers, certain ASSA ABLOY Group brands offer the MicroShield® technology, a silver-based antimicrobial coating designed to inhibit the growth of bacteria.

MicroShield® is a registered trademark of ASSA ABLOY Access and Egress Hardware Group, Inc.

Product	Trim	MicroShield® Coated Components
Healthcare Hardware	BHSS, BLSS, HSS, HPSK	Knobs/Levers, roses and/or escutcheons

AVAILABLE FINISHES

- MicroShield® is available on 626 and 630. Other finishes available by Special Product Application Request Form only.
- Specify 626C (satin chrome plated) or 630C (satin stainless steel) when ordering.
- MicroShield® coating will be applied over 626 and 630 finishes. All components will match 626.

Note: MicroShield® coating will only be applied to "high touch" components.

HOW TO ORDER

Product	How to Order
Mortise Locks	ML2055 x BHSS x 630C x RHR

Description	Add
Cylindrical Locks & Mortise Locks	Add \$99.00

Cylindrical Locks



Standard Features

Handing

Handed – must specify

Door Thickness

1-3/4" – 2"

Backset

2-3/4"

Strike

ANSI curved lip
4-7/8" x 1-1/4" x 1-1/4" lip
to center

Cylinder

Brass, 6-pin, L4 keyway, 0-bitted

Keys

Two nickel silver keys

Case Quantity

2

Case Weight

30 lbs



BHSS

Lever: Cast
Escutcheon: Cast

Ordering Examples

Stock Order

Quantity	Series/Function	Trim	Finish	Hand
100	CLX3355	BHSS	630	RHR

Contract/Detailed Order

Quantity	Keyset	Series/Function	Trim	Finish	Hand	Strike	Misc. Options	Cylinder and Keying
24	AA1	CLX3355	BHSS	630	RHR	SA112	M17	7P-VKC3

Product Number	Function	Description	630
CLX3310	Non-Keyed	Passage	\$2,022.00
CLX3330		Privacy	\$2,150.00
CLX3351	Single Cylinder	Entrance	\$2,286.00
CLX3355		Classroom	
CLX3357		Storeroom	
CLX3361		Entrance	
CLX3375	Double Cylinder	Corridor/Dormitory	\$2,389.00
CLX3332		Institution	\$2,424.00
CLX3382	Store Door		
CLX33903*	Electrified	Fail Safe	\$2,777.00
CLX33905*		Fail Secure	

Note: Units are handed and are not field reversible. Lock handing must be specified on order.

***ElectroLynx®**

As part of their promise to provide innovative, fast and effective, and higher security solutions to their customers, ASSA ABLOY Group companies offer ElectroLynx, a universal quick-connect system that simplifies the electrification of the door opening. ElectroLynx® is a registered trademark of ASSA ABLOY, Inc.

Cylinder Options

Description	Specify Quick Code	Add or Deduct
Conventional 6-pin	(standard)	No Charge
Conventional 7-pin	7P	Add \$2.00 per cylinder
Less Cylinder(s)	LC	Deduct \$120.00 per cylinder
LFIC		
LFIC 6-pin	C6	Add \$112.00 per cylinder
LFIC 6-pin Less Core	CL6	No Charge
LFIC 6-pin with Temporary Construction Core (Red)	CT6R	Add \$112.00 per cylinder
LFIC 6-pin with Temporary Construction Core (Blue)	CT6B	Add \$112.00 per cylinder
LFIC 6-pin with Temporary Construction Core (Green)	CT6G	Add \$112.00 per cylinder
LFIC 6-Pin Disposable Core	CT6D	No Charge
LFIC 7-pin	C7	Add \$114.00 per cylinder
LFIC 7-pin Less Core	CL7	No Charge
LFIC 7-pin with Temporary Construction Core (Red)	CT7R	Add \$114.00 per cylinder
LFIC 7-pin with Temporary Construction Core (Blue)	CT7B	Add \$114.00 per cylinder
LFIC 7-pin with Temporary Construction Core (Green)	CT7G	Add \$114.00 per cylinder
LFIC 7-Pin Disposable Core	CT7D	No Charge
SFIC (all lever designs)		
SFIC 6-pin	C6S	Add \$101.00 per cylinder
SFIC 6-pin with Temporary Construction Core (Blue)	CT6SB	Add \$101.00 per cylinder
SFIC 6-pin or 7-pin Temporary Disposable core	CTSD	No Charge
SFIC 7-pin	C7S	Add \$101.00 per cylinder
SFIC 7-pin with Temporary Construction Core (Blue)	CT7SB	Add \$101.00 per cylinder
Security		
Security	HS	Add \$167.00 per cylinder
Security LFIC	CHS	Add \$279.00 per cylinder
Access 3		
Access 3® Patented Fixed Core	AP	No Charge
Access 3® Security Fixed Core	AS	Add \$84.00 per cylinder
Access 3® High Security Fixed Core	AHS	Add \$120.00 per cylinder
Access 3® Patented LFIC	ACP	Add \$112.00 per cylinder
Access 3® Security LFIC	ACS	Add \$196.00 per cylinder
Access 3® High Security LFIC	ACHS	Add \$232.00 per cylinder
Pyramid		
Pyramid Security Fixed Core	PS	Add \$90.00 per cylinder
Pyramid Security LFIC	PCS	Add \$196.00 per cylinder
Pyramid High Security Fixed Core	PHS	Add \$131.00 per cylinder
Pyramid High Security LFIC	PCHS	Add \$241.00 per cylinder
Pyramid with Temporary Construction Core	CTP	Add \$112.00 per cylinder
Pyramid Disposable Core	CTPD	No Charge
Pyramid LFIC Less Core	CLP	No Charge
Other		
Lockset furnished in Schlage® C Keyway	C	No Charge
Lockset furnished in Sargent® LA Keyway	LA	No Charge

Continued on next page

Cylinder Options (continued) & Keying Options*				
Description	Specify Quick Code		Add or Deduct	
Keying and Keys				
0-bitted with 2 Blank Keys	(standard)		No Charge	
Keyed Random	KR			
Construction Master Keyed ¹	CMK		Add \$16.00 per cylinder	
More than 2 Keys	KY# (e.g., KY6)		See page 33 - Cut Keys Section	
Master Keying				
Master keyed (all cylinders except CR8000, CR8020, CR8027, CR8200, CR8500, CR8600, CR8700)	MK		Add \$16.00 per cylinder	
Master keyed Pyramid (except CR8020, CR8027 LFIC cores)	MK			
Master keyed Security (including LFIC cylinder and core)	MK			
Master keyed Access 3 (except CR8500, CR8600, CR8700 LFIC cores)	MK			
Master keyed (CR8000, CR8020, CR8027, CR8200, CR8500, CR8600, CR8700)	MK-IC		No Charge	
Master keyed to customer bittings or sample key	MK-CB		Add \$16.00 per cylinder	
Visual Cylinder/Key Control (VKC)	Cylinders		Keys	
	Stamping	List Price	Stamping	List Price
VKC0 – No stamping except keyway designation (keys will be tagged)	No Stamping	No Charge	No Stamping	\$5/Cyl
VKC1 – Keys only	N/A	N/A	Keyset	No Charge
VKC2 – Cylinder and keys*	Keyset	\$4/Cyl	Keyset	No Charge
VKC3 – Cylinder*	Keyset	\$4/Cyl	Bittings	No Charge
All VKC, VDC, or VAC stamping codes that use an alternate symbol	Alternate Stamping	\$4/Cyl	Alternate Stamping	\$4/Cyl
Concealed Cylinder/Visual Key Control (CKC)	Cylinders		Keys	
	Stamping	List Price	Stamping	List Price
CKC2 – Cylinder and Keys*	Keyset	\$4/Cyl	Keyset	No Charge
CKC3 – Cylinders only*	Keyset	\$4/Cyl	Bittings	No Charge
All CKC, CDC, or CAC stamping codes that use an alternate symbol	Alternate Stamping	\$4/Cyl	Alternate Stamping	\$4/Cyl

*Cylinder face stamping not available for Access 3, Pyramid, or Security products

Notes:

1. CMK Construction master keying charge is in addition to master keying charge and is not available in interchangeable core, Access 3, Pyramid, or Security series.

*Double cylinder keying: unless otherwise specified, both cylinders of 32 functions will be keyed alike. If different keying is required, specify outside cylinder first, then inside cylinder. For key bows other than 10 and 90, specify 'KB' + bow number as Quick Code, e.g. KB12.

Door Thickness Options

Description	Specify Quick Code	Add or Deduct
1-3/4" - 2"	(standard)	No Charge

Backset Options

Description	Specify Quick Code	Add or Deduct
2-3/4"	B234 (standard)	No Charge
3-3/4"	B334	Add \$15.00 per lockset
5"	B500	Add \$24.00 per lockset

Strike Options* (to purchase strike separately, see catalog or parts manual for part no.)

Lip Length	ANSI Curved Lip Specify Quick Code	Curved Lip Box Specify Quick Code	Full Lip Specify Quick Code	Add or Deduct
1"	SA100	SC100		No Charge
1-1/8"	SA118	SC118	SF118	
1-1/4"	SA114 (standard)	SC114		
1-3/8"	SA138	SC138		
1-1/2"	SA112	SC112		
1-3/4"	SA134	SC134		Add \$17.00 per lock
2"	SA200	SC200		
2-1/4"	SA214	SC214		
2-1/2"	SA212	SC212		
2-3/4"	SA234	SC234		
3"	SA300	SC300		

*If door thickness is standard or has been specified and no special door or frame condition exist, then only the first two characters of the optional strike Quick Code must be specified (e.g. "SC").
The correct lip length will be determined by our order entry system based on the standard or specified door thickness.

Miscellaneous Options

Description	Specify Quick Code	Add or Deduct
Torx® head screws (Standard)	M04	No Charge
Less cylinder, with tailpiece for Schlage® 6-pin fixed core cylinder (all designs)	M06	No Charge
Lever to accept 6 or 7-pin SFIC (all designs)	M08	No Charge
Lever to accept SARGENT® 6-pin fixed core cylinder (all designs)	M09	No Charge
1-1/8" latch front, rounded corners	M13	Add \$5.00 per latch
ANSI wrought strike box	M17	No Charge
Lead lining	M28	Add \$271.00 per lockset
Lever to accept Schlage® LFIC	M69	No Charge
Request to Exit (REX) Switch (Available with CLX33900 and all mechanic functions except dummy)	M92	\$302.00
Rigid outside lever when locked	M200	No Charge
Less cylinder, with tailpiece for ASSA ABLOY ACCENTRA™ 6-pin fixed core cylinder (all designs)	YC	
Less cylinder, with tailpiece for ASSA ABLOY ACCENTRA™ 7-pin fixed core cylinder (all designs)	YC7	

Mortise Locks



Standard Features

Handing

Handed – must specify

Door Thickness

1-3/4"

Backset

2-3/4"

Warranty

10 Years

Strike

ANSI curved lip

4-7/8" x 1-1/4" x 1-1/4" lip to center

Cylinder

Brass, 6-pin, L4 keyway, 0-bitted

Keys

Two nickel silver keys

Case Quantity

2

Case Weight

30 lbs

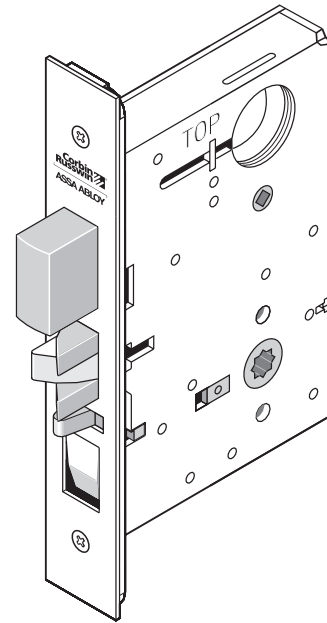

Ordering Example:

Stock Order

Quantity	Series/Function	Trim	Finish	Hand
100	ML2055	BLSS	630	RHR

Contract/Detailed Order

Quantity	Keyset	Series/Function	Trim	Finish	Hand	Strike	Misc. Options	Cylinder and Keying
24	AA1	ML2055	BHSS	630	RHR	SA200	M17-M29	C7-VKC3

Lever Design: BHSS

BHSS

Lever: Cast
Escutcheon: Cast

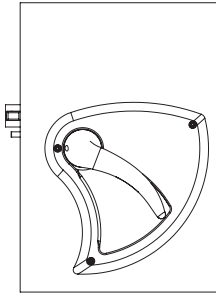

Function	Product No.	Description	630
Non-Keyed	ML2010	Passage	\$2,559.00
	ML2020	Privacy	\$2,661.00
	ML2030	Privacy	
	ML2060	Privacy	\$2,630.00
	ML2090	Full Active Dummy	\$2,207.00
Single Cylinder	ML2003	Classroom	\$2,727.00
	ML2051	Office	
	ML2055	Classroom	
	ML2056	Classroom HB	
	ML2057	Storeroom	
	ML2069	Institution Privacy	\$2,749.00
	ML2004	Classroom	
	ML2053	Entrance	
	ML2054	Entrance	
	ML2058	Entrance Holdback	
Single Cylinder with Deadbolt	ML2024	Entrance	\$2,791.00
	ML2048	Entrance	
	ML2049	Storeroom Deadbolt	
	ML2065	Dormitory	
	ML2059	Security Storeroom	
	ML2067	Apartment	
	ML2073	Classroom Security	
	ML2075	Entrance/Office	
ML2029	Hotel	\$2,840.00	
Double Cylinder	ML2002	Classroom Intruder	\$2,857.00
	ML2032	Institution	
	ML2042	Entrance	
	ML2052	Classroom Intruder	
Double Cylinder with Deadbolt	ML2022	Store Door	\$2,921.00
	ML2062	Intruder Deadbolt	
	ML2072	Classroom Security Intruder	
	ML2082	Dormitory	
	ML2092	Security Institution	
Single Cylinder	ML20906	Fail Safe/Fail Secure	\$3,169.00
	ML20914		
No Cylinder Override	ML20907	Fail Safe/Fail Secure	\$2,858.00
	ML20915		
Double Cylinder	ML20932	Fail Safe/Fail Secure	\$3,305.00
	ML20987		
Single Cylinder	ML20606	NAC Fail Safe/Fail Secure	\$3,398.00
	ML20608		\$3,494.00
No Cylinder Override	ML20607	NAC Fail Safe/Fail Secure	\$3,086.00
	ML20609		\$3,184.00
Full Working Trim	M31	No cylinder; includes thumbturn lever	\$2,058.00

Lever Design: BLSS

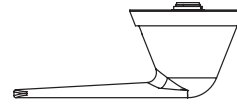
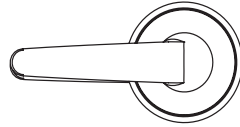

BLSS

Lever: Cast
Rose: Wrought

Function	Product No.	Description	630
Non-Keyed	ML2010	Passage	\$2,481.00
	ML2020	Privacy	\$2,583.00
	ML2030	Privacy	
	ML2060	Privacy	\$2,552.00
	ML2090	Full Active Dummy Trim	\$2,129.00
Single Cylinder	ML2003	Classroom	\$2,649.00
	ML2051	Office	
	ML2055	Classroom	
	ML2056	Classroom HB	
	ML2057	Storeroom	
	ML2069	Institution Privacy	\$2,671.00
	ML2004	Classroom	
	ML2053	Entrance	
	ML2054	Entrance	
	ML2058	Entrance	
Single Cylinder with Deadbolt	ML2024	Entrance	\$2,713.00
	ML2048	Entrance	
	ML2049	Storeroom Deadbolt	
	ML2059	Security Storeroom	
	ML2065	Dormitory	\$2,762.00
	ML2067	Apartment	
	ML2073	Classroom Security	
	ML2075	Classroom	
Double Cylinder	ML2002	Classroom Intruder	\$2,779.00
	ML2032	Institution	
	ML2042	Entrance	
	ML2052	Classroom	
Double Cylinder with Deadbolt	ML2022	Store Door	\$2,843.00
	ML2062	Intruder	
	ML2072	Classroom	
	ML2082	Dormitory	
	ML2092	Security Institution	
Single Cylinder	ML20906	Fail Safe/Fail Secure	\$3,091.00
	ML20914		
No Cylinder Override	ML20907	Fail Safe/Fail Secure	\$2,780.00
	ML20915		
Double Cylinder	ML20932	Fail Safe/Fail Secure	\$3,227.00
	ML20987		
Single Cylinder	ML20606	NAC Fail Safe/Fail Secure	\$3,320.00
	ML20608		\$3,416.00
No Cylinder Override	ML20607	NAC Fail Safe/Fail Secure	\$3,008.00
	ML20609		\$3,106.00
Full Working Trim	M31	No cylinder; includes thumbturn lever	\$1,980.00

Knob Design: HSS

HSS Knob: Brass



Function	Product No.	Description	630 ²	
Non-Keyed	ML2010	Passage	\$2,253.00	
	ML2020	Privacy	\$2,760.00	
	ML2060	Privacy	\$2,725.00	
	ML2090	Full Active Dummy Trim	\$2,289.00	
Single Cylinder	ML2003	Classroom	\$2,826.00	
	ML2051	Office		
	ML2055	Classroom		
	ML2056	Classroom HB		
	ML2057	Storeroom		
	ML2069	Inst. Privacy		
		ML2004	Classroom	\$2,848.00
		ML2053	Entrance	
		ML2054	Entrance	
		ML2058	Entrance	
		ML2068	Privacy	
	Single Cylinder with Deadbolt	ML2024	Entrance	\$2,890.00
ML2048				
Double Cylinder	ML2002	Classroom Intruder	\$2,956.00	
	ML2032	Institution		
	ML2042	Entrance		
	ML2052	Classroom		
Double Cylinder with Deadbolt	ML2022	Store Door	\$3,020.00	
	ML2092	Security Inst		
Deadlock	ML2011	Single Cylinder	\$879.00	
	ML2012	Double Cylinder	\$1,009.00	
	ML2013	Cylinder x Thumbturn	\$916.00	
	ML2017	Classroom Function Cylinder x Thumbturn		
Single Cylinder	ML20906	Fail Safe/Fail Secure	\$3,271.00	
	ML20914			
No Cylinder Override	ML20907	Fail Safe/Fail Secure	\$3,135.00	
	ML20915			
Double Cylinder	ML20932	Fail Safe/Fail Secure	\$3,408.00	
	ML20987			

Notes:

1. Sectional lever trim x HSS available.
2. 619 finish provided to match 630 finish.

Lever Design: HPSK

HPSK
Lever: Cast
Rose: Wrought

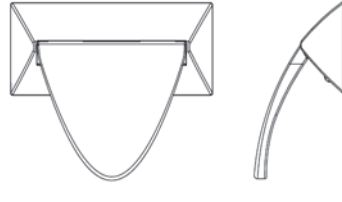

Function	Product No.	Description	630
Non-Keyed	ML2010	Passage	\$1,592.00
	ML2020	Privacy	\$1,665.00
	ML2030	Privacy	
	ML2060	Privacy	\$1,629.00
	ML2090	Full Active Dummy Trim	\$1,630.00
Single Cylinder	ML2003	Classroom	\$1,731.00
	ML2051	Office	
	ML2055	Classroom	
	ML2056	Classroom	
	ML2057	Storeroom	
	ML2069	Institution Privacy	\$1,753.00
	ML2004	Classroom	
	ML2053	Entrance	
	ML2054	Entrance	
	ML2058	Entrance Holdback	
Single Cylinder with Deadbolt	ML2068	Privacy or Apartment	\$1,795.00
	ML2024	Entrance	
	ML2048	Entrance	
	ML2065	Dormitory	
	ML2059	Security Storeroom	
	ML2067	Apartment	
	ML2073	Classroom Security	
	ML2075	Entrance/Office	
ML2029	Hotel	\$1,843.00	
Double Cylinder	ML2002	Classroom Intruder	\$1,861.00
	ML2032	Institution	
	ML2042	Entrance	
	ML2052	Classroom Intruder	
	ML2087	Security Vestibule	
Double Cylinder with Deadbolt	ML2022	Store Door	\$1,925.00
	ML2062	Intruder Deadbolt	
	ML2072	Classroom Security Intruder	
	ML2082	Dormitory	
	ML2092	Security Institution	
Single Cylinder	ML20906	Fail Safe/Fail Secure	\$2,125.00
	ML20914		
No Cylinder Override	ML20907	Fail Safe/Fail Secure	\$1,987.00
	ML20915		
Double Cylinder	ML20932	Fail Safe/Fail Secure	\$2,262.00
	ML20987		
Full Working Trim	M31	No cylinder, includes thumbturn lever	\$913.00

Part of a continuum of Safer2Open™ low-touch and touchless door hardware solutions from ASSA ABLOY.

Cylinder & Keying Options

Description	Specify Quick Code	Add or Deduct
Conventional 6-pin	(standard)	No Charge
Conventional 7-pin	7P	Add \$2.00 per cylinder
Less Standard Cylinder	LC	Deduct \$130.00 per cylinder
LFIC		
LFIC 6-pin	C6	Add \$112.00 per cylinder
LFIC 6-pin Less Core	CL6	No Charge
LFIC 6-pin with Temporary Construction Core (Red)	CT6R	Add \$112.00 per cylinder
LFIC 6-pin with Temporary Construction Core (Blue)	CT6B	Add \$112.00 per cylinder
LFIC 6-pin with Temporary Construction Core (Green)	CT6G	Add \$112.00 per cylinder
LFIC 6-pin with Temporary Disposable Core	CT6D	No Charge
LFIC 7-pin	C7	Add \$114.00 per cylinder
LFIC 7-pin Less Core	CL7	Add \$2.00 per cylinder
LFIC 7-pin with Temporary Construction Core (Red)	CT7R	Add \$114.00 per cylinder
LFIC 7-pin with Temporary Construction Core (Blue)	CT7B	Add \$114.00 per cylinder
LFIC 7-pin with Temporary Construction Core (Green)	CT7G	Add \$114.00 per cylinder
LFIC 7-pin with Temporary Disposable Core	CT7D	Add \$2.00 per cylinder
SFIC		
SFIC 6-pin	C6S	Add \$101.00 per cylinder
SFIC 6-pin with Less Core	CLS6	No Charge
SFIC 6-pin with Temporary Construction Core (Blue)	CT6SB	Add \$101.00 per cylinder
SFIC 6-pin with SFIC disposable temporary core	CT6SD	No Charge
SFIC 7-pin	C7S	Add \$101.00 per cylinder
SFIC 7-pin with Less Core	CLS7	No Charge
SFIC 7-pin with Temporary Construction Core (Blue)	CT7SB	Add \$101.00 per cylinder
SFIC 7-pin with SFIC disposable temporary core	CT7SD	No Charge
Security		
Security ⁴	HS	Add \$171.00 per cylinder
Security LFIC ^{1,4}	CHS	Add \$279.00 per cylinder
Access 3		
Access 3 Patented	AP	No Charge
Access 3 Security	AS	Add \$84.00 per cylinder
Access 3 High Security, UL 437	AHS	Add \$120.00 per cylinder
Access 3 LFIC Patented	ACP	Add \$112.00 per cylinder
Access 3 LFIC Security	ACS	Add \$196.00 per cylinder
Access 3 LFIC High Security, UL 437	ACHS	Add \$232.00 per cylinder
Pyramid		
Pyramid Security Fixed Core ²	PS	Add \$90.00 per cylinder
Pyramid Security LFIC	PCS	Add \$196.00 per cylinder
Pyramid High Security Fixed Core	PHS	Add \$135.00 per cylinder
Pyramid High Security LFIC	PCHS	Add \$241.00 per cylinder
Pyramid LFIC with Temporary Construction Core ³	CTP	Add \$112.00 per cylinder
Pyramid LFIC with Temporary Disposable Core ³	CTPD	No Charge
Pyramid LFIC Less Core ²	CLP	No Charge

Notes:

1. CHS ordered with CT6 option no charge.
2. Pyramid series and LFIC-7 pin are not available in ML2029 function.
3. Refer to Key construction core program, pg. 63 for example of CTP option pricing.
4. For existing systems only.

Cylinder & Keying Options* (continued)

Description	Specify Quick Code		Add or Deduct	
0-Bitted with two blank keys ⁵	STDKEY		No Charge	
Keyed Random ⁴	KR		No Charge	
Master keyed (all cylinders except 8000, 8020, 8027, 8200)	MK		Add \$16.00 per cylinder	
Master keyed Pyramid	MK		Add \$16.00 per cylinder	
Master keyed Security (including LFIC cylinder and core)	MK		Add \$16.00 per cylinder	
Master keyed (8000, 8020, 8027, 8200)	MK-IC		No Charge	
Master keyed to customer bittings or sample key	MK-CB		Add \$16.00 per cylinder	
Construction master keyed ^{1,2}	CMK		Add \$16.00 per cylinder	
More than 2 keys per lock	KY# (e.g., KY6)		See page 33 - Cut Keys Section	
Visual Cylinder/Key Control (VKC)	Cylinders		Keys	
	Stamping	List Price	Stamping	List Price
VKC0 – No stamping except keyway designation (keys will be tagged)	No Stamping	No Charge	No Stamping	\$5/Cyl
VKC1 – Keys only	N/A	N/A	Keyset	No Charge
VKC2 – Cylinder and keys*	Keyset	\$4/Cyl	Keyset	No Charge
VKC3 – Cylinder*	Keyset	\$4/Cyl	Bittings	No Charge
All VKC, VDC, or VAC stamping codes that use an alternate symbol	Alternate Stamping	\$4/Cyl	Alternate Stamping	\$4/Cyl
Concealed Cylinder/Visual Key Control (CKC)	Cylinders		Keys	
	Stamping	List Price	Stamping	List Price
CKC2 – Cylinder and Keys*	Keyset	\$4/Cyl	Keyset	No Charge
CKC3 – Cylinders only*	Keyset	\$4/Cyl	Bittings	No Charge
All CKC, CDC, or CAC stamping codes that use an alternate symbol	Alternate Stamping	\$4/Cyl	Alternate Stamping	\$4/Cyl

*Cylinder face stamping not available for Access 3, Pyramid, or Security products

*Double Cylinder Keying: Unless otherwise specified, both cylinders of ML2012, 2022, 2032, 2052, 2062, 2072, 2082, 2092 function locks will be keyed alike. The inside cylinder of 42 function locks will be keyed to the master key(s) only, while the outside cylinder will include the change key. If different is required, specify outside cylinder first, then inside cylinder. For key bows other than 10 and 90, specify "KB" + bow number as Quick Code, e.g. KB12. No extra charge.

Notes:

1. CMK Construction master keying charge is in addition to master keying charge.
2. CMK Construction master keying is not available in interchangeable core, Access 3, Pyramid, or Security series.
3. Pyramid series is not available keyed random.
4. Security series is not available 0-bitted.

Strike Options*

(To purchase strike separately, see catalog or parts manual for part no.)

Lip Length	ANSI Straight Lip – Specify Quick Code	ANSI Curved Lip – Specify Quick Code	Add or Deduct
7/8"	SS078	N/A	No Charge
1-1/8"	(standard)	N/A	
1-1/4"	SS114	SA114	
1-3/8"	SS138	SA138	
1-1/2"	SS112	SA112	
1-3/4"	SS134	SA134	Add \$17.00 per lock
2"	SS200	SA200	
2-1/4"	SS214	SA214	
2-1/2"	SS212	SA212	
2-3/4"	SS234	SA234	
3"	SS300	SA300	

* If door thickness is standard or has been specified and no special door or frame condition exist, then only the first two characters of the optional strike Quick Code must be specified (e.g. "SA").
The correct lip length will be determined by our order entry system based on the standard or specified door thickness.

Door Thickness with Locksets Mortised on Center

Door Thickness	Specify Quick Code	Add or Deduct
1-3/4" (standard)	—	No Charge
2"	D200	
2-1/4"	D214	

Miscellaneous Options

Description	Specify Quick Code	Add or Deduct
Spanner head screws	M02	Add \$30.00 per lockset
Torx® head screws (Standard)	M04	No Charge
ANSI wrought strike box	M17	No Charge
Lead wrapped case	M29	Add \$404.00 per lockset
Latch Hold Back 42, 51, 52, 55, 57 functions	LHB	Add \$62.00 per lockset
HPSK Positive Pull Stop Kit (813F068)		Add \$26.00
HPSK "PUSH" & "PULL" Identification (non-handed)	M38	\$37.00
HPSK Security Lever (not available on non-keyed functions)	M111	No Charge

Tubular Locks



Standard Features

Handing

Passage (HP3010) function is non-handed
Privacy (HP3020) function is handed

Door Thickness

1-3/4" (44mm) standard.
Optional door thicknesses available

Backset (5" – Standard)

5" (127mm) standard.
Optional: 2-3/4" (70mm) and 7" (177mm)

Strike

ANSI curved lip strike standard,
4-7/8" x 1-1/4" x 1-1/4" lip to center.

Optional strikes, lip lengths and ANSI
wrought strike box available

Latchbolt

Brass, 1/2" (13mm) throw

Covers

Cast stainless steel

Paddles

Cast stainless steel



Ordering Example

Stock Order

Series/Function	Trim	Finish	Hand*
HP3010	HPSK	630	RH

*Passage (HP3010) function is non-handed and privacy (HP3020) function is handed.

Function	Description	630
HP3010	Passage	\$680.00
HP3020	Privacy	\$883.00

Part of a continuum of Safer2Open™ low-touch and touchless door hardware solutions from ASSA ABLOY.

Strike Options

Lip to Center	ANSI Curved Lip. Specify	Curved Lip Box. Specify	Full Lip. Specify	Add or Deduct
1" (25mm)	SA100	SC100		No Charge
1-1/8" (29mm)	SA118	SC118		
1-1/4" (32mm)	(standard)	SC114	SF114*	
1-3/8" (35mm)	SA138	SC138		
1-1/2" (38mm)	SA112	SC112		
1-3/4" (44mm)	SA134	SC134		Add \$17.00 per lock
2" (51mm)	SA200	SC200		
2-1/4" (57mm)	SA214	SC214		
2-1/2" (28mm)	SA212	SC212		
2-3/4" (70mm)	SA234	SC234		
3" (76mm)	SA300	SC300		

* Specify SFR114 for rounded corner.

Door Thickness Options

Description	Specify Quick Code	Add or Deduct
1-3/4" (44mm)	(standard)	No Charge
2" (51mm)	D200	

Backset Options

Description	Specify Quick Code	Add or Deduct
2-3/4" (70mm)	B234	No Charge
5" (127mm)	(standard)	
7" (177mm)	B700	Add \$7.00 per lockset

Miscellaneous Options

Description	Specify Quick Code	Add or Deduct
Spanner head screws	M02	Add \$30.00 per lockset
Torx® head screws	M04	Add \$36.00 per lockset
Latch front, rounded corners	M13	Add \$5.00 per latch
ANSI wrought strike box	M17	No Charge
Lead lining. Specify Push or Pull side.	M28	Add \$428.00 per lockset
"PUSH & PULL" Identification*	M38	Add \$37.00
Retrofit Kit (part no. 791F39)		Add \$83.00
HP3000 Positive Pull Stop Kit (813F068)		Add \$26.00

MicroShield® Cylindrical Locksets Finishes, How to Order, Pricing	132
TL3700 Muséo Series Tubular Locksets:	
TL3700 Series: Muséo Georgia, Jackson, Marc, Salvador Levers & Inspire Trim:	133
TL3700 Series: Muséo Georgia, Jackson, Josef, Laszlo, Marc, Salvador Levers & Roses	134
TL3700 Series: Muséo Josef, Georges Levers & Roses	135
TL3700 Series: Muséo Piet Levers & Roses	136
TL3700 Series: Options	137
Grade 1 Vandal Resistant Cylindrical Lever Locksets CL3100 Series:	
CL3100 Series Standard Features, Ordering Examples	138
CL3100 Series Lever Designs	139
CL3100 Series Cylinder Options	140
CL3100 Series Keying Options	141
CL3100 Series Door Thickness, Backset, Strike Options	142
CL3100 Series Miscellaneous Options	143
Grade 1 Heavy-Duty Cylindrical Lever Locksets CLX3300 Series:	
CLX3300 Series Standard Features & Ordering Examples	144
CLX3300 Series Lever Designs	145
CLX3300 Series Indicator (NVSL)	146
CLX3300 Series Cylinder Options	147
CLX3300 Series Keying Options	148
CLX3300 Series Door Thickness, Backset, Strike Options	149
CLX3300 Series Miscellaneous Options	150
Grade 2 Standard-Duty Lever Locksets CL3800 Series:	
CL3800 Series Standard Features & Ordering Options	151
CL3800 Series Lever Designs	152
CL3800 Series Cylinder & Keying Options	153
CL3800 Series Door Thickness, Backset, Strike, Miscellaneous Options	154
Grade 1 Cylindrical Knob Locksets CK4300 Series:	
CK4300 Series Standard Features & Ordering Example	155
CK4300 Series Knob Designs, Cylinder Keying Options	156
CK4300 Series Strike, Backset, Door Thickness, Miscellaneous Options	157
Grade 2 Cylindrical Knob Locksets CK4800 Series:	
CK4800 Series Standard Features & Ordering Example	158
CK4800 Series Knob Designs, Cylinder & Keying Options, Backset Options	159
CK4800 Series Strike, Miscellaneous Options	160

MicroShield®

Look for the *MicroShield* icon.

TL3700
CL3100
CLX3300
CL3800

MicroShield®

As part of their promise to provide innovative solutions to their customers, certain ASSA ABLOY Group brands offer the MicroShield® technology, a silver-based antimicrobial coating designed to inhibit the growth of bacteria.

MicroShield® is a registered trademark of ASSA ABLOY Access and Egress Hardware Group, Inc.

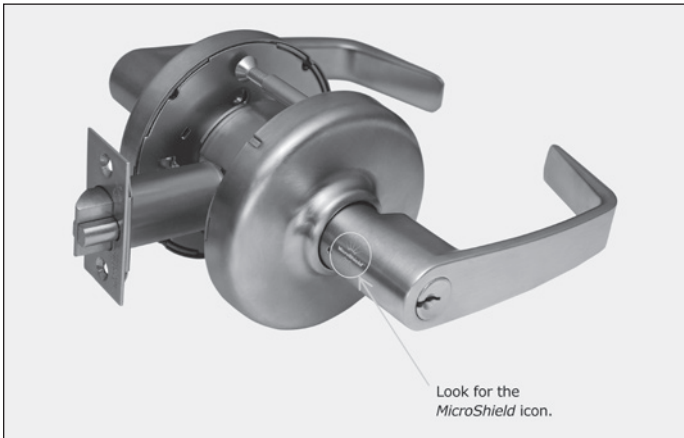

Product	Series	MicroShield® Coated Components
Cylindrical Locks	CL3100, CLX3300, and CL3800 Series	Levers*, roses

AVAILABLE FINISHES

- MicroShield® is available on 619 and 626. Other finishes available by Special Product Application Request Form only.
- Specify 619C (satin nickel plated) or 626C (satin chrome plated) when ordering.
- MicroShield® coating will be applied over 619 and 626 finishes. All components will match 626.

* MicroShield® coating will only be applied to "high touch" components.

HOW TO ORDER

Product	How to Order
Cylindrical Locks	CLX3355 x NZD x 626C

Description	Add
Cylindrical Locks	Add \$99.00

Tubular Locksets

TL3700 Series: Muséo Levers and Inspire™ Roseless Trim

USA & Canada Prices Effective March 3, 2025



contemporary trim to complement the interior design of your next project

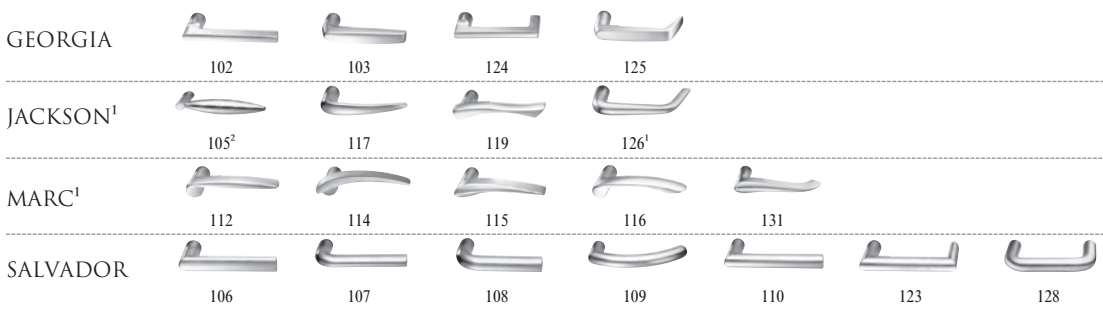

¹ Handed: specify hand when ordering
² Contact factory for current lead time

613E	Dark Oxidized Satin Bronze - Equivalent	605	Bright Brass, Clear Coated
626	Satin Chromium Plated	606	Satin Brass, Clear Coated
BSP	Black Suede Powder Coat	611	Bright Bronze, Clear Coated
WSP	White Suede Powder Coat	612	Satin Bronze, Clear Coated
		613	Dark Oxidized Satin Bronze, Oil Rubbed
		613L	Dark Oxidized Satin Bronze, Clear Coated
		618	Bright Nickel Plated
		619	Satin Nickel Plated
		625	Bright Chromium Plated
		629*	Bright Stainless Steel
		630*	Satin Stainless Steel
		722	Black Oxidized Bronze, Oil Rubbed

Function

Function	Price	Price
TL3710 Passage Set	\$449.00	\$459.00
TL3710A Passage Set-3 Hour	\$456.00	\$466.00
TL3720 Privacy Set	\$479.00	\$489.00
TL3720A Privacy Set-3 Hour	\$486.00	\$496.00
TL3750 Single Lever Pull-Through Bolted	\$233.00	\$238.00
TL3770 Double Lever Pull	\$370.00	\$380.00
TL3780 Communicating Set	\$449.00	\$459.00
TL3780A Communicating Set-3 Hour	\$456.00	\$466.00

Ordering Example Details

TL3710 Passage: Non-Keyed tubular lock
 102J Georgia Family Lever, J Collar
 626 Satin Chrome Finish
 LH Left Handed

Complete Lockset

Quantity	Series/Function	Trim	Finish	Hand
24	TL3710	102J	626	LH

*629 and *630 finish options are Not available for all Muséo levers. Please refer to page 22 for availability.



Experience a safer and more open world

Tubular Locksets

TL3700 Series: Muséo Levers and Roses

USA & Canada Prices Effective March 3, 2025

contemporary trim to complement the interior design of your next project



GEORGIA						 V ROSE U ROSE T ROSE E2 ROSE ³	
JACKSON ¹							
JOSEF							
LASZLO							
MARC ¹							
SALVADOR							
WING		GOTHIC					

¹Handed: specify hand when ordering

²Contact factory for current lead time

³**CAUTION:** Cannot retrofit on existing cylindrical lock door preps with through-bolt holes outside the 2-1/8" bored hole (Ex. CLX3300 & CL3800).

613E	Dark Oxidized Satin Bronze - Equivalent	605	Bright Brass, Clear Coated
626	Satin Chromium Plated	606	Satin Brass, Clear Coated
BSP	Black Suede Powder Coat	611	Bright Bronze, Clear Coated
WSP	White Suede Powder Coat	612	Satin Bronze, Clear Coated
		613	Dark Oxidized Satin Bronze, Oil Rubbed
		613L	Dark Oxidized Satin Bronze, Clear Coated
		618	Bright Nickel Plated
		619	Satin Nickel Plated
		625	Bright Chromium Plated
		629*	Bright Stainless Steel
		630*	Satin Stainless Steel
		722	Black Oxidized Bronze, Oil Rubbed

Function

TL3710	Passage Set	\$339.00	\$349.00
TL3710A	Passage Set-3 Hour	\$346.00	\$356.00
TL3720	Privacy Set	\$360.00	\$370.00
TL3720A	Privacy Set-3 Hour	\$367.00	\$377.00
TL3750	Single Lever Pull-Through Bolted	\$181.00	\$186.00
TL3750S	Single Lever Pull-Surface Mounted	\$150.00	\$155.00
TL3770	Double Lever Pull	\$284.00	\$294.00
TL3780	Communicating Set	\$339.00	\$349.00
TL3780A	Communicating Set-3 Hour	\$346.00	\$356.00

Ordering Example Details →

TL3710 Passage: Non-Keyed tubular lock
 111T Marc Lever, T-Rose
 626 Satin Chrome Finish
 LH Left Handed

Complete Lockset				
Quantity	Series/Function	Trim	Finish	Hand
24	TL3710	111T	626	LH

*629 and *630 finish options are Not available for all Muséo levers. Please refer to page 22 for availability.



Experience a safer and more open world

Tubular Locksets

TL3700 Series: Muséo Levers and Roses

USA & Canada Prices Effective March 3, 2025



contemporary levers to complement the interior design of your next project

JOSEF



GEORGES

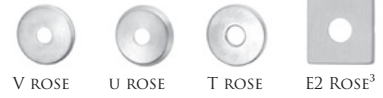

*Georges Levers 140 and 143 are not available for the following functions: TL3720 and TL3720A

¹Handed: specify hand when ordering

²Contact factory for current lead time

³**CAUTION:** Cannot retrofit on existing cylindrical lock door preps with through-bolt holes outside the 2-1/8" bored hole (Ex. CLX3300 & CL3800).

613E Dark Oxidized Satin Bronze - Equivalent
626 Satin Chromium Plated
BSP Black Suede Powder Coat
WSP White Suede Powder Coat

605 Bright Brass, Clear Coated
606 Satin Brass, Clear Coated
611 Bright Bronze, Clear Coated
612 Satin Bronze, Clear Coated
613 Dark Oxidized Satin Bronze, Oil Rubbed
613L Dark Oxidized Satin Bronze, Clear Coated
618 Bright Nickel Plated
619 Satin Nickel Plated
625 Bright Chromium Plated
629 Bright Stainless Steel
630 Satin Stainless Steel
722 Black Oxidized Bronze, Oil Rubbed

Function

Function	Price	Price
TL3710 Passage Set	\$501.00	\$511.00
TL3710A Passage Set-3 Hour	\$508.00	\$518.00
TL3720* Privacy Set	\$521.00	\$531.00
TL3720A* Privacy Set-3 Hour	\$528.00	\$538.00
TL3750 Single Lever Pull-Through Bolted	\$328.00	\$333.00
TL3750S Single Lever Pull-Surface Mounted	\$297.00	\$302.00
TL3770 Double Lever Pull	\$442.00	\$452.00
TL3780 Communicating Set	\$501.00	\$511.00
TL3780A Communicating Set-3 Hour	\$508.00	\$518.00

Ordering Example Details →

TL3710 Passage: Non-Keyed tubular lock
135E2 Josef Lever, E2 Rose
626 Satin Chrome Finish
LH Left Handed

Complete Lockset				
Quantity	Series/Function	Trim	Finish	Hand
24	TL3710	135E2	626	LH



Experience a safer and more open world

Tubular Locksets

TL3700 Series: Muséo Levers and Roses

USA & Canada Prices Effective March 3, 2025



contemporary trim to complement the interior design of your next project



*613E, BSP, WSP finishes are not available with 21M levers.



613E	Dark Oxidized Satin Bronze – Equivalent
629	Bright Stainless Steel
630	Satin Stainless Steel
BSP	Black Suede Powder Coat
WSP	White Suede Powder Coat

Function

TL3710	Passage Set	\$390.00
TL3710A	Passage Set - 3 Hour	\$397.00
TL3720	Privacy Set	\$413.00
TL3720A	Privacy Set - 3 Hour	\$420.00
TL3750	Single Lever Pull - Through Bolted	\$211.00
TL3750S	Single Lever Pull - Surface Mounted	\$180.00
TL3770	Double Lever Pull	\$330.00
TL3780	Communicating Set	\$390.00
TL3780A	Communicating Set - 3 Hour	\$397.00



613E	Dark Oxidized Satin Bronze – Equivalent
629	Bright Stainless Steel
630	Satin Stainless Steel
BSP	Black Suede Powder Coat
WSP	White Suede Powder Coat

Function

TL3710	Passage Set	\$511.00
TL3710A	Passage Set - 3 Hour	\$518.00
TL3720	Privacy Set	\$531.00
TL3720A	Privacy Set - 3 Hour	\$538.00
TL3750	Single Lever Pull - Through Bolted	\$333.00
TL3750S	Single Lever Pull - Surface Mounted	\$302.00
TL3770	Double Lever Pull	\$452.00
TL3780	Communicating Set	\$511.00
TL3780A	Communicating Set - 3 Hour	\$518.00

Ordering Example Details

TL3710	Passage: Non-Keyed tubular lock
23MU	Piet Family Lever - Wood Insert, U-Rose
29BH29	Lever Finish
	Wood insert with polished stainless steel (629) shank and polished stainless steel (629) grip
629	Lock Finish
LH	Left Handed

Complete Lockset

Quantity	Series/Function	Trim	Lever Finish	Lock Finish	Hand
2	TL3710	23MU	29BH29	629	LH

¹CAUTION: Cannot retrofit on existing cylindrical lock door preps with through-bolt holes outside the 2-1/8" bored hole (Ex. CLX3300 & CL3800).



Experience a safer and more open world

Door Thickness Options

Description	Specify Quick Code	Add or Deduct
1-3/8" (35mm) up to 1-3/4" (44mm)	D138	No Charge
1-3/4" (44mm) up to 2-1/4" (57mm)	(standard)	
2-1/4" (57mm) up to 2-1/2" (64mm)	D214	
Consult factory if over 2-1/2" (64mm)		

Backset Options

Description	Specify Quick Code	Add or Deduct
2-3/4"	B234 (standard)	No Charge
2-3/8" ¹	B238	

Strike Options

Lip Length	ANSI Curved Lip - Specify Quick Code	Curved Lip Box - Specify Quick Code	Full Lip Specify Quick Code	Full Lip Radius Corner Specify Quick Code	Add or Deduct
1"	SA100	SC100			No Charge
1-1/8"	SA118	SC118			
1-1/4"	SA114	SC114 (standard)	SF114	SFR114	
1-3/8"	SA138	SC138			
1-1/2"	SA112	SC112 ²			Add \$17.00 per lock
1-3/4"	SA134	SC134			
2"	SA200	SC200			
2-1/4"	SA214	SC214			
2-1/2"	SA212	SC212			
2-3/4"	SA234	SC234			
3"	SA300	SC300			

Miscellaneous Options

Description	Specify Quick Code	Add or Deduct
Latch front, rounded corners	M13	Add \$5.00 per latch
1" (25mm) latch front, square corners ³	M14	Add \$7.00 per lockset
1" (25mm) latch front, rounded corners	M15	Add \$5.00 per latch
ANSI wrought strike box	M17	Add \$7.00 per lockset

Notes:

- 1" front supplied standard
- Standard for D214
- Standard for 2-3/8" backset



**Grade 1 Vandal Resistant Cylindrical Lever Locksets
CL3100 Series**

USA & Canada Prices Effective March 3, 2025

Standard Features

Handing

Non-handed

Door Thickness

1-3/4" - 2" standard

Backset

2-3/4" standard

Strike

ANSI curved lip
4-7/8" x 1-1/4" x 1-1/4" lip to center

Cylinder

Brass, 6-pin, L4 keyway, 0-bitted

Keys

Two nickel silver keys

Case Quantity

6

Case Weight

32 lbs

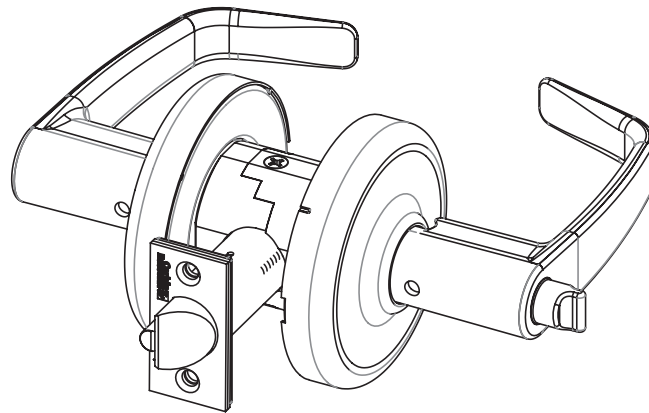

Ordering Examples

Stock Order

Quantity	Series/Function	Trim	Finish	Hand
100	CL3155	NZD	626	RHR

Split Finish Order

Quantity	Series/Function	Finish		Hand
		Outside	Inside	
12	CL3155	626	625	RHR

Note: Higher set price prevails

Contract/Detailed Order

Quantity	Keyset	Series/Function	Trim	Finish	Hand	Strike	Misc. Options	Cylinder and Keying
24	AA1	CL3155	NZD	626	RHR	SA112	M17	C6-VKC3

Lever Designs:  **Levers** **Roses**

Lever: Solid Cast Zinc
Rose: Brass

Newport



C ROSE

Armstrong

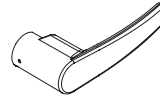

D ROSE

Princeton

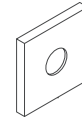
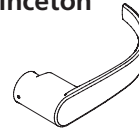

E ROSE



K ROSE

Function	Description		AZC, AZD, AZE, AZK, NZC, NZD, NZE, NZK, PZC, PZD, PZE, PZK	
			Finish: 613E, 626, BSP, WSP	Finish: 605, 606, 611, 612, 613, 613L, 618, 619, 625, 722
CL3110	Non-Keyed	Passage	\$771.00	\$787.00
CL3120		Privacy	\$877.00	\$893.00
CL3120H		Hospital Privacy		
CL3140NT		Exit Latch		
CL3150		Half Dummy	\$348.00	\$356.00
CL3170		Full Dummy	\$689.00	\$705.00
CL3180		Passage x blank plate	\$877.00	\$893.00
CL3151	Single Cylinder	Entrance	\$1,035.00	\$1,051.00
CL3155		Classroom		
CL3157		Storeroom		
CL3161		Entrance	\$1,057.00	\$1,073.00
CL3175		Corridor/dormitory	\$1,162.00	\$1,178.00
CL3193		Service Station		
CL3129		Hotel		
CL3132	Double Cylinder	Institution	\$1,214.00	\$1,230.00
CL3152		Classroom Intruder		
CL3162		Communicating		
CL3172		Public Toilet		

Grade 1 Vandal Resistant Cylindrical Lever Locksets CL3100 Series

USA & Canada Prices Effective March 3, 2025

Cylinder & Keying Options		
Description	Specify Quick Code	Add or Deduct
Conventional 6-pin	(standard)	No Charge
Conventional 7-pin	7P	Add \$2.00 per cylinder
Less Cylinder ⁴	LC	Deduct \$120.00 per cylinder
Less Hotel Cylinder	LC	Deduct \$138.00 per cylinder
LFIC		
LFIC 6-pin	C6	Add \$112.00 per cylinder
LFIC 6-pin Less Core ³	CL6	No Charge
LFIC 6-pin with Temporary Construction Core (Red) ³	CT6R	Add \$112.00 per cylinder
LFIC 6-pin with Temporary Construction Core (Blue) ³	CT6B	Add \$112.00 per cylinder
LFIC 6-pin with Temporary Construction Core (Green) ³	CT6G	Add \$112.00 per cylinder
LFIC 6-pin with Temporary Disposable Core	CT6D	No Charge
LFIC 7-pin	C7	Add \$114.00 per cylinder
LFIC 7-pin Less Core ³	CL7	No Charge
LFIC 7-pin with Temporary Construction Core (Red) ³	CT7R	Add \$114.00 per cylinder
LFIC 7-pin with Temporary Construction Core (Blue) ³	CT7B	Add \$114.00 per cylinder
LFIC 7-pin with Temporary Construction Core (Green) ³	CT7G	Add \$114.00 per cylinder
LFIC 7-pin with Temporary Disposable Core	CT7D	No Charge
SFIC³		
SFIC 6-pin	C6S	Add \$101.00 per cylinder
SFIC 6-pin with Temporary Construction Core (Blue)	CT6SB	Add \$101.00 per cylinder
SFIC 6-pin or 7-pin Temporary Disposable core	CTSD	No Charge
SFIC 7-pin	C7S	Add \$101.00 per cylinder
SFIC 7-pin with Temporary Construction Core (Blue)	CT7SB	Add \$101.00 per cylinder
Security		
Security ³	HS	Add \$167.00 per cylinder
Security LFIC ³	CHS	Add \$279.00 per cylinder
Access 3		
Access 3 Patented	AP	No Charge
Access 3 Security	AS	Add \$84.00 per cylinder
Access 3 High Security, UL 437	AHS	Add \$120.00 per cylinder
Access 3 LFIC Patented	ACP	Add \$112.00 per cylinder
Access 3 LFIC Security	ACS	Add \$196.00 per cylinder
Access 3 LFIC High Security, UL 437	ACHS	Add \$232.00 per cylinder
Pyramid		
Pyramid Security Fixed Core ³	PS	Add \$90.00 per cylinder
Pyramid Security LFIC ³	PCS	Add \$196.00 per cylinder
Pyramid High Security Fixed Core ³	PHS	Add \$131.00 per cylinder
Pyramid High Security LFIC ³	PCHS	Add \$241.00 per cylinder
Pyramid LFIC with Temporary Construction Core	CTP	Add \$112.00 per cylinder
Pyramid LFIC with Temporary Disposable Core	CTPD	No Charge
Pyramid LFIC Less Core	CLP	No Charge
Other		
Lockset furnished in Schlage® C Keyway ^{1,3}	C	No Charge
Lockset furnished in Sargent® LA Keyway ^{2,3}	LA	No Charge

Notes:

1. Available 0-bitted & key random (KR) only.
2. Available 0-bitted only.
3. Not available in CL3129 function.
4. CL3129 function is not available less cylinder.

Continued on next page

Cylinder & Keying Options* (continued)				
Description	Specify Quick Code		Add or Deduct	
0-Bitted with 2 blank keys	STDKEY		No Charge	
Keyed random	KR			
Construction master keyed ^{1, 2}	CMK		Add \$16.00 per cylinder	
More than 2 keys per lock	KY# (e.g., KY6)		See page 29 - Cut Keys Section	
Master Keying				
Master keyed (all cylinders except CR8000, CR8020, CR8027, CR8200, CR8500, CR8600, CR8700)	MK		Add \$16.00 per cylinder	
Master keyed Pyramid (except CR8020, CR8027 LFIC cores)	MK			
Master keyed Security (including LFIC cylinder and core)	MK			
Master keyed Access 3 (except CR8500, CR8600, CR8700 LFIC cores)	MK			
Master keyed (CR8000, CR8020, CR8027, CR8200, CR8500, CR8600, CR8700)	MK-IC		No Charge	
Master keyed to customer bittings or sample key	MK-CB		Add \$16.00 per cylinder	
Visual Cylinder/Key Control (VKC)	Cylinders		Keys	
	Stamping	List Price	Stamping	List Price
	VKC0 – No stamping except keyway designation (keys will be tagged)	No Stamping	No Charge	No Stamping
VKC1 – Keys only	N/A	N/A	Keyset	No Charge
VKC2 – Cylinder and keys*	Keyset	\$4/cyl	Keyset	No Charge
VKC3 – Cylinder*	Keyset	\$4/cyl	Bittings	No Charge
All VKC, VDC, or VAC stamping codes that use an alternate symbol	Alternate Stamping	\$4/cyl	Alternate Stamping	\$4/cyl
Concealed Cylinder/Visual Key Control (CKC)	Cylinders		Keys	
	Stamping	List Price	Stamping	List Price
	CKC2 – Cylinder and Keys*	Keyset	\$4/cyl	Keyset
CKC3 – Cylinders only*	Keyset	\$4/cyl	Bittings	No Charge
All CKC, CDC, or CAC stamping codes that use an alternate symbol	Alternate Stamping	\$4/cyl	Alternate Stamping	\$4/cyl

*Cylinder face stamping not available for Access 3, Pyramid, or Security products

Notes:

1. CMK Construction master keying charge is in addition to master keying charge.
2. CMK Construction master keying is not available in interchangeable core, Access 3, Pyramid, or Security series..

*Double cylinder keying: unless otherwise specified, both cylinders of 32, 52 and 62 functions will be keyed alike. The inside cylinder of 72 function will be keyed to the master key(s) only, while the outside cylinder will include the change key.

If different keying is required, specify outside cylinder first, then inside cylinder.

For key bows other than 10 and 90, specify 'KB' + bow number as Quick Code, e.g. KB12.

Grade 1 Vandal Resistant Cylindrical Lever Locksets CL3100 Series

USA & Canada Prices Effective March 3, 2025

Door Thickness Options

Description	Specify Quick Code	Add or Deduct
1-3/4" - 2"	(standard)	No Charge
Over 2" up to 2-1/4"	D214	

Backset Options

Description	Specify Quick Code	Add or Deduct
2-3/4"	B234 (standard)	No Charge
3-3/4"	B334	Add \$15.00 per lockset
5"	B500	Add \$24.00 per lockset

Strike Options² (to purchase strike separately, see catalog or parts manual for part no.)

Lip Length	ANSI Curved Lip - Specify Quick Code	Curved Lip Box - Specify Quick Code	Add or Deduct
1"	SA100	SC100	No Charge
1-1/8"	SA118	SC118	
1-1/4"	SA114 (standard)	SC114	
1-3/8"	SA138	SC138	
1-1/2"	SA112	SC112	
1-3/4"	SA134	SC134	Add \$17.00 per lock
2"	SA200	SC200	
2-1/4"	SA214	SC214	
2-1/2"	SA212	SC212	
2-3/4"	SA234	SC234	
3"	SA300	SC300	

^{1,2}If door thickness is standard or has been specified and no special door or frame condition exist, then only the first two characters of the optional strike Quick Code must be specified (e.g. "SC").
The correct lip length will be determined by our order entry system based on the standard or specified door thickness.

Miscellaneous Options		
Description	Specify Quick Code	Add or Deduct
Spanner head screws	M02	Add \$30.00 per lockset
Torx® head screws	M04	Add \$36.00 per lockset
Less cylinder and with tailpiece for Schlage® fixed core cylinder (AZ, NZ & PZ designs) ¹	M06	No Charge
Lever to accept 6 or 7-pin SFIC (AZ, NZ & PZ designs) ¹	M08	No Charge
Lever to accept Sargent® fixed core cylinder (AZ, NZ & PZ designs) ¹	M09	No Charge
Security Lever (not available on non-keyed functions)	M111	No Charge
3/4" throw fire latch x 2-3/4" backset (not available for CL3120, 29, 40, and 93 functions) <div style="display: flex; justify-content: space-between; margin-top: 5px;"> <div style="text-align: left;"> Finishes Available 605 606 626 </div> <div style="text-align: left;"> Matching Lock Finish 605, 611, 606, 612, 613, 613L, 722 613E, 618, 619, 625, 625, BSP, WSP </div> </div>	M16	Add \$142.00 per lockset
ANSI wrought strike box	M17	No Charge
Knurling outside and inside	M20*	Add \$212.00 per lockset
Knurling outside only	M21*	Add \$106.00 per lockset
Knurling inside only	M22*	Add \$106.00 per lockset
Abrasive coat outside and inside	M23	Add \$134.00 per lockset
Abrasive coat inside only	M24	Add \$67.00 per lockset
Abrasive coat outside only	M25	Add \$67.00 per lockset
Lead lining (roses)	M28	Add \$271.00 per lockset
Lever to accept Schlage® LFIC (AZ, NZ & PZ designs) ¹	M69	No Charge
Lever to accept ASSA ABLOY ACCENTRA™ 6-pin fixed core cylinder (NZ & PZ designs only) ¹	YC	
Lever to accept ASSA ABLOY ACCENTRA™ 7-pin fixed core cylinder (NZ & PZ designs only) ¹	YC7	
Lever to accept ASSA ABLOY ACCENTRA™ 6-pin LFIC (NZ & PZ designs only) ¹	YRC	
Lever to accept ASSA ABLOY ACCENTRA™ 7-pin LFIC (NZ & PZ designs only) ¹	YRC7	
STC 55 Acoustical Door Kit	M112	
Notes: * All levers provided in a powder coat finish will be supplied with an abrasive coating. 1. Not available in CL3129 function.		

**Grade 1 Heavy Duty Cylindrical Lever Locksets
CLX3300 Series**

USA & Canada Prices Effective March 3, 2025

Standard Features

Handing

Non-handed

Door Thickness

1-3/4" - 2"

Backset

2-3/4"

Strike

ANSI curved lip
4-7/8" x 1-1/4" x 1-1/4" lip to center

Cylinder

Brass, 6-pin, L4 keyway, 0-bitted

Keys

Two nickel silver keys

Case Quantity

6

Case Weight

32 lbs

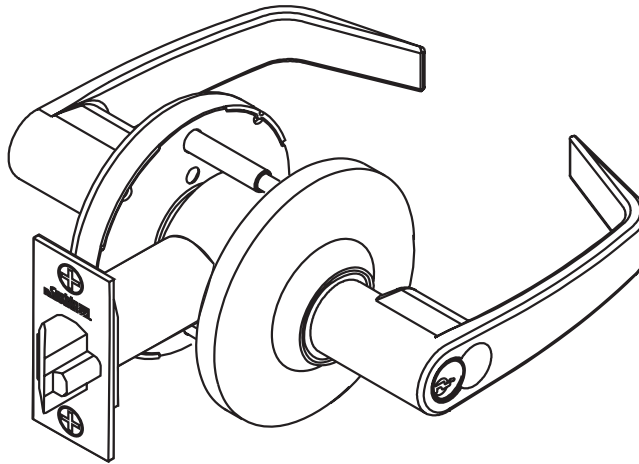

Ordering Examples

Stock Order

Quantity	Series/Function	Trim	Finish	Hand
100	CLX3355	NZD	626	RHR

Split Trim/Split Finish Order

Quantity	Series/Function	Trim		Finish		Hand
		Outside	Inside	Outside	Inside	
12	CLX3355	NZD	AZD	626	625	RHR

Contract/Detailed Order

Quantity	Keyset	Series/Function	Trim	Finish	Hand	Strike	Misc. Options	Cylinder and Keying
24	AA1	CLX3355	NZD	626	RHR	SA112	M17	C6-VKC3

Lever Designs: AZD, NZD, PZD, 102D, 106D, 123D, 124D



Lever: Solid Cast Zinc
Rose: Wrought Brass



AZD



NZD



PZD



102D



106D



123D



124D

Function	Description	AZD, NZD, PZD, 102D, 106D, 123D, 124D	
		Finish: 613E, 626, BSP, WSP	Finish: 605, 606, 611, 612, 613, 613L, 618, 619, 625, 722
CLX3310	Passage	\$683.00	\$699.00
CLX3380	Passage x Blank Plate		
CLX3390	Passage x Turnpiece	\$814.00	\$830.00
CLX3320	Privacy		
CLX3320H	Hospital Privacy	\$814.00	\$830.00
CLX3320TO	Time Out Lock		
CLX3330	Privacy x Cointurn Release	\$814.00	\$830.00
CLX3340	Patio		
CLX3340NT	Exit Latch		
CLX3350	Half Dummy	\$296.00	\$304.00
CLX3370	Full Dummy	\$592.00	\$608.00
CLX3351	Entrance		
CLX3355	Classroom	\$953.00	\$969.00
CLX3357	Storeroom		
CLX3359	Storeroom or Public Restroom		
CLX3361	Entrance	\$972.00	\$988.00
CLX3375	Corridor/Dormitory		
CLX3376	Corridor/Dormitory (modified)	\$1,058.00	\$1,074.00
CLX3393	Service Station		
CLX3329	Hotel		
CLX3381	Classroom x Blank Plate	\$953.00	\$969.00
CLX3383	Storeroom x Blank Plate		
CLX3332	Institution		
CLX3352	Classroom Intruder		
CLX3362	Communicating	\$1,095.00	\$1,111.00
CLX3372	Public Toilet		
CLX3382	Store Door		
CLX33903*	Fail Safe	\$1,455.00	\$1,471.00
CLX33905*	Fail Secure		

***ElectroLynx®**

As part of their promise to provide innovative, fast and effective, and higher security solutions to their customers, ASSA ABLOY Group companies offer ElectroLynx, a universal quick-connect system that simplifies the electrification of the door opening. ElectroLynx® is a registered trademark of ASSA ABLOY, Inc.

Grade 1 Heavy Duty Cylindrical Lever Locksets CLX3300 Series

USA & Canada Prices Effective March 3, 2025 – Added 6/14/24

Lever Designs: NVSL 

Lever: Solid Cast Zinc
Rose: Wrought Brass



Note: When ordering VSL trim, indicator option code must also be specified.

NVSL

Function	Description	NVSL		
		Finish: 613E, 626, BSP, WSP	Finish: 605, 606, 611, 612, 613, 613L, 618, 619, 625, 722	
CLX3320	Non-Keyed	Privacy	\$814.00	\$830.00
CLX3320H		Hospital Privacy	\$814.00	\$830.00
CLX3330		Privacy x Cointurn Release	\$814.00	\$830.00
CLX3340		Patio		
CLX3351	Single Cylinder	Entrance	\$953.00	\$969.00
CLX3357		Storeroom		
CLX3361		Entrance	\$972.00	\$988.00
CLX3375		Corridor/Dormitory (indicator outside only)	\$1,058.00	\$1,074.00
CLX3393		Service Station		

Description	Specify Quick Code	Add or Deduct
Indicator Outside Only with Icons – Green/Red	V30	Add \$125 per lockset
Indicator Outside Only with Icons – White/Red	V60	
Indicator Inside Only with Icons – Green/Red	V03	
Indicator Inside Only with Icons – White/Red	V06	
Indicator Both Sides with Icons – Green/Red	V33	Add \$250 per lockset
Indicator Both Sides with Icons – White/Red	V66	Add \$250 per lockset

Cylinder Options		
Description	Specify Quick Code	Add or Deduct
Conventional 6-pin	(standard)	No Charge
Conventional 7-pin	7P	Add \$2.00 per cylinder
Less Cylinder(s)	LC	Deduct \$120.00 per cylinder
Less Hotel Cylinder	LC	Deduct \$138.00 per cylinder
LFIC		
LFIC 6-pin	C6	Add \$112.00 per cylinder
LFIC 6-pin Less Core ¹	CL6	No Charge
LFIC 6-pin with Temporary Construction Core (Red) ¹	CT6R	Add \$112.00 per cylinder
LFIC 6-pin with Temporary Construction Core (Blue) ¹	CT6B	Add \$112.00 per cylinder
LFIC 6-pin with Temporary Construction Core (Green) ¹	CT6G	Add \$112.00 per cylinder
LFIC 6-Pin Disposable Core ¹	CT6D	No Charge
LFIC 7-pin	C7	Add \$114.00 per cylinder
LFIC 7-pin Less Core ¹	CL7	No Charge
LFIC 7-pin with Temporary Construction Core (Red) ¹	CT7R	Add \$114.00 per cylinder
LFIC 7-pin with Temporary Construction Core (Blue) ¹	CT7B	Add \$114.00 per cylinder
LFIC 7-pin with Temporary Construction Core (Green) ¹	CT7G	Add \$114.00 per cylinder
LFIC 7-Pin Disposable Core ¹	CT7D	No Charge
SFIC (all lever designs)¹		
SFIC 6-pin	C6S	Add \$101.00 per cylinder
SFIC 6-pin with Temporary Construction Core (Blue)	CT6SB	Add \$101.00 per cylinder
SFIC 6-pin or 7-pin Temporary Disposable core	CTSD	No Charge
SFIC 7-pin ¹	C7S	Add \$101.00 per cylinder
SFIC 7-pin with Temporary Construction Core (Blue)	CT7SB	Add \$101.00 per cylinder
Security		
Security ¹	HS	Add \$167.00 per cylinder
Security LFIC ¹	CHS	Add \$279.00 per cylinder
Access 3		
Access 3® Patented Fixed Core	AP	No Charge
Access 3® Security Fixed Core	AS	Add \$84.00 per cylinder
Access 3® High Security Fixed Core	AHS	Add \$120.00 per cylinder
Access 3® Patented LFIC ¹	ACP	Add \$112.00 per cylinder
Access 3® Security LFIC ¹	ACS	Add \$196.00 per cylinder
Access 3® High Security LFIC ¹	ACHS	Add \$232.00 per cylinder
Pyramid		
Pyramid Security Fixed Core ¹	PS	Add \$90.00 per cylinder
Pyramid Security LFIC ¹	PCS	Add \$196.00 per cylinder
Pyramid High Security Fixed Core ¹	PHS	Add \$131.00 per cylinder
Pyramid High Security LFIC ¹	PCHS	Add \$241.00 per cylinder
Pyramid with Temporary Construction Core ¹	CTP	Add \$112.00 per cylinder
Pyramid Disposable Core ¹	CTPD	No Charge
Pyramid LFIC Less Core ¹	CLP	No Charge
Other		
Lockset furnished in Schlage® C Keyway	C	No Charge
Lockset furnished in Sargent® LA Keyway	LA	No Charge
Notes: 1. Not available in CLX3329 function		<i>Continued on next page</i>

Cylinder Options (continued) & Keying Options*

Description	Specify Quick Code	Add or Deduct		
Keying and Keys				
0-bitted with 2 Blank Keys	(standard)	No Charge		
Keyed Random	KR			
Construction Master Keyed ²	CMK	Add \$16.00 per cylinder		
More than 2 Keys	KY# (e.g., KY6)	See page 29 - Cut Keys Section		
Master Keying				
Master keyed (all cylinders except CR8000, CR8020, CR8027, CR8200, CR8500, CR8600, CR8700)	MK	Add \$16.00 per cylinder		
Master keyed Pyramid (except CR8020, CR8027 LFIC cores)	MK			
Master keyed Security (including LFIC cylinder and core)	MK			
Master keyed Access 3 (except CR8500, CR8600, CR8700 LFIC cores)	MK			
Master keyed (CR8000, CR8020, CR8027, CR8200, CR8500, CR8600, CR8700)	MK-IC	No Charge		
Master keyed to customer bittings or sample key	MK-CB	Add \$16.00 per cylinder		
Visual Cylinder/Key Control (VKC)	Cylinders		Keys	
	Stamping	List Price	Stamping	List Price
VKC0 – No stamping except keyway designation (keys will be tagged)	No Stamping	No Charge	No Stamping	\$5/Cyl
VKC1 – Keys only	N/A	N/A	Keyset	No Charge
VKC2 – Cylinder and keys*	Keyset	\$4/Cyl	Keyset	No Charge
VKC3 – Cylinder*	Keyset	\$4/Cyl	Bittings	No Charge
All VKC, VDC, or VAC stamping codes that use an alternate symbol	Alternate Stamping	\$4/Cyl	Alternate Stamping	\$4/Cyl
Concealed Cylinder/Visual Key Control (CKC)	Cylinders		Keys	
	Stamping	List Price	Stamping	List Price
CKC2 – Cylinder and Keys*	Keyset	\$4/Cyl	Keyset	No Charge
CKC3 – Cylinders only*	Keyset	\$4/Cyl	Bittings	No Charge
All CKC, CDC, or CAC stamping codes that use an alternate symbol	Alternate Stamping	\$4/Cyl	Alternate Stamping	\$4/Cyl

*Cylinder face stamping not available for Access 3, Pyramid, or Security products

Notes:

1. Not available in CLX3329 function.
2. CMK Construction master keying charge is in addition to master keying charge and is not available in interchangeable core, Access 3, Pyramid, or Security series.

*Double cylinder keying: unless otherwise specified, both cylinders of 32, 62, 72 and 82 functions will be keyed alike. The inside cylinder of 52 function will be keyed to the master key(s) only, while the outside cylinder will include the change key. If different keying is required, specify outside cylinder first, then inside cylinder. For key bows other than 10 and 90, specify 'KB' + bow number as Quick Code, e.g. KB12.

Door Thickness Options

Description	Specify Quick Code	Add or Deduct
1-3/8" (adapter plates)	D138*	\$36.00
1-3/4" - 2"	(standard)	No Charge
2" VSL trim only	D200	
Over 2" up to 2-1/4"	D214	

*Lock provided with adapter (spacer) plates. Supplied with 2-3/8" backset latch x square corner x 1" front. Refer to CLX3300 catalog for door thickness range for VSL trim.

Backset Options

Description	Specify Quick Code	Add or Deduct
2-3/8"	B238**	No Charge
2-3/4"	B234 (standard)	
3-3/4"	B334	Add \$15.00 per lockset
5"	B500	Add \$24.00 per lockset

** Supplied with square corners x 1" front.

Strike Options* (to purchase strike separately, see catalog or parts manual for part no.)

Lip Length	ANSI Curved Lip Specify Quick Code	Curved Lip Box Specify Quick Code	Full Lip Specify Quick Code	Add or Deduct
1"	SA100	SC100		No Charge
1-1/8"	SA118	SC118	SF118	
1-1/4"	SA114 (standard)	SC114		
1-3/8"	SA138	SC138		
1-1/2"	SA112	SC112		
1-3/4"	SA134	SC134		Add \$17.00 per lock
2"	SA200	SC200		
2-1/4"	SA214	SC214		
2-1/2"	SA212	SC212		
2-3/4"	SA234	SC234		
3"	SA300	SC300		

*If door thickness is standard or has been specified and no special door or frame condition exist, then only the first two characters of the optional strike Quick Code must be specified (e.g. "SC"). The correct lip length will be determined by our order entry system based on the standard or specified door thickness.

Miscellaneous Options

Description	Specify Quick Code	Add or Deduct
Split designs and split finishes	Outside Trim x Inside Trim	Higher set price prevails
Spanner head screws	M02	Add \$30.00 per lockset
Torx® head screws	M04	Add \$36.00 per lockset
Less cylinder, with tailpiece for Schlage® 6-pin fixed core cylinder (all designs)	M06	No Charge
Lever to accept 6 or 7-pin SFIC ² (all designs)	M08	No Charge
Lever to accept SARGENT® 6-pin fixed core cylinder (all designs)	M09	No Charge
1-1/8" latch front, rounded corners	M13	Add \$5.00 per latch
3/4" throw fire latch x 2-3/4" backset <div style="display: flex; justify-content: space-between;"> <div style="width: 30%;"> Finishes Available 605 606 626 </div> <div style="width: 40%;"> Matching Lock Finish 605, 611 606, 612, 613, 613L, 722 613E, 618, 619, 625, 626, BSP, WSP </div> </div>	M16	Add \$142.00 per lockset
ANSI wrought strike box	M17	No Charge
Knurling outside and inside (AZ, NZ, PZ only)	M20*	Add \$212.00 per lockset
Knurling outside only (AZ, NZ, PZ only)	M21*	Add \$106.00 per lockset
Knurling inside only (AZ, NZ, PZ only)	M22*	Add \$106.00 per lockset
Abrasive coat outside and inside (AZ, NZ, PZ only)	M23	Add \$134.00 per lockset
Abrasive coat inside only (AZ, NZ, PZ only)	M24	Add \$67.00 per lockset
Abrasive coat outside only (AZ, NZ, PZ only)	M25	Add \$67.00 per lockset
Lead lining	M28	Add \$271.00 per lockset
Lever to accept Schlage® LFIC ² (AZ, NZ, PZ, NVSL only)	M69	No Charge
Request to Exit (REX) Switch (Available with CLX33900 and all mechanical functions except dummy)	M92	\$302.00
Rigid outside lever when locked	M200	No Charge
Red Powder Coat Push/Turn Button	RPB	Add \$16.00 per lockset
Less cylinder, with tailpiece for ASSA ABLOY ACCENTRA™ 6-pin fixed core cylinder (all designs)	YC	No Charge
Less cylinder, with tailpiece for ASSA ABLOY ACCENTRA™ 7-pin fixed core cylinder (all designs)	YC7	
Lever to accept ASSA ABLOY ACCENTRA™ 6-pin LFIC, AZ, NZ, PZ, NVSL only	YRC	

Notes:

*All levers provided in a powder coat finish will be supplied with an abrasive coating.

Standard Features

Handing

Non-handed

Door Thickness

1-3/8" - 1-7/8"
Available in 2" - 2-1/4" upon request

Backset

2-3/4" standard

Strike

ANSI curved lip
4-7/8" x 1-1/4" x 1-1/4" lip to center

Cylinder

Brass, 6-pin, L4 keyway
0-bitted

Keys

Two nickel silver keys

Case Quantity

6

Case Weight

32 lbs

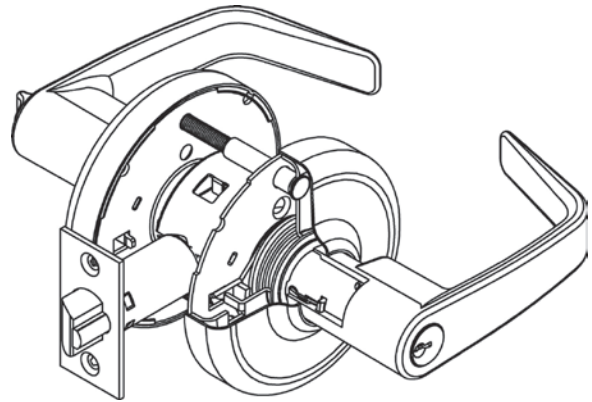

Ordering Examples

Stock Order

Quantity	Series/Function	Trim	Finish	Hand
100	CL3855	NZD	626	RHR

Split Trim/Split Finish Order

Quantity	Series/Function	Trim		Finish		Hand
		Outside	Inside	Outside	Inside	
12	CL3855	NZD	AZD	626	625	RHR

Contract/Detailed Order

Quantity	Keyset	Series/Function	Trim	Finish	Hand	Strike	Misc. Options	Cylinder and Keying
24	AA1	CL3855	NZD	626	RHR	SA112	M02	C6-VKC3

Lever Designs: AZD, NZD, PZD, 102D, 124D



Lever:

Solid Cast Zinc

Rose:

Wrought Brass



AZD



NZD



PZD



102D



124D

Function	Description	AZD, NZD, PZD, 102D, 124D	
		Finish: 613E, 626, BSP, WSP	Finish: 605, 606, 611, 612, 613, 613L, 618, 619, 625, 722
CL3810	Passage	\$330.00	\$346.00
CL3880	Passage x Blank Plate	\$355.00	\$371.00
CL3820	Privacy		
CL3850	Half Dummy		
CL3870	Full Dummy	\$345.00	\$361.00
CL3851	Entrance	\$423.00	\$439.00
CL3855	Classroom		
CL3857	Storeroom		
CL3861	Office		

Cylinder & Keying Options		
Description	Specify Quick Code	Add or Deduct
Conventional 6-pin	(standard)	No Charge
Conventional 7-Pin	7P	Add \$2.00 per cylinder
Less Standard Cylinder	LC	Deduct \$120.00 per cylinder
LFIC		
LFIC 6-pin	C6	Add \$112.00 per cylinder
LFIC 6-pin Less Core	CL6	No Charge
LFIC 6-pin with Temporary Construction Core (Red)	CT6R	Add \$112.00 per cylinder
LFIC 6-pin with Temporary Construction Core (Blue)	CT6B	Add \$112.00 per cylinder
LFIC 6-pin with Temporary Construction Core (Green)	CT6G	Add \$112.00 per cylinder
LFIC 6-pin with Temporary Disposable Core	CT6D	No Charge
LFIC 7-Pin	C7	Add \$114.00 per cylinder
LFIC 7-Pin Less Core	CL7	No Charge
LFIC 7-Pin with Temporary Construction Core (Red)	CT7R	Add \$114.00 per cylinder
LFIC 7-Pin with Temporary Construction Core (Blue)	CT7B	Add \$114.00 per cylinder
LFIC 7-Pin with Temporary Construction Core (Green)	CT7G	Add \$114.00 per cylinder
LFIC 7-Pin with Temporary Disposable Core	CT7D	No Charge
SFIC (all lever designs)		
SFIC 6-pin	C6S	Add \$101.00 per cylinder
SFIC 6-pin with Temporary Construction Core (Blue)	CT6SB	Add \$101.00 per cylinder
SFIC 6-pin or 7-pin Temporary Disposable core	CTSD	No Charge
SFIC 7-pin	C7S	Add \$101.00 per cylinder
SFIC 7-pin with Temporary Construction Core (Blue)	CT7SB	Add \$101.00 per cylinder
Security		
Security	HS	Add \$167.00 per cylinder
Security LFIC	CHS	Add \$279.00 per cylinder
Access 3		
Access 3 Patented	AP	No Charge
Access 3 Security	AS	Add \$84.00 per cylinder
Access 3 High Security, UL 437	AHS	Add \$120.00 per cylinder
Access 3 LFIC Patented	ACP	Add \$112.00 per cylinder
Access 3 LFIC Security	ACS	Add \$196.00 per cylinder
Access 3 LFIC High Security, UL 437	ACHS	Add \$232.00 per cylinder
Pyramid		
Pyramid Security Fixed Core ³	PS	Add \$90.00 per cylinder
Pyramid Security LFIC ³	PCS	Add \$196.00 per cylinder
Pyramid High Security Fixed Core ³	PHS	Add \$131.00 per cylinder
Pyramid High Security LFIC ³	PCHS	Add \$241.00 per cylinder
Pyramid LFIC with Temporary Construction Core	CTP	Add \$112.00 per cylinder
Pyramid LFIC with Temporary Disposable Core	CTPD	No Charge
Pyramid LFIC Less Core	CLP	No Charge
Other		
Lockset furnished in Schlage® C Keyway ¹	C	No Charge
Lockset furnished in SARGENT® LA Keyway ²	LA	No Charge
Keying and Keys		
0-bitted with 2 Blank Keys	(standard)	No Charge
Keyed Random	KR	
Construction master keyed ^{1, 2}	CMK	Add \$16.00 per cylinder
More than 2 Keys	KY# (e.g., KY6)	See page 29 - Cut Keys Section
Master Keying		
Master keyed (all cylinders except CR8000, CR8020, CR8027, CR8200, CR8500, CR8600, CR8700 LFIC cores)	MK	Add \$16.00 per cylinder
Master keyed Pyramid (except CR8020, CR8027 LFIC cores)	MK	
Master keyed Security (including LFIC cylinder and core)	MK	
Master keyed Access 3 (except CR8500, CR8600, CR8700 LFIC cores)	MK	
Master keyed (CR8000, CR8020, CR8027, CR8200, CR8500, CR8600, CR8700 LFIC cores)	MK-IC	No Charge
Master keyed to customer bittings or sample key	MK-CB	Add \$16.00 per cylinder
Notes:		Continued on next page.
1. Available 0-bitted & key random (KR) only.		
2. Available 0-bitted only.		
3. CMK Construction master keying charge is in addition to master keying charge.		
4. CMK Construction master keying is not available in interchangeable core, Access 3, Pyramid, or Security series.		
5. VKC2, VKC3, CKC3 are not available in Access 3, Pyramid or Security series.		
For key bows other than 10 and 90, specify "KB" + bow number as Quick Code, e.g. KB12. No extra charge.		

Cylinder Options (continued) & Keying Options*

VISUAL CYLINDER/KEY CONTROL:				
Description	Cylinders		Keys	
	Stamping	List Price	Stamping	List Price
VKC0 – No stamping except keyway designation (keys will be tagged)	No Stamping	No Charge	No Stamping	\$5/Cyl
VKC1 – Keys only	N/A	N/A	Keyset	No Charge
VKC2 – Cylinder and keys*	Keyset	\$4/Cyl	Keyset	No Charge
VKC3 – Cylinder*	Keyset	\$4/Cyl	Bittings	No Charge
All VKC, VDC, or VAC stamping codes that use an alternate symbol	Alternate Stamping	\$4/Cyl	Alternate Stamping	\$4/Cyl
CONCEALED CYLINDER/VISUAL KEY CONTROL:				
Description	Cylinders		Keys	
	Stamping	List Price	Stamping	List Price
CKC2 – Cylinder and Keys*	Keyset	\$4/Cyl	Keyset	No Charge
CKC3 – Cylinders only*	Keyset	\$4/Cyl	Bittings	No Charge
All CKC, CDC, or CAC stamping codes that use an alternate symbol	Alternate Stamping	\$4/Cyl	Alternate Stamping	\$4/Cyl

*Cylinder face stamping not available for Access 3, Pyramid, or Security products

Notes: 1. CMK Construction master keying charge is in addition to master keying charge.
 2. CMK construction master keying is not available in interchangeable core, Access 3, Pyramid, or Security series.
 **For key bows other than 10 and 90, specify 'KB' + bow number as Quick Code, e.g. KB12. No extra charge.

Backset Options

Description	Specify Quick Code	Add or Deduct
2-3/8"	B238'	No Charge
2-3/4"	B234 (standard)	
3-3/4"	B334	Add \$15.00 per lockset
5"	B500	Add \$24.00 per lockset

Door Thickness Options

Description	Specify Quick Code	Add or Deduct
1-3/8" — 1-7/8"	(standard)	No Charge
2" — 2-1/4"	D214	No Charge

Strike Options* (to purchase strike separately, see catalog or parts manual for part no.)

Lip Length	ANSI Curved Lip Specify Quick Code	Curved Lip Box Specify Quick Code	Full Lip Specify Quick Code	Full Lip Radius Corner Specify Quick Code	Add or Deduct
1"	SA100	SC100			No Charge
1-1/8"	SA118	SC118			
1-1/4"	SA114 (standard)	SC114	SF114	SFR114	
1-3/8"	SA138	SC138			
1-1/2"	SA112	SC112			
1-3/4"	SA134	SC134			Add \$17.00 per lock
2"	SA200	SC200			
2-1/4"	SA214	SC214			
2-1/2"	SA212	SC212			
2-3/4"	SA234	SC234			
3"	SA300	SC300			

*If door thickness is standard or has been specified and no special door or frame condition exist, then only the first two characters of the optional strike Quick Code must be specified (e.g. "SC"). The correct lip length will be determined by our order entry system based on the standard or specified door thickness.

Description	Specify Quick Code	Add or Deduct
Split designs and split finishes	Outside Trim x Inside Trim	Higher set price prevails
Spanner head screws	M02	Add \$30.00 per lockset
Torx® head screws	M04	Add \$36.00 per lockset
Less cylinder and with tailpiece for Schlage® fixed core cylinder (all designs)	M06	No Charge
Lever to accept 6 or 7-pin SFIC (all designs)	M08	No Charge
Lever to accept Sargent® fixed core cylinder (NZD & PZD designs only)	M09	No Charge
1-1/8" latch front, rounded corners	M13	Add \$5.00 per latch
1" latch front, square corners ¹	M14	Add \$7.00 per lockset
1" latch front, rounded corners	M15	Add \$5.00 per latch
ANSI wrought strike box	M17	No Charge
Knurling outside and inside	M20*	Add \$212.00 per lockset
Knurling outside only	M21*	Add \$106.00 per lockset
Knurling inside only	M22*	Add \$106.00 per lockset
Abrasive coat outside and inside only	M23	Add \$134.00 per lockset
Abrasive coat inside only	M24	Add \$67.00 per lockset
Abrasive coat outside only	M25	Add \$67.00 per lockset
1-1/8" latch front, square corners (standard for 2-3/4" and 5" backsets)	M32	No Charge
Lever to accept Schlage® LFIC (NZD & PZD designs only)	M69	No Charge

Notes: * All levers provided in a powder coat finish will be supplied with an abrasive coating.
 1. M14 and B238 (2-3/8" backset) standard with D138 (1-3/8" door thickness) option.

Standard Features

Handing

Field reversible

Door Thickness

1-3/4" - 2"

Backset

2-3/4"

Strike

ANSI curved lip 4-7/8" - 1-1/4" x
1-1/4" lip to center

Cylinder

Brass, 6-pin, L4 keyway
0-bitted

Keys

Two nickel silver keys

Case Quantity

10

Case Weight

32 lbs

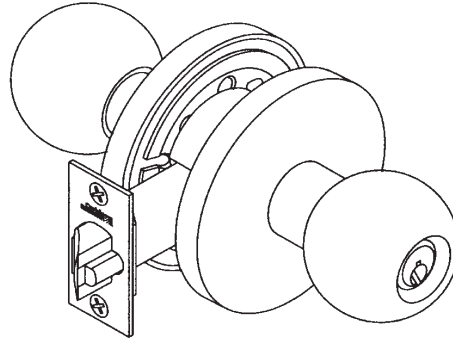

Ordering Example

Stock Order

Quantity	Series/Function	Trim	Finish	Hand
100	CK4355	GRD	630	RHR

Contract/Detailed Order

Quantity	Keypad	Series/Function	Trim	Finish	Hand	Strike	Misc. Options	Cylinder and Keying
24	AA1	CK4355	GRD	630	RHR	SA112	M02	VKC3

Knob Designs: GRD

Knob:
Wrought
Reinforced

Rose:
Wrought
Reinforced

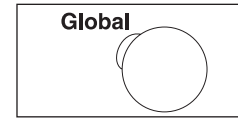

Function	Description		GRD
			Finish: 605, 613E, 630
CK4310	Non-Keyed	Passage	\$921.00
CK4320		Privacy	\$1,033.00
CK4350		Half Dummy	\$394.00
CK4351	Single Cylinder	Entrance	\$1,143.00
CK4355		Classroom	
CK4357		Storeroom	
CK4332	Double Cylinder	Institution	\$1,245.00

Cylinder Options

Description	Specify Quick Code	Add or Deduct
Conventional 6-pin	(standard)	No Charge
Less (1) Cylinder	LC	Deduct \$120.00 per cylinder
Access 3 Patented	AP	No Charge
Access 3 Security	AS	Add \$84.00 per cylinder
Access 3 High Security, UL 437	AHS	Add \$120.00 per cylinder
Pyramid Security Fixed Core	PS	Add \$90.00 per cylinder
Pyramid High Security Fixed Core	PHS	Add \$131.00 per cylinder
Security	HS	Add \$167.00 per cylinder

Keying Options*

Description	Specify Quick Code	Add or Deduct
0-Bitted with 2 blank keys	(standard)	No Charge
Keyed random	KR	
Master keyed	Specify keyset	Add \$16.00 per cylinder
Master keyed Pyramid	Specify keyset	Add \$16.00 per cylinder
Master keyed Security	Specify keyset	Add \$16.00 per cylinder
Master keyed	Specify keyset	No Charge
Master keyed to customer bittings or sample key	Specify keyset	Add \$16.00 per cylinder
Construction master keyed ^{1,2}	CMK	Add \$16.00 per cylinder
More than 2 keys per lock	KY# (e.g., KY6)	See page 29 - Cut Keys Section

VISUAL CYLINDER/KEY CONTROL:

Description	Cylinders		Keys	
	Stamping	List Price	Stamping	List Price
VKC0 – No stamping except keyway designation (keys will be tagged)	No Stamping	No Charge	No Stamping	\$5/key
VKC1 – Keys only	N/A	N/A	Keyset	No Charge
VKC2 – Cylinder and keys*	Keyset	\$4/cyl	Keyset	No Charge
VKC3 – Cylinder*	Keyset	\$4/cyl	Bittings	No Charge
All VKC, VDC, or VAC stamping codes that use an alternate symbol	Alternate Stamping	\$4/cyl	Alternate Stamping	\$4/cyl

CONCEALED CYLINDER/VISUAL KEY CONTROL:

Description	Cylinders		Keys	
	Stamping	List Price	Stamping	List Price
CKC2 – Cylinder and Keys*	Keyset	\$4/cyl	Keyset	No Charge
CKC3 – Cylinders only*	Keyset	\$4/cyl	Bittings	No Charge
All CKC, CDC, or CAC stamping codes that use an alternate symbol	Alternate Stamping	\$4/cyl	Alternate Stamping	\$4/cyl

*Cylinder face stamping not available for Access 3, Pyramid, or Security products

Notes:

1. CMK Construction master keying charge is in addition to master keying charge.
2. CMK Construction master keying is not available in interchangeable core, Access 3, Pyramid, or Security series.

*Double cylinder keying: unless otherwise specified, both cylinders of 32 functions will be keyed alike. If different keying is required, specify outside cylinder first, then inside cylinder. For key bows other than 10 and 90, specify "KB" + bow number as Quick Code, e.g. KB12. No extra charge.

Strike Options*

To purchase strike separately, see catalog or parts manual for part number.

Lip Length	ANSI Curved Lip - Specify Quick Code	Curved Lip Box - Specify Quick Code	Add or Deduct
1"	SA100	SC100	No Charge
1-1/8"	SA118	SC118	
1-1/4"	SA114 (standard)	SC114	
1-3/8"	SA138	SC138	
1-1/2"	SA112	SC112	
1-3/4"	SA134	SC134	Add \$17.00 per lock
2"	SA200	SC200	
2-1/4"	SA214	SC214	
2-1/2"	SA212	SC212	
2-3/4"	SA234	SC234	
3"	SA300	SC300	

*If door thickness is standard or has been specified and no special door or frame condition exist, then only the first two characters of the optional strike Quick code must be specified(e.g. "SC").
The correct lip length will be determined by our order entry system based on the standard or specified door thickness.

Backset Options

Description	Specify Quick Code	Add or Deduct
2-3/4"	B324 (standard)	No Charge

Door Thickness Options

Description	Specify Quick Code	Add or Deduct
1-3/4" - 2"	(standard)	No Charge

Miscellaneous Options

Description	Specify Quick Code	Add or Deduct
Spanner head screws	M02	Add \$30.00 per lockset
Torx® head screws	M04	Add \$36.00 per lockset
ANSI wrought strike box	M17	No Charge

Standard Features

Handing

Field reversible

Door Thickness

1-3/8" - 1-3/4"

Backset

2-3/4"

Strike

ANSI curved Lip 4-7/8" x 1-1/4"
x 1-1/4" lip to center

Cylinder

Brass, 6-pin, L4 keyway,
0-bitted

Keys

Two nickel silver keys

Case Quantity

12

Case Weight

18 lbs

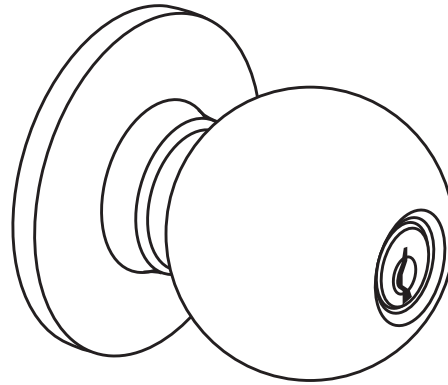

Ordering Example

Stock Order

Quantity	Series/Function	Trim	Finish	Hand
100	CK4851	GWC	626	RHR

Contract/Detailed Order

Quantity	Keyset	Series/Function	Trim	Finish	Hand	Strike	Misc. Options	Cylinder and Keying
24	AA1	CK4851	GWC	626	RHR	SA200	M17	VKC1

Knob Designs: GWC

Knob:
Wrought

Rose:
Wrought

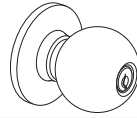

GWC

Function	Description		GWC
			Finish: 605, 613E, 626
CK4810	Non-Keyed	Passage	\$284.00
CK4820		Privacy	\$308.00
CK4850		Half Dummy	\$205.00
CK4851	Single Cylinder	Entrance	\$422.00
CK4855		Classroom	
CK4857		Storeroom	

Cylinder & Keying Options

Description	Specify Quick Code	Add or Deduct
Conventional 6-pin	(standard)	No Charge
Less cylinder	LC	Deduct \$120.00 per cylinder
Security		
Security	HS	Add \$167.00 per cylinder
Access 3®		
Access 3 Patented	AP	No Charge
Access 3 Security	AS	Add \$84.00 per cylinder
Access 3 High Security, UL 437	AHS	Add \$120.00 per cylinder
Pyramid		
Pyramid Security Fixed Core	PS	Add \$90.00 per cylinder
Pyramid High Security Fixed Core	PHS	Add \$131.00 per cylinder
Keying and Keys		
0-Bitted with 2 blank keys	(standard)	No Charge
Keyed random	KR	No Charge
Construction master keyed ¹	CMK	Add \$16.00 per cylinder
More than 2 keys per lock	KY# (e.g., KY6)	See page 29 - Cut Keys Section
Master Keying		
Master keyed to customer bittings or sample key	MK-CB	Add \$16.00 per cylinder
Conventional, Security, Pyramid and Access 3 cylinders	MK	

VISUAL CYLINDER/KEY CONTROL:

Description	Cylinders		Keys	
	Stamping	List Price	Stamping	List Price
VKC0 – No stamping except keyway designation (keys will be tagged)	No Stamping	No Charge	No Stamping	\$5/Cyl
VKC1 – Keys only	N/A	N/A	Keyset	No Charge
VKC2 – Cylinder and keys*	Keyset	\$4/Cyl	Keyset	No Charge
VKC3 – Cylinder*	Keyset	\$4/Cyl	Bittings	No Charge
All VKC, VDC, or VAC stamping codes that use an alternate symbol	Alternate Stamping	\$4/Cyl	Alternate Stamping	\$4/Cyl

CONCEALED CYLINDER/VISUAL KEY CONTROL:

Description	Cylinders		Keys	
	Stamping	List Price	Stamping	List Price
CKC2 – Cylinder and Keys*	Keyset	\$4/Cyl	Keyset	No Charge
CKC3 – Cylinders only*	Keyset	\$4/Cyl	Bittings	No Charge
All CKC, CDC, or CAC stamping codes that use an alternate symbol	Alternate Stamping	\$4/Cyl	Alternate Stamping	\$4/Cyl

*Cylinder face stamping not available for Access 3, Pyramid, or Security products

Notes: 1. CMK Construction master keying charge is in addition to master keying charge.
 2. CMK construction master keying is not available in interchangeable core, Access 3, Pyramid, or Security series.
 **For key bows other than 10 and 90, specify 'KB' + bow number as Quick Code, e.g. KB12. No extra charge.

Backset Options

Notes: 1. CMK Construction master keying charge is in addition to master keying charge.
 For key bows other than 10 and 90, specify "KB" + bow number as Quick Code, e.g. KB12. No extra charge.

Description	Specify Quick Code	Add or Deduct
2-3/8"	B238	No Charge
2-3/4"	B234 (standard)	

Strike Options*

To purchase strike separately, see catalog or parts manual for part no.

Lip Length	ANSI Curved Lip Specify Quick Code	Curved Lip Box Specify Quick Code	Full Lip Specify Quick Code	Add or Deduct
1"	SA100	SC100		No Charge
1-1/8"	SA118	SC118		
1-1/4"	SA114 (standard)	SC114	SF114	
1-3/8"	SA138	SC138		
1-1/2"	SA112	SC112		
1-3/4"	SA134	SC134		Add \$17.00 per lock
2"	SA200	SC200		
2-1/4"	SA214	SC214		
2-1/2"	SA212	SC212		
2-3/4"	SA234	SC234		
3"	SA300	SC300		

*If door thickness is standard or has been specified and no special door or frame condition exist, then only the first two characters of the optional strike Quick Code must be specified (e.g. "SC").

Miscellaneous Options

Description	Specify Quick Code	Add or Deduct
ANSI wrought strike box	M17	No Charge

Pre-Assembled Unit Locksets:

UT5200 Series Standard Features & Ordering Examples	162
UT5200 Series Lever Designs	163
UT5200 Series Cylinder Options	164
UT5200 Series Keying Options	165
UT5200 Series Strike, Miscellaneous Options	166

PL5000 Series Padlocks:

PL5000 Series Standard Features & Ordering Example	167
PL5000 Series Cylinder & Keying, Miscellaneous Options	168

DL2200 Series Cylindrical Deadlocks:

DL2200 Series Standard Features & Ordering Example	169
DL2200 Series Cylinder & Keying Options	170
DL2200 Series Strike, Door Thickness, Miscellaneous Options	171

DL3000 Series Cylindrical Deadlocks:

DL3000 Series Standard Features & Ordering Example	172
DL3000 Series Cylinder & Keying Options	173
DL3000 Series Strike, Door Thickness, Miscellaneous Options	174

DL3200 Series Cylindrical Deadlocks:

DL3200 Series Standard Features & Ordering Example	175
DL3200 Series Cylinder & Keying Options	176
DL3200 Series Strike, Door Thickness, Miscellaneous Options	177

DL4100 Series Mortise Deadlocks:

DL4100 Series Standard Features & Ordering Example	178
DL4100 Series Cylinder & Keying Options	179
DL4100 Series Strike, Door Thickness, Miscellaneous Options	180

Standard Features

Handing

Specify hand

Door Thickness

1-3/4" only

Backset

2-3/4" only

Strike

ANSI curved lip 4-7/8" x 1-1/4"
x 1-1/4" lip to center

Cylinder

Brass, 6-pin, L4 keyway,
0-bitted

Keys

Two nickel silver keys

Case Quantity

6
9

Case Weight

32 lbs

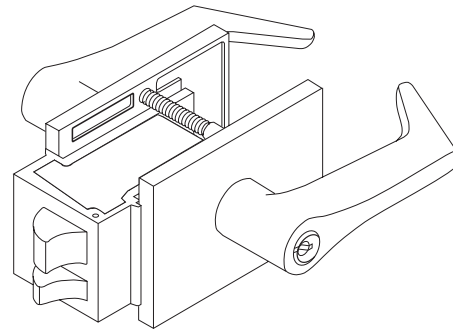

Now available with MicroShield® antimicrobial finish. Specify 626C finish (\$59.00 upcharge per lockset)

Ordering Example

Stock Order

Quantity	Series/Function	Trim	Finish	Hand
100	UT5251	ESE	626	RH

Split Trim/Split Finish Order

Quantity	Series/Function	Trim	Finish		Hand
			Outside	Inside	
12	UT5251	ESE	626	625	RHR

Contract/Detailed Order

Quantity	Keyset	Series/Function	Trim	Finish	Hand	Strike	Misc. Options	Cylinder and Keying
24	AA1	UT5251	ESE	626	RHR	SC200	M21	MR-VKC3

Lever Designs: ESE



Essex

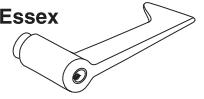

Lever:
Forged

Escutcheon:
Forged

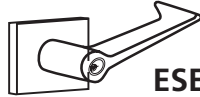

ESE

Function	Description		ESE
			Finish: 612, 613, 613E, 625, 626
UT5210	Non-keyed	Passage or Closet	\$2,181.00
UT5220		Privacy	\$2,292.00
UT5251	Single Cylinder	Entrance	\$2,410.00
UT5255		Classroom	
UT5257		Storeroom	
UT5282	Double Cylinder	Store Door	\$2,530.00

Cylinder Options		
Description	Specify Quick Code	Add or Deduct
Conventional 6-pin	(standard)	No Charge
Less Standard Cylinder	LC	Deduct \$120.00 per cylinder
LFIC		
LFIC 6-pin	C6	Add \$112.00 per cylinder
LFIC 6-pin Less Core	CL6	No Charge
LFIC 6-pin with Temporary Construction Core (Red)	CT6R	Add \$112.00 per cylinder
LFIC 6-pin with Temporary Construction Core (Blue)	CT6B	Add \$112.00 per cylinder
LFIC 6-pin with Temporary Construction Core (Green)	CT6G	Add \$112.00 per cylinder
LFIC 6-pin with Temporary Disposable Core	CT6D	No Charge
LFIC 7-pin	C7	Add \$114.00 per cylinder
LFIC 7-pin Less Core	CL7	No Charge
LFIC 7-pin with Temporary Construction Core (Red)	CT7R	Add \$114.00 per cylinder
LFIC 7-pin with Temporary Construction Core (Blue)	CT7B	Add \$114.00 per cylinder
LFIC 7-pin with Temporary Construction Core (Green)	CT7G	Add \$114.00 per cylinder
LFIC 7-pin with temporary Disposable Core	CT7D	No Charge
SFIC		
SFIC 6-pin	C6S	Add \$101.00 per cylinder
SFIC 6-pin with Temporary Construction Core (Blue)	CT6SB	Add \$101.00 per cylinder
SFIC 6-pin or 7-pin with Temporary Disposable Core	CTSD	No Charge
SFIC 7-pin	C7S	Add \$101.00 per cylinder
SFIC 7-pin with Temporary Construction Core (Blue)	CT7SB	Add \$101.00 per cylinder
Security		
Security	HS	Add \$167.00 per cylinder
Security LFIC	CHS	Add \$279.00 per cylinder
Access 3		
Access 3 Patented	AP	No Charge
Access 3 Security	AS	Add \$84.00 per cylinder
Access 3 High Security, UL 437	AHS	Add \$120.00 per cylinder
Access 3 LFIC Patented	ACP	Add \$112.00 per cylinder
Access 3 LFIC Security	ACS	Add \$196.00 per cylinder
Access 3 LFIC High Security, UL 437	ACHS	Add \$232.00 per cylinder
Pyramid		
Pyramid Security Fixed Core	PS	Add \$90.00 per cylinder
Pyramid Security LFIC	PCS	Add \$196.00 per cylinder
Pyramid High Security Fixed Core	PHS	Add \$131.00 per cylinder
Pyramid High Security LFIC	PCHS	Add \$241.00 per cylinder
Pyramid LFIC with Temporary Construction Core	CTP	Add \$112.00 per cylinder
Pyramid LFIC with Temporary Disposable Core	CTPD	No Charge
Pyramid LFIC Less Core	CLP	No Charge
Other		
Master Ring	MR	\$68.00

Continued on next page

Cylinder Options (continued) & Keying Options*				
Description	Specify Quick Code		Add or Deduct	
Keying and Keys				
0-bitted with 2 Blank Keys	(standard)		No Charge	
Keyed Random	KR			
Construction master keyed ^{1, 2}	CMK		Add \$16.00 per cylinder	
More than 2 Keys	KY# (e.g., KY6)		See page 33 - Cut Keys Section	
Master Keying				
Master keyed (all cylinders except CR8000, CR8020, CR8027, CR8200, CR8500, CR8600, CR8700)	MK		Add \$16.00 per cylinder	
Master keyed Pyramid (except CR8020, CR8027)	MK			
Master keyed Security (including LFIC cylinder and core)	MK			
Master keyed Access 3 (except CR8500, CR8600, CR8700 LFIC cores)	MK			
Master keyed (CR8000, CR8020, CR8027, CR8200, CR8500, CR8600, CR8700)	MK-IC		No Charge	
Master keyed to customer bittings or sample key	MK-CB		Add \$16.00 per cylinder	
Visual Cylinder/Key Control (VKC)	Cylinders		Keys	
	Stamping	List Price	Stamping	List Price
VKC0 – No stamping except keyway designation (keys will be tagged)	No Stamping	No Charge	No Stamping	\$5/Cyl
VKC1 – Keys only	N/A	N/A	Keyset	No Charge
VKC2 – Cylinder and keys*	Keyset	\$4/Cyl	Keyset	No Charge
VKC3 – Cylinder*	Keyset	\$4/Cyl	Bittings	No Charge
All VKC, VDC, or VAC stamping codes that use an alternate symbol	Alternate Stamping	\$4/Cyl	Alternate Stamping	\$4/Cyl
Concealed Cylinder/Visual Key Control (CKC)	Cylinders		Keys	
	Stamping	List Price	Stamping	List Price
CKC2 – Cylinder and Keys*	Keyset	\$4/Cyl	Keyset	No Charge
CKC3 – Cylinders only*	Keyset	\$4/Cyl	Bittings	No Charge
All CKC, CDC, or CAC stamping codes that use an alternate symbol	Alternate Stamping	\$4/Cyl	Alternate Stamping	\$4/Cyl

*Cylinder face stamping not available for Access 3, Pyramid, or Security products

Notes:

1. CMK Construction master keying charge is in addition to master keying charge.
2. CMK Construction master keying is not available in interchangeable core, Access 3, Pyramid, or Security series.

*Double cylinder keying: unless otherwise specified, both cylinders of 32, 62, 72 and 82 functions will be keyed alike. The inside cylinder of 52 function will be keyed to the master key(s) only, while the outside cylinder will include the change key. If different keying is required, specify outside cylinder first, then inside cylinder. For key bows other than 10 and 90, specify 'KB' + bow number as Quick Code, e.g. KB12.

Strike Options*

To purchase strike separately, see catalog for part no.

Lip Length	ANSI Curved Lip Specify Quick Code	T-Strike Curved Lip Box Specify Quick Code	Add or Deduct
1-1/4"	SA114 Standard	NA	No Charge
1-3/4"	N/A	SC134	Add \$17.00 per lock
2"	N/A	SC200	
2-1/8"	N/A	SC218	
2-1/4"	N/A	SC214	
2-1/2"	N/A	SC212	
2-3/4"	N/A	SC234	
3"	N/A	SC300	

Lip Length	ANSI Straight Lip For Door Pair** Quick Code	For Door Pair** Quick Code	Add or Deduct
1-13/16"	SA136	SP136	No Charge

Lip length	ANSI Straight Lip For Extended Lip Escutcheon Quick Code	For Extended Lip Escutcheon Quick Code	Add or Deduct
15/16"	Standard when Extended Lip Option is Specified	SX156	No Charge

*If door thickness is standard or has been specified and no special door or frame condition exist, then only the first two characters of the optional strike Quick code must be specified (e.g. "SC").

The correct lip length will be determined by our order entry system based on the standard or specified door thickness.

** Lip is measured from back of strike.

Miscellaneous Options

Description	Specify Quick Code	Add or Deduct
Split designs and split finishes	Outside Trim x Inside Trim	Higher set price prevails
Spanner head screws	M02	Add \$30.00 per lockset
Torx® head screws (on strike)	M04	Add \$36.00 per lockset
Lever to accept 6 or 7-pin SFIC (ESE only)	M08	Deduct \$20.00 per lockset
Extended lip escutcheon (for single door reverse bevel; 630 finish to match 626 only)	M11	Add \$74.00 per lockset
Knurling outside and inside	M20*	Add \$212.00 per lockset
Knurling outside only	M21*	Add \$106.00 per lockset
Knurling Inside only	M22*	
Abrasive coat outside and inside	M23	Add \$134.00 per lockset
Abrasive coat inside only	M24	Add \$67.00 per lockset
Abrasive coat outside only	M25	
Lead lining escutcheon	M28	Add \$141.00 per Escutcheon
Unstaked lever retainer	M33	No Charge

*All levers provided in a powder coat finish will be supplied with an abrasive coating.

Standard Features

Case

Extruded Brass

Shackle

11/32" (8.7mm) diameter hardened steel (PL5000 Series), brass (PL5100 Series) or stainless steel (PL5200 Series)

Locking

Ball-bearing locking heel and toe

Cylinder

RFC model: 6-pin Fixed Core (2300)
IC model: 6-pin & Pyramid IC (8000 series)
L4 keyway standard

Case Quantity

36

Case Weight

27 lbs



Ordering Example

Stock Order

Quantity	Series/Function
10	PL5000R

Access 3 Order

Quantity	Series/Function	Misc. Options
8	PL5070	ACP M44

Contract Order

Quantity	Keypad	Series/Function	Shackle Length	Misc. Options
10	AA1	PL5080	258	M45

Padlocks

Hardened Steel Shackle	Brass Shackle	Description	List Price
PL5000R	PL5100R	Rekeyable Fixed Core (RFC)	\$156.00
PL5070*	PL5170*	Interchangeable core (IC), less core	\$162.00
PL5080	PL5180	IC 6-pin	\$274.00
PL5090	PL5190	IC security	\$441.00
PL5030	PL5130	Pyramid High Security (IC)	\$403.00
PL5037	PL5137	Pyramid Security (IC)	\$358.00

Stainless Steel Shackle	Description	List Price
PL5200R	Rekeyable Fixed Core (RFC)	\$161.00
PL5270*	Interchangeable core (IC), less core	\$167.00
PL5280	IC 6-pin	\$279.00
PL5290	IC security	\$446.00
PL5230	Pyramid High Security (IC)	\$408.00
PL5237	Pyramid Security (IC)	\$363.00

Shackle Length Options with Padlocks

Description	Specify Quick Code	Add or Deduct
7/8"	(standard)	No Charge
2-5/8"	258	Add \$6.00 to padlock

* Access 3 is only available with Less Core.

Cylinder Options & Keying Options**

Description	Specify Quick Code		Add or Deduct	
Keying and Keys				
0-bitted with 2 Blank Keys	(standard)		No Charge	
Keyed Random	KR			
Construction Master Keyed ²	CMK		Add \$16.00 per cylinder	
More than 2 Keys	KY# (e.g., KY6)		See page 33 - Cut Keys Section	
Master Keying				
Master keyed (all cylinders except CR8000, CR8020, CR8027, CR8200, CR8500, CR8600, CR8700)	MK		Add \$16.00 per cylinder	
Master keyed Pyramid (except CR8020, CR8027 LFIC cores)	MK			
Master keyed Security (including LFIC cylinder and core)	MK			
Master keyed Access 3 (except CR8500, CR8600, CR8700 LFIC cores)	MK			
Master keyed (CR8000, CR8020, CR8027, CR8200, CR8500, CR8600, CR8700)	MK-IC		No Charge	
Master keyed to customer bittings or sample key	MK-CB		Add \$16.00 per cylinder	
Visual Cylinder/Key Control (VKC)	Cylinders		Keys	
	Stamping	List Price	Stamping	List Price
VKC0 – No stamping except keyway designation (keys will be tagged)	No Stamping	No Charge	No Stamping	\$5/Cyl
VKC1 – Keys only	N/A	N/A	Keyset	No Charge
VKC2 – Cylinder and keys*	Keyset	\$4/Cyl	Keyset	No Charge
VKC3 – Cylinder*	Keyset	\$4/Cyl	Bittings	No Charge
All VKC, VDC, or VAC stamping codes that use an alternate symbol	Alternate Stamping	\$4/Cyl	Alternate Stamping	\$4/Cyl
Concealed Cylinder/Visual Key Control (CKC)	Cylinders		Keys	
	Stamping	List Price	Stamping	List Price
CKC2 – Cylinder and Keys*	Keyset	\$4/Cyl	Keyset	No Charge
CKC3 – Cylinders only*	Keyset	\$4/Cyl	Bittings	No Charge
All CKC, CDC, or CAC stamping codes that use an alternate symbol	Alternate Stamping	\$4/Cyl	Alternate Stamping	\$4/Cyl

*Cylinder face stamping not available for Access 3, Pyramid, or Security products

Notes: 1. CMK Construction master keying charge is in addition to master keying charge.
 2. CMK construction master keying is not available in interchangeable core, Access 3, Pyramid, or Security series.
 **For key bows other than 10 and 90, specify 'KB' + bow number as Quick Code, e.g. KB12. No extra charge.

Miscellaneous Options

Description	Specify Quick Code	Add or Deduct
Chain and clevis attached	M44	Add \$5.00 to padlock
Custom die stamped case* (specify existing die number or lettering specifications for artwork)	M45	Add \$60 to padlock

*To create new die stamp, contact factory. Provide artwork with request for quotation.
 Die stamps remain the property of Corbin Russwin.

**ANSI/BHMA A156.36
Grade 2**

Standard Features

Handing

Non-handed

Door Thickness

1-3/8" - 2-1/4"

Backset

2-3/4" (standard)
2-3/8" available

Strike

2-3/4" x 1-1/8"

Cylinder

Brass 6-pin,
0-bitted, L4 keyway

Keys

Two nickel silver keys

Case Quantity

12

Case Weight

24 lbs

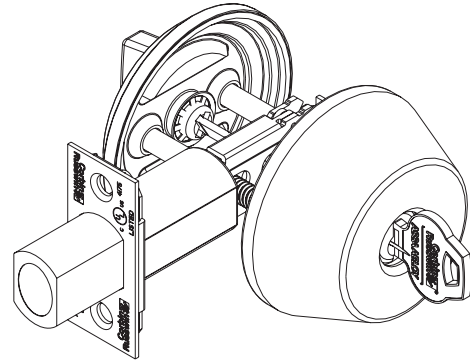

Ordering Example

Stock Order

Quantity	Series/Function	Finish
30	DL2213	626

Contract Order

Quantity	Series/Function	Finish	Keyset	Optional Strike
30	DL2213	626	AA1	SS134

Function	Description	Finish: 613E, 626, BSP, WSP	Finish: 605, 606, 612, 613, 625
DL2213	Single Cylinder	\$164.00	\$171.00
DL2212	Double Cylinder	\$211.00	\$218.00
DL2217	Classroom	\$164.00	\$171.00
DL2211	Cylinder x Blank		
DL2260	Thumbturn x Blank	\$119.00	\$123.00
DL2261	Thumbturn x Indicator*	\$132.00	\$136.00

Notes:

Both cylinders of double cylinder deadlocks are keyed alike, unless otherwise specified. If different keying is required, specify outside cylinder first, then inside cylinder.

*Indicator option code MUST be specified when ordering DL2261. If none specified, V21 will be provided as default.

Cylinder Options		
Description	Specify Quick Code	Add or Deduct
Conventional 6-pin	(standard)	No Charge
Conventional 7-pin	7P	Add \$2.00 per cylinder
Less Standard Cylinder	LC	No Deduct
LFIC		
LFIC 6-pin	C6	Add \$112.00 per cylinder
LFIC 6-pin Less Core	CL6	No Charge
LFIC 6-pin with Temporary Construction Core (Red)	CT6R	Add \$112.00 per cylinder
LFIC 6-pin with Temporary Construction Core (Blue)	CT6B	Add \$112.00 per cylinder
LFIC 6-pin with Temporary Construction Core (Green)	CT6G	Add \$112.00 per cylinder
LFIC 6-pin with Temporary Disposable Core	CT6D	No Charge
LFIC 7-pin	C7	Add \$114.00 per cylinder
LFIC 7-pin Less Core	CL7	No Charge
LFIC 7-pin with Temporary Construction Core (Red)	CT7R	Add \$114.00 per cylinder
LFIC 7-pin with Temporary Construction Core (Blue)	CT7B	Add \$114.00 per cylinder
LFIC 7-pin with Temporary Construction Core (Green)	CT7G	Add \$114.00 per cylinder
LFIC 7-pin with temporary Disposable Core	CT7D	No Charge
SFIC		
SFIC 6-pin	C6S	Add \$101.00 per cylinder
SFIC 6-pin with Temporary Construction Core (Blue)	CT6SB	Add \$101.00 per cylinder
SFIC 6-pin or 7-pin with Temporary Disposable Core	CTSD	No Charge
SFIC 7-pin	C7S	Add \$101.00 per cylinder
SFIC 7-pin with Temporary Construction Core (Blue)	CT7SB	Add \$101.00 per cylinder
Security		
Security	HS	Add \$167.00 per cylinder
Security LFIC	CHS	Add \$279.00 per cylinder
Access 3		
Access 3 Patented	AP	No Charge
Access 3 Security	AS	Add \$84.00 per cylinder
Access 3 High Security, UL 437	AHS	Add \$120.00 per cylinder
Access 3 LFIC Patented	ACP	Add \$112.00 per cylinder
Access 3 LFIC Security	ACS	Add \$196.00 per cylinder
Access 3 LFIC High Security, UL 437	ACHS	Add \$232.00 per cylinder
Pyramid		
Pyramid Security Fixed Core	PS	Add \$90.00 per cylinder
Pyramid Security LFIC	PCS	Add \$196.00 per cylinder
Pyramid High Security Fixed Core	PHS	Add \$131.00 per cylinder
Pyramid High Security LFIC	PCHS	Add \$241.00 per cylinder
Pyramid LFIC with Temporary Construction Core	CTP	Add \$112.00 per cylinder
Pyramid LFIC with Temporary Disposable Core	CTPD	No Charge
Pyramid LFIC Less Core	CLP	No Charge
Keying and Keys		
0-bitted with 2 Blank Keys	(standard)	No Charge
Keyed Random	KR	
Construction master keyed ^{1,2}	CMK	Add \$16.00 per cylinder
More than 2 Keys	KY# (e.g., KY6)	See page 33 - Cut Keys Section
Master Keying		
Master keyed (all cylinders except CR8000, CR8020, CR8027, CR8200, CR8500, CR8600, CR8700)	MK	Add \$16.00 per cylinder
Master keyed Pyramid (except CR8020, CR8027 LFIC cores)	MK	
Master keyed Security (including LFIC cylinder and core)	MK	
Master keyed Access 3 (except CR8500, CR8600, CR8700 LFIC cores)	MK	
Master keyed (CR8000, CR8020, CR8027, CR8200, CR8500, CR8600, CR8700)	MK-IC	No Charge
Master keyed to customer bittings or sample key	MK-CB	Add \$16.00 per cylinder

Cylinder Options (continued) & Keying Options**

Visual Cylinder/Key Control (VKC)	Cylinders		Keys	
	Stamping	List Price	Stamping	List Price
VKC0 – No stamping except keyway designation (keys will be tagged)	No Stamping	No Charge	No Stamping	\$5/Cyl
VKC1 – Keys only	N/A	N/A	Keyset	No Charge
VKC2 – Cylinder and keys*	Keyset	\$4/Cyl	Keyset	No Charge
VKC3 – Cylinder*	Keyset	\$4/Cyl	Bittings	No Charge
All VKC, VDC, or VAC stamping codes that use an alternate symbol	Alternate Stamping	\$4/Cyl	Alternate Stamping	\$4/Cyl
Concealed Cylinder/Visual Key Control (CKC)	Cylinders		Keys	
	Stamping	List Price	Stamping	List Price
CKC2 – Cylinder and Keys*	Keyset	\$4/Cyl	Keyset	No Charge
CKC3 – Cylinders only*	Keyset	\$4/Cyl	Bittings	No Charge
All CKC, CDC, or CAC stamping codes that use an alternate symbol	Alternate Stamping	\$4/Cyl	Alternate Stamping	\$4/Cyl

*Cylinder face stamping not available for Access 3, Pyramid, or Security products

- Notes: 1. CMK Construction master keying charge is in addition to master keying charge.
 2. CMK Construction master keying is not available in interchangeable core, Access 3, Pyramid, or Security series.

** For key bows other than 10 and 90, specify 'KB' + bow number as Quick Code, e.g. KB12.

Strike Options

To purchase strike separately, see catalog or parts manual for part no.

Lip Length	ANSI Straight Lip - Specify Quick Code	Add or Deduct
7/8"	SS078	No Charge
1-1/8"	SS118	
1-1/4"	SS114	
1-3/8"	SS138	
1-1/2"	SS112	
1-3/4"	SS134	Add \$17.00 per lock
2"	SS200	
2-1/4"	SS214	
2-1/2"	SS212	
2-3/4"	SS234	
3"	SS300	

Door Thickness Options

Description	Specify Quick Code	Add or Deduct
1-3/8"	D138	No Charge
1-3/4"	(standard)	No Charge
2"	D200	No Charge
2-1/4"	D214	No Charge

Indicator Options

Description	Specify Quick Code	Add or Deduct
Indicator inside only "Unlocked/Locked" in green/red	V01	Add \$34.00 per lock
Indicator inside only "Unlocked/Locked" in white/red	V04	
Indicator inside only, French "Ouvvert/Fermé" in green/red	V01F	
Indicator both sides "Unlocked/Locked" x "Vacant/Occupied" in green/red (Std for DL2261)	V21	No Charge
Indicator both sides "Unlocked/Locked" x "Vacant/Occupied" in white/red	V54	
Indicator both sides, French "Ouvvert/Fermé" x "Libre/Occupée" in green/red	V21F	

Miscellaneous Options

Description	Specify Quick Code	Add or Deduct
1" (25mm) bolt front, square corners	M14	Add \$7.00 per lockset
ANSI wrought strike box	M17	No Charge
Plastic box for standard strike	(standard)	No Charge
2-3/8" (60mm) backset bolt	B238	No Charge

Standard Features
Handing

Non-handed, except DL3017 function

Door Thickness

1-3/4" - 2-1/4"

Backset

2-3/4" (standard)

Strike

Wrought brass or bronze
2-3/4" x 1-1/8" with
wrought box

Cylinder

Brass 6-pin,
0-bitted, L4 keyway

Keys

Two nickel silver keys

Weight

2.5 lbs each

Case Quantity

12

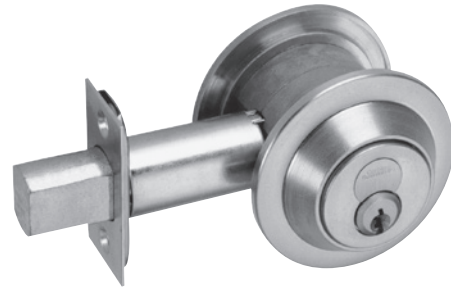

Ordering Example

Stock Order

Quantity	Series/Function	Finish
30	DL3013	626

Contract Order

Quantity	Series/Function	Finish	Keypad	Optional Strike
30	DL3013	626	AA1	SD001

Function	Description	Finish: 605, 606, 612 613 613E, 618, 619, 625, 626, 722, BSP, WSP
DL3013	Single Cylinder	\$382.00
DL3012	Double Cylinder	\$512.00
DL3017	Classroom*	\$390.00
DL3011	Cylinder x Blank	\$382.00
DL3060	Thumbturn x Blank	

*Thumbturn will not project deadbolt. Specify hand.

Cylinder Options		
Description	Specify Quick Code	Add or Deduct
Conventional 6-pin	(standard)	No Charge
Conventional 7-pin	7P	Add \$2.00 per cylinder
Less Standard Cylinder	LC	Deduct \$130.00 per cylinder
LFIC		
LFIC 6-pin	C6	Add \$112.00 per cylinder
LFIC 6-pin Less Core	CL6	No Charge
LFIC 6-pin with Temporary Construction Core (Red)	CT6R	Add \$112.00 per cylinder
LFIC 6-pin with Temporary Construction Core (Blue)	CT6B	Add \$112.00 per cylinder
LFIC 6-pin with Temporary Construction Core (Green)	CT6G	Add \$112.00 per cylinder
LFIC 6-pin with Temporary Disposable Core	CT6D	No Charge
LFIC 7-pin	C7	Add \$114.00 per cylinder
LFIC 7-pin Less Core	CL7	Add \$2.00 per cylinder
LFIC 7-pin with Temporary Construction Core (Red)	CT7R	Add \$114.00 per cylinder
LFIC 7-pin with Temporary Construction Core (Blue)	CT7B	Add \$114.00 per cylinder
LFIC 7-pin with Temporary Construction Core (Green)	CT7G	Add \$114.00 per cylinder
LFIC 7-pin with temporary Disposable Core	CT7D	Add \$2.00 per cylinder
UL LFIC 6-Pin Housing Less Core	CL6AH	Add \$112.00 per cylinder
UL LFIC 6-Pin Housing with Disposable Core	CTAHD	Add \$112.00 per cylinder
UL LFIC 6-Pin Housing with Temp Construction Core	CT6AH(R/B/G)	Add \$242.00 per cylinder
SFIC		
SFIC 6-pin	C6S	Add \$101.00 per cylinder
SFIC 6-pin with Temporary Construction Core (Blue)	CT6SB	Add \$101.00 per cylinder
SFIC 6-pin with SFIC Disposable Temporary Core	CT6SD	No Charge
SFIC 6-pin Less Core	CLS6	No Charge
SFIC 7-pin	C7S	Add \$101.00 per cylinder
SFIC 7-pin with Temporary Construction Core (Blue)	CT7SB	Add \$101.00 per cylinder
SFIC 7-pin with SFIC Disposable Temporary Core	CT7SD	No Charge
SFIC 7-pin Less Core	CLS7	No Charge
Security		
Security	HS	Add \$171.00 per cylinder
Security LFIC	CHS	Add \$279.00 per cylinder
Access 3		
Access 3 Patented	AP	No Charge
Access 3 Security	AS	Add \$84.00 per cylinder
Access 3 High Security, UL 437	AHS	Add \$120.00 per cylinder
Access 3 LFIC Patented	ACP	Add \$112.00 per cylinder
Access 3 LFIC Security	ACS	Add \$196.00 per cylinder
Access 3 LFIC High Security, UL 437	ACHS	Add \$232.00 per cylinder
Pyramid		
Pyramid Security Fixed Core	PS	Add \$90.00 per cylinder
Pyramid Security LFIC	PCS	Add \$196.00 per cylinder
Pyramid High Security Fixed Core	PHS	Add \$135.00 per cylinder
Pyramid High Security LFIC	PCHS	Add \$241.00 per cylinder
Pyramid LFIC with Temporary Construction Core	CTP	Add \$112.00 per cylinder
Pyramid LFIC with Temporary Disposable Core	CTPD	No Charge
Pyramid LFIC Less Core	CLP	No Charge

Notes:

1. CMK Construction master keying charge is in addition to master keying charge.

*Both cylinders of double cylinder deadlocks are keyed alike, unless otherwise specified. If different keying is required, specify outside cylinder first, then inside cylinder.

For key bows other than 10 and 90, specify 'KB' + bow number as Quick Code, e.g. KB12.

Note: KB92 cannot be furnished with VKC or other markings.

Cylinder Options (continued) & Keying Options**

Description	Specify Quick Code	Add or Deduct		
Keying and Keys				
0-bitted with 2 Blank Keys	(standard)	No Charge		
Keyed Random	KR			
Construction master keyed ^{1,2}	CMK	Add \$16.00 per cylinder		
More than 2 Keys	KY# (e.g., KY6)	See page 33 - Cut Keys Section		
Master Keying				
Master keyed (all cylinders except CR8000, CR8020, CR8027, CR8200, CR8500, CR8600, CR8700)	MK	Add \$16.00 per cylinder		
Master keyed Pyramid (except CR8020, CR8027 LFIC cores)	MK			
Master keyed Security (including LFIC cylinder and core)	MK			
Master keyed Access 3 (except CR8500, CR8600, CR8700 LFIC cores)	MK			
Master keyed (CR8000, CR8020, CR8027, CR8200, CR8500, CR8600, CR8700)	MK-IC	No Charge		
Master keyed to customer bittings or sample key	MK-CB	Add \$16.00 per cylinder		
Visual Cylinder/Key Control (VKC)	Cylinders		Keys	
	Stamping	List Price	Stamping	List Price
VKC0 – No stamping except keyway designation (keys will be tagged)	No Stamping	No Charge	No Stamping	\$5/Cyl
VKC1 – Keys only	N/A	N/A	Keyset	No Charge
VKC2 – Cylinder and keys*	Keyset	\$4/Cyl	Keyset	No Charge
VKC3 – Cylinder*	Keyset	\$4/Cyl	Bittings	No Charge
All VKC, VDC, or VAC stamping codes that use an alternate symbol	Alternate Stamping	\$4/Cyl	Alternate Stamping	\$4/Cyl
Concealed Cylinder/Visual Key Control (CKC)	Cylinders		Keys	
	Stamping	List Price	Stamping	List Price
CKC2 – Cylinder and Keys*	Keyset	\$4/Cyl	Keyset	No Charge
CKC3 – Cylinders only*	Keyset	\$4/Cyl	Bittings	No Charge
All CKC, CDC, or CAC stamping codes that use an alternate symbol	Alternate Stamping	\$4/Cyl	Alternate Stamping	\$4/Cyl

*Cylinder face stamping not available for Access 3, Pyramid, or Security products

Notes: 1. CMK Construction master keying charge is in addition to master keying charge.
2. CMK Construction master keying is not available in interchangeable core, Access 3, Pyramid, or Security series.

** For key bows other than 10 and 90, specify 'KB' + bow number as Quick Code, e.g. KB12.

Strike Options*

To purchase strike separately, see catalog or parts manual for part no.

Lip Length	ANSI Straight Lip - Specify Quick Code	Add or Deduct
7/8"	SS078	No Charge
1-1/8"	SS118	
1-1/4"	SS114	
1-3/8"	SS138	
1-1/2"	SS112	
1-3/4"	SS134	
2"	SS200	Add \$17.00 per lock
2-1/4"	SS214	
2-1/2"	SS212	
2-3/4"	SS234	
3"	SS300	

Strike Options (No lip)

Description	Specify Quick Code	Add or Deduct
2-3/4" x 1-1/8"	(standard)	No Charge
3-1/2" x 1-1/8"	SD001	

Door Thickness Options

Description	Specify Quick Code	Add or Deduct
1-3/8" (Not available in IC option)	D138	No Charge
1-3/4" - 2"	(standard)	
2-1/4"	D214	Add \$7.00 per lockset

Miscellaneous Options

Description	Specify Quick Code	Add or Deduct
ANSI wrought box	M17	No Charge
Ergonomic Thumbturn	M34	Add \$22.00 per TT
Plastic box for standard strike	PStdStrike	No Charge
2-3/8" backset	B238	

Standard Features

Handing
Non-handed

Door Thickness
1-3/8" - 2-1/4"

Backset
2-3/4" (standard)
2-3/8" available

Strike
2-3/4" x 1-1/8"

Cylinder
Brass 6-pin,
0-bitted, L4 keyway

Keys
Two nickel silver keys

Case Quantity 12
Case Weight 24 lbs

**ANSI/BHMA 156.36
Grade 1**

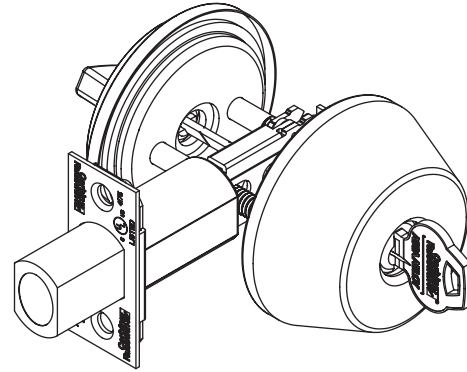

Ordering Example

Stock Order

Quantity	Series/Function	Finish
30	DL3213	626

Contract Order

Quantity	Series/Function	Finish	Keyset	Optional Strike
30	DL3213	626	AA1	SS134

Function	Description	Finish: 613E, 626, BSP, WSP	Finish: 605, 606, 612, 613, 625
DL3213	Single Cylinder	\$298.00	\$305.00
DL3212	Double Cylinder	\$418.00	\$425.00
DL3217	Classroom	\$298.00	\$305.00
DL3211	Cylinder x Blank		
DL3260	Thumbturn x Blank	\$253.00	\$257.00

Cylinder Options		
Description	Specify Quick Code	Add or Deduct
Conventional 6-pin	(standard)	No Charge
Conventional 7-pin	7P	Add \$2.00 per cylinder
Less Standard Cylinder	LC	Deduct \$120.00 per cylinder
LFIC		
LFIC 6-pin	C6	Add \$112.00 per cylinder
LFIC 6-pin Less Core	CL6	No Charge
LFIC 6-pin with Temporary Construction Core (Red)	CT6R	Add \$112.00 per cylinder
LFIC 6-pin with Temporary Construction Core (Blue)	CT6B	Add \$112.00 per cylinder
LFIC 6-pin with Temporary Construction Core (Green)	CT6G	Add \$112.00 per cylinder
LFIC 6-pin with Temporary Disposable Core	CT6D	No Charge
LFIC 7-pin	C7	Add \$114.00 per cylinder
LFIC 7-pin Less Core	CL7	No Charge
LFIC 7-pin with Temporary Construction Core (Red)	CT7R	Add \$114.00 per cylinder
LFIC 7-pin with Temporary Construction Core (Blue)	CT7B	Add \$114.00 per cylinder
LFIC 7-pin with Temporary Construction Core (Green)	CT7G	Add \$114.00 per cylinder
LFIC 7-pin with temporary Disposable Core	CT7D	No Charge
SFIC		
SFIC 6-pin	C6S	Add \$101.00 per cylinder
SFIC 6-pin with Temporary Construction Core (Blue)	CT6SB	Add \$101.00 per cylinder
SFIC 6-pin or 7-pin with Temporary Disposable Core	CTSD	No Charge
SFIC 7-pin	C7S	Add \$101.00 per cylinder
SFIC 7-pin with Temporary Construction Core (Blue)	CT7SB	Add \$101.00 per cylinder
Security		
Security	HS	Add \$167.00 per cylinder
Security LFIC	CHS	Add \$279.00 per cylinder
Access 3		
Access 3 Patented	AP	No Charge
Access 3 Security	AS	Add \$84.00 per cylinder
Access 3 High Security, UL 437	AHS	Add \$120.00 per cylinder
Access 3 LFIC Patented	ACP	Add \$112.00 per cylinder
Access 3 LFIC Security	ACS	Add \$196.00 per cylinder
Access 3 LFIC High Security, UL 437	ACHS	Add \$232.00 per cylinder
Pyramid		
Pyramid Security Fixed Core	PS	Add \$90.00 per cylinder
Pyramid Security LFIC	PCS	Add \$196.00 per cylinder
Pyramid High Security Fixed Core	PHS	Add \$131.00 per cylinder
Pyramid High Security LFIC	PCHS	Add \$241.00 per cylinder
Pyramid LFIC with Temporary Construction Core	CTP	Add \$112.00 per cylinder
Pyramid LFIC with Temporary Disposable Core	CTPD	No Charge
Pyramid LFIC Less Core	CLP	No Charge

Notes:

1. CMK Construction master keying charge is in addition to master keying charge.

*Both cylinders of double cylinder deadlocks are keyed alike, unless otherwise specified. If different keying is required, specify outside cylinder first, then inside cylinder.

For key bows other than 10 and 90, specify 'KB' + bow number as Quick Code, e.g. KB12.

Note: KB92 cannot be furnished with VKC or other markings.

Cylinder Options (continued) & Keying Options**

Description	Specify Quick Code	Add or Deduct		
Keying and Keys				
0-bitted with 2 Blank Keys	(standard)	No Charge		
Keyed Random	KR			
Construction master keyed ^{1,2}	CMK	Add \$16.00 per cylinder		
More than 2 Keys	KY# (e.g., KY6)	See page 33 - Cut Keys Section		
Master Keying				
Master keyed (all cylinders except CR8000, CR8020, CR8027, CR8200, CR8500, CR8600, CR8700)	MK	Add \$16.00 per cylinder		
Master keyed Pyramid (except CR8020, CR8027 LFIC cores)	MK			
Master keyed Security (including LFIC cylinder and core)	MK			
Master keyed Access 3 (except CR8500, CR8600, CR8700 LFIC cores)	MK			
Master keyed (CR8000, CR8020, CR8027, CR8200, CR8500, CR8600, CR8700)	MK-IC	No Charge		
Master keyed to customer bittings or sample key	MK-CB	Add \$16.00 per cylinder		
Visual Cylinder/Key Control (VKC)	Cylinders		Keys	
	Stamping	List Price	Stamping	List Price
VKC0 – No stamping except keyway designation (keys will be tagged)	No Stamping	No Charge	No Stamping	\$5/Cyl
VKC1 – Keys only	N/A	N/A	Keyset	No Charge
VKC2 – Cylinder and keys*	Keyset	\$4/Cyl	Keyset	No Charge
VKC3 – Cylinder*	Keyset	\$4/Cyl	Bittings	No Charge
All VKC, VDC, or VAC stamping codes that use an alternate symbol	Alternate Stamping	\$4/Cyl	Alternate Stamping	\$4/Cyl
Concealed Cylinder/Visual Key Control (CKC)	Cylinders		Keys	
	Stamping	List Price	Stamping	List Price
CKC2 – Cylinder and Keys*	Keyset	\$4/Cyl	Keyset	No Charge
CKC3 – Cylinders only*	Keyset	\$4/Cyl	Bittings	No Charge
All CKC, CDC, or CAC stamping codes that use an alternate symbol	Alternate Stamping	\$4/Cyl	Alternate Stamping	\$4/Cyl

*Cylinder face stamping not available for Access 3, Pyramid, or Security products

- Notes: 1. CMK Construction master keying charge is in addition to master keying charge.
 2. CMK Construction master keying is not available in interchangeable core, Access 3, Pyramid, or Security series.
 ** For key bows other than 10 and 90, specify 'KB' + bow number as Quick Code, e.g. KB12.

Strike Options

To purchase strike separately, see catalog or parts manual for part no.

Lip Length	ANSI Straight Lip - Specify Quick Code	Add or Deduct
7/8"	SS078	No Charge
1-1/8"	SS118	
1-1/4"	SS114	
1-3/8"	SS138	
1-1/2"	SS112	
1-3/4"	SS134	
2"	SS200	Add \$17.00 per lock
2-1/4"	SS214	
2-1/2"	SS212	
2-3/4"	SS234	
3"	SS300	

Door Thickness Options

Description	Specify Quick Code	Add or Deduct
1-3/8"	D138	No Charge
1-3/4"	(standard)	
2"	D200	
2-1/4"	D214	

Miscellaneous Options

Description	Specify Quick Code	Add or Deduct
1" (25mm) bolt front, square corners	M14	Add \$6.00 per dead lock
ANSI wrought strike box	M17	No Charge
Plastic box for standard strike	(standard)	
2-3/8" (60mm) backset bolt	B238	

Standard Features

Handing

Non-handed

Door Thickness

1-3/4"

Backset

2-3/4"

Strike

Wrought brass or bronze
3-1/2" x 1-1/8"

Cylinder

6-pin, L4 keyway, 0-bitted

Keys

Two nickel silver keys

Weight

2.25 lbs each

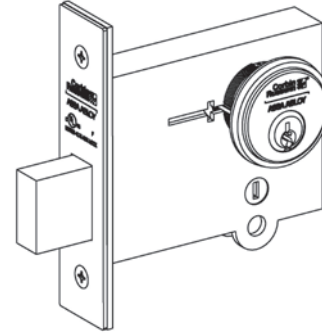

Ordering Example

Stock Order

Quantity	Series/Function	Finish
30	DL4113	626

Contract Order

Quantity	Series/Function	Finish	Keyset	Optional Strike
30	DL4113	626	AA1	SS118

Function	Description	Finish: 613E, 626, BSP	Finish: 605, 606, 611, 612, 613, 618, 619 ,625
DL4113	Single Cylinder	\$523.00	\$528.00
DL4112	Double Cylinder	\$574.00	\$579.00
DL4117	Classroom*	\$523.00	\$528.00
DL4111	Cylinder x Blank	\$440.00	\$445.00
DL4122	Double Cylinder x Thumbturn*	\$656.00	\$661.00
DL4160	Thumbturn x Blank	\$389.00	\$394.00

*Thumbturn will not project deadbolt.

Cylinder Options		
Description	Specify Quick Code	Add or Deduct
Conventional 6-pin	(standard)	No Charge
Conventional 7-pin	7P	Add \$2.00 per cylinder
Less Standard Cylinder	LC	Deduct \$130.00 per cylinder
LFIC		
LFIC 6-pin	C6	Add \$112.00 per cylinder
LFIC 6-pin Less Core	CL6	No Charge
LFIC 6-pin with Temporary Construction Core (Red)	CT6R	Add \$112.00 per cylinder
LFIC 6-pin with Temporary Construction Core (Blue)	CT6B	Add \$112.00 per cylinder
LFIC 6-pin with Temporary Construction Core (Green)	CT6G	Add \$112.00 per cylinder
LFIC 6-pin with Temporary Disposable Core	CT6D	No Charge
LFIC 7-pin	C7	Add \$114.00 per cylinder
LFIC 7-pin Less Core	CL7	Add \$2.00 per cylinder
LFIC 7-pin with Temporary Construction Core (Red)	CT7R	Add \$114.00 per cylinder
LFIC 7-pin with Temporary Construction Core (Blue)	CT7B	Add \$114.00 per cylinder
LFIC 7-pin with Temporary Construction Core (Green)	CT7G	Add \$114.00 per cylinder
LFIC 7-pin with temporary Disposable Core	CT7D	Add \$2.00 per cylinder
UL LFIC 6-Pin Housing Less Core	CL6AH	Add \$112.00 per cylinder
UL LFIC 6-Pin Housing with Disposable Core	CTAHD	Add \$112.00 per cylinder
UL LFIC 6-Pin Housing with Temp Construction Core	CT6AH(R/B/G)	Add \$242.00 per cylinder
SFIC		
SFIC 6-pin	C6S	Add \$101.00 per cylinder
SFIC 6-pin with Temporary Construction Core (Blue)	CT6SB	Add \$101.00 per cylinder
SFIC 6-pin with SFIC Disposable Temporary Core	CT6SD	No Charge
SFIC 6-pin with Less Core	CLS6	No Charge
SFIC 7-pin	C7S	Add \$101.00 per cylinder
SFIC 7-pin with Temporary Construction Core (Blue)	CT7SB	Add \$101.00 per cylinder
SFIC 7-pin with SFIC Disposable Temporary Core	CT7SD	No Charge
SFIC 7-pin with Less Core	CLS7	No Charge
Security		
Security	HS	Add \$171.00 per cylinder
Security LFIC	CHS	Add \$279.00 per cylinder
Access 3		
Access 3 Patented	AP	No Charge
Access 3 Security	AS	Add \$84.00 per cylinder
Access 3 High Security, UL 437	AHS	Add \$120.00 per cylinder
Access 3 LFIC Patented	ACP	Add \$112.00 per cylinder
Access 3 LFIC Security	ACS	Add \$196.00 per cylinder
Access 3 LFIC High Security, UL 437	ACHS	Add \$232.00 per cylinder
Pyramid		
Pyramid Security Fixed Core	PS	Add \$90.00 per cylinder
Pyramid Security LFIC	PCS	Add \$196.00 per cylinder
Pyramid High Security Fixed Core	PHS	Add \$135.00 per cylinder
Pyramid High Security LFIC	PCHS	Add \$241.00 per cylinder
Pyramid LFIC with Temporary Construction Core	CTP	Add \$112.00 per cylinder
Pyramid LFIC with Temporary Disposable Core	CTPD	No Charge
Pyramid LFIC Less Core	CLP	No Charge

Notes:

1. CMK Construction master keying charge is in addition to master keying charge.

*Both cylinders of double cylinder deadlocks are keyed alike, unless otherwise specified. If different keying is required, specify outside cylinder first, then inside cylinder.

For key bows other than 10 and 90, specify 'KB' + bow number as Quick Code, e.g. KB12.

Note: KB92 cannot be furnished with VKC or other markings.

Cylinder Options (continued) & Keying Options**				
Description	Specify Quick Code		Add or Deduct	
Keying and Keys				
0-bitted with 2 Blank Keys	(standard)		No Charge	
Keyed Random	KR			
Construction master keyed ^{1,2}	CMK		Add \$16.00 per cylinder	
More than 2 Keys	KY# (e.g., KY6)		See page 33 - Cut Keys Section	
Master Keying				
Master keyed (all cylinders except CR8000, CR8020, CR8027, CR8200, CR8500, CR8600, CR8700)	MK		Add \$16.00 per cylinder	
Master keyed Pyramid (except CR8020, CR8027 LFIC cores)	MK			
Master keyed Security (including LFIC cylinder and core)	MK			
Master keyed Access 3 (except CR8500, CR8600, CR8700 LFIC cores)	MK			
Master keyed (CR8000, CR8020, CR8027, CR8200, CR8500, CR8600, CR8700)	MK-IC		No Charge	
Master keyed to customer bittings or sample key	MK-CB		Add \$16.00 per cylinder	
Visual Cylinder/Key Control (VKC)	Cylinders		Keys	
	Stamping	List Price	Stamping	List Price
VKC0 – No stamping except keyway designation (keys will be tagged)	No Stamping	No Charge	No Stamping	\$5/Cyl
VKC1 – Keys only	N/A	N/A	Keyset	No Charge
VKC2 – Cylinder and keys*	Keyset	\$4/Cyl	Keyset	No Charge
VKC3 – Cylinder*	Keyset	\$4/Cyl	Bittings	No Charge
All VKC, VDC, or VAC stamping codes that use an alternate symbol	Alternate Stamping	\$4/Cyl	Alternate Stamping	\$4/Cyl
Concealed Cylinder/Visual Key Control (CKC)	Cylinders		Keys	
	Stamping	List Price	Stamping	List Price
CKC2 – Cylinder and Keys*	Keyset	\$4/Cyl	Keyset	No Charge
CKC3 – Cylinders only*	Keyset	\$4/Cyl	Bittings	No Charge
All CKC, CDC, or CAC stamping codes that use an alternate symbol	Alternate Stamping	\$4/Cyl	Alternate Stamping	\$4/Cyl

*Cylinder face stamping not available for Access 3, Pyramid, or Security products

Notes: 1. CMK Construction master keying charge is in addition to master keying charge.
2. CMK Construction master keying is not available in interchangeable core, Access 3, Pyramid, or Security series.

** For key bows other than 10 and 90, specify 'KB' + bow number as Quick Code, e.g. KB12.

Strike Options

To purchase strike separately, see catalog for part no.

Lip length	ANSI Straight Lip Specify Quick Code	Add or Deduct
7/8"	SS078	Add \$17.00 per lock
1-1/8"	SS118	
1-1/4"	SS114	
1-3/8"	SS138	
1-1/2"	SS112	
1-3/4"	SS134	
2"	SS200	
2-1/4"	SS214	
2-1/2"	SS212	
2-3/4"	SS234	
3"	SS300	

Door Thickness Options

Description	Specify Quick Code	Add or Deduct
1-3/4" - 2"	(standard)	No Charge
2-1/4"	D214	

Miscellaneous Options

Description	Specify Quick Code	Add or Deduct
Spanner head screws	M02	Add \$30.00 per lockset
Torx head screws	M04	Add \$36.00 per lockset
ANSI wrought box	M17	No Charge
Lead wrapped case	M29	Add \$404.00 per lockset
Ergonomic Thumbturn (specify door thickness)	M34	Add \$22.00 per TT
Box for standard strike	M40	No Charge

Table of Contents

Multi-Point Exit Device Latching System

USA & Canada Prices Effective March 3, 2025

FE5400S Series Multi-Point Exit Device Latching System:

FE5400S Series Standard Features, Ordering Examples, Pricing	183
FE5400S Series Heavy-Duty Trim Designs: A9 Armstrong, C9 Citation, D9 Dirke, E9 Essex	184
FE5400S Series Heavy-Duty Trim Designs: L9 Lustra, N9 Newport, R9 Regis, PR9 Princeton	185
FE5400S Series Heavy-Duty Trim Designs: TH900 Pull/Thumbpiece, P9 Pull	186
FE5400S Series Heavy-Duty Trim Designs: FR9 Frascati, M9 Merlot, Z9 Zinfandel	187
FE5400S Series Heavy-Duty Trim Designs: Muséo® Georgia, Jackson, Laszlo, Marc, Salvador, Piet	188
FE5400S Series Electrically Controlled Trim Designs: A9 Armstrong, C9 Citation, D9 Dirke, E9 Essex	189
FE5400S Series Electrically Controlled Trim Designs: L9 Lustra, N9 Newport, R9 Regis, PR9 Princeton	190
FE5400S Series Electrically Controlled Trim Designs: FR9 Frascati, M9 Merlot, Z9 Zinfandel	191
FE5400S Series Electrically Controlled Trim Designs: Muséo® Georgia, Jackson, Laszlo, Marc, Salvador, Piet	192
FE5400S Series Electrified Options & Accessories	193
FE5400S Series Cylinder & Keying Options	194
FE5400S Series Cylinder & Keying Options (Con't), Door Height, Door Width, Door Thickness, Miscellaneous Options	195
FE5400S Series Removable Mullions & Options	196

MP6600 Series Multi-Point Latching System:

MP6600 Series Standard Features	197
MP6600 Series: Single Cylinder, Double Cylinder with Deadbolt, Non-Keyed, EAC: ASA, CSA, LSA, NSA, PSA, RSA, NSM, NSN, NSR Levers	198
MP6600 Series Designs: Escutcheons with Single, Double Cylinder with Deadbolt, Non-Keyed, EAC, Georgia, Jackson, Josef, Laszlo, Marc, Salvador Levers	199
MP6600 Series Designs: Roses with Single, Double Cylinder with Deadbolt, Non-Keyed, EAC, Georgia, Jackson, Josef, Laszlo, Marc, Salvador Levers	200
MP6600 Series Designs: Escutcheons with Single, Double Cylinder with Deadbolt, Non-Keyed, EAC, Josef, Georges Levers	201
MP6600 Series Designs: Roses with Single, Double Cylinder with Deadbolt, Non-Keyed, EAC, Josef, Georges Levers	202
MP6600 Series Designs: Escutcheons with Single, Double Cylinder with Deadbolt, Non-Keyed, EAC, Piet Levers	203
MP6600 Series Designs: Roses with Single, Double Cylinder with Deadbolt, Non-Keyed, EAC, Piet Levers	204
MP6600 Series Designs: Escutcheons with Single, Double Cylinder with Deadbolt, Non-Keyed, EAC, Piet Levers	205
MP6600 Series Designs: Roses with Single, Double Cylinder with Deadbolt, Non-Keyed, EAC, Piet Levers	206
MP6600 Series Cylinder & Keying Options	207
MP6600 Series Cylinder & Keying Options (Con't), Strike Options	208
MP6600 Series Door Thickness, Options, Thumbturn Options, Strike Options	209

FE6600 Series Multi-Point Latching System:

FE6600 Series Standard Features	210
FE6600 Series: Single Cylinder, Double Cylinder with Deadbolt, Non-Keyed, EAC: ASA, CSA, LSA, NSA, PSA, RSA, NSM, NSN, NSR Levers	211
FE6600 Series Designs: Escutcheons with Single, Double Cylinder with Deadbolt, Non-Keyed, EAC, Georgia, Jackson, Josef, Laszlo, Marc, Salvador Levers	212
FE6600 Series Designs: Roses with Single, Double Cylinder with Deadbolt, Non-Keyed, EAC, Georgia, Jackson, Josef, Laszlo, Marc, Salvador Levers	213
FE6600 Series Designs: Escutcheons with Single, Double Cylinder with Deadbolt, Non-Keyed, EAC, Josef, Georges Levers	214
FE6600 Series Designs: Roses with Single, Double Cylinder with Deadbolt, Non-Keyed, EAC, Josef, Georges Levers	215
FE6600 Series Designs: Escutcheons with Single, Double Cylinder with Deadbolt, Non-Keyed, EAC, Piet Levers	216
FE6600 Series Designs: Roses with Single, Double Cylinder with Deadbolt, Non-Keyed, EAC, Piet Levers	217
FE6600 Series Designs: Escutcheons with Single, Double Cylinder with Deadbolt, Non-Keyed, EAC, Piet Levers	218
FE6600 Series Designs: Roses with Single, Double Cylinder with Deadbolt, Non-Keyed, EAC, Piet Levers	219
FE6600 Series Cylinder & Keying Options	220
FE6600 Series Cylinder & Keying Options (Con't), Strike Options	221
FE6600 Series Door Thickness, Options, Thumbturn Options, Strike Options	222

Continued on next page.

Table of Contents

Multi-Point Exit Device Latching System



USA & Canada Prices Effective March 3, 2025

BL6600 Series Multi-Point Latching System:

BL6600 Series Standard Features	223
BL6600 Series: Single Cylinder, Double Cylinder with Deadbolt, Non-Keyed, EAC: ASA, CSA, LSA, NSA, PSA, RSA, NSM, NSN, NSR Levers	224
BL6600 Series Designs: Escutcheons with Single, Double Cylinder with Deadbolt, Non-Keyed, EAC, Georgia, Jackson, Josef, Laszlo, Marc, Salvador Levers	225
BL6600 Series Designs: Roses with Single, Double Cylinder with Deadbolt, Non-Keyed, EAC, Georgia, Jackson, Josef, Laszlo, Marc, Salvador Levers	226
BL6600 Series Designs: Escutcheons with Single, Double Cylinder with Deadbolt, Non-Keyed, EAC, Josef, Georges Levers	227
BL6600 Series Designs: Roses with Single, Double Cylinder with Deadbolt, Non-Keyed, EAC, Josef, Georges Levers	228
BL6600 Series Designs: Escutcheons with Single, Double Cylinder with Deadbolt, Non-Keyed, EAC, Piet Levers	229
BL6600 Series Designs: Roses with Single, Double Cylinder with Deadbolt, Non-Keyed, EAC, Piet Levers	230
BL6600 Series Designs: Escutcheons with Single, Double Cylinder with Deadbolt, Non-Keyed, EAC, Piet Levers	231
BL6600 Series Designs: Roses with Single, Double Cylinder with Deadbolt, Non-Keyed, EAC, Piet Levers	232
BL6600 Series Cylinder & Keying Options	233
BL6600 Series Cylinder & Keying Options (Con't), Strike Options	234
BL6600 Series Door Thickness, Options, Thumbturn Options, Strike Options	235

FE6700 Series Storm Shutter Multi-Point Latching System:

FE6700 Series Standard Features, Ordering Example	236
FE6700 Series Designs	237
FE6700 Series Cylinder & Keying Options	238
FE6700 Series Cylinder & Keying Options (Con't), Shutter Thickness, Shutter Height, Miscellaneous Options	239

MP9800 Series Multi-Point Vertical Rod Lock:

MP9800 Series Standard Features	240
MP9800 Series Levers: Armstrong, Citation, Dirke, Essex, Lustra, Newport, Regis, Princeton, Georgia, Jackson, Josef, Laszlo, Marc, Salvador Levers	241
MP9800 Series Levers: Armstrong, Citation, Dirke, Essex, Lustra, Newport, Regis, Princeton, Georgia, Jackson, Josef, Laszlo, Marc, Salvador Freewheeling Trim, Electromechanical	242
MP9800A Series Levers: Armstrong, Citation, Dirke, Essex, Lustra, Newport, Regis, Princeton, Georgia, Jackson, Josef, Laszlo, Marc, Salvador Levers	243
MP9800A Series Levers: Armstrong, Citation, Dirke, Essex, Lustra, Newport, Regis, Princeton, Georgia, Jackson, Josef, Laszlo, Marc, Salvador Freewheeling Trim, Electromechanical	244
MP9800 Series Piet Levers, Freewheeling Trim, Electromechanical	245
MP9800A Series Piet Levers, Freewheeling Trim, Electromechanical	246
MP9800 Series Josef, Georges Levers, Freewheeling Trim, Electromechanical	247
MP9800A Series Josef, Georges Levers, Freewheeling Trim, Electromechanical	248
MP9800 Series Cylinder Options, Keying Options	249
MP9800 Series Cylinder & Keying Options (Con't) Door Height Options, Door Width Options, Door Thickness, Motorized Electric Latch Retraction	250
MP9800 Series Miscellaneous Options	251
Blank Page	252

FE5400S

Multi-Point Exit Device Latching System



USA & Canada Prices Effective March 3, 2025

Standard Features

Handing

Device is non-handed. Lever trim is handed.

Bar Length

Standard: 36" (914mm) bar fits 30" - 36" (762mm-914mm) door

Door Height

7'0" (2134mm) standard

Door Thickness

1-3/4" (44mm) standard

Stile

Minimum width 4-1/2" (114mm).

Projection

3-1/4" (83mm) active, 2-3/4" (70mm) dogged.

Cylinders

Cylinder not included unless specified.

Warranty

Seven-year limited



Ordering Examples:

Exit Device Only

Quantity	Series/Function	Finish	Hand	Misc. Options
65	FE5400S	626	RHR	M51

Trim Only

Quantity	Trim/Function	Finish	Hand	Door Thickness
24	N959ET	625	RHR	D214

Exit Device with Trim

Qty	Exit Device	Trim/Function	Finish	Hand	Door Thickness	Door Width	Misc. Options
65	FE5400S	N959ET	605	LHR	D214	W048	M51

Contract/Detailed Order — Exit Device with Trim

Qty	Keyset	Exit Device	Trim/Function	Finish	Hand	Door Height	Door Width	Misc. Options	Cylinder Option
36	AA1	FE5400S	C959ET	626	LHR	HO800	W048	M52	7P

Pricing: 36" Device Only

Includes device, strike(s) and screw pack. No cylinder or trim.

FE5400S Series			
Function	Description	Finish: 613E, 630', BSP, WSP	Finish: 605, 606, 611, 612, 613, 618, 619, 625, 626, 629, 722
FE5400S	Panic	\$5,280.00	\$5,360.00
FE5400SA	3 Hour Fire Rated	\$5,529.00	\$5,609.00

Caution: Be sure of your measurements. Exit devices are NOT returnable.

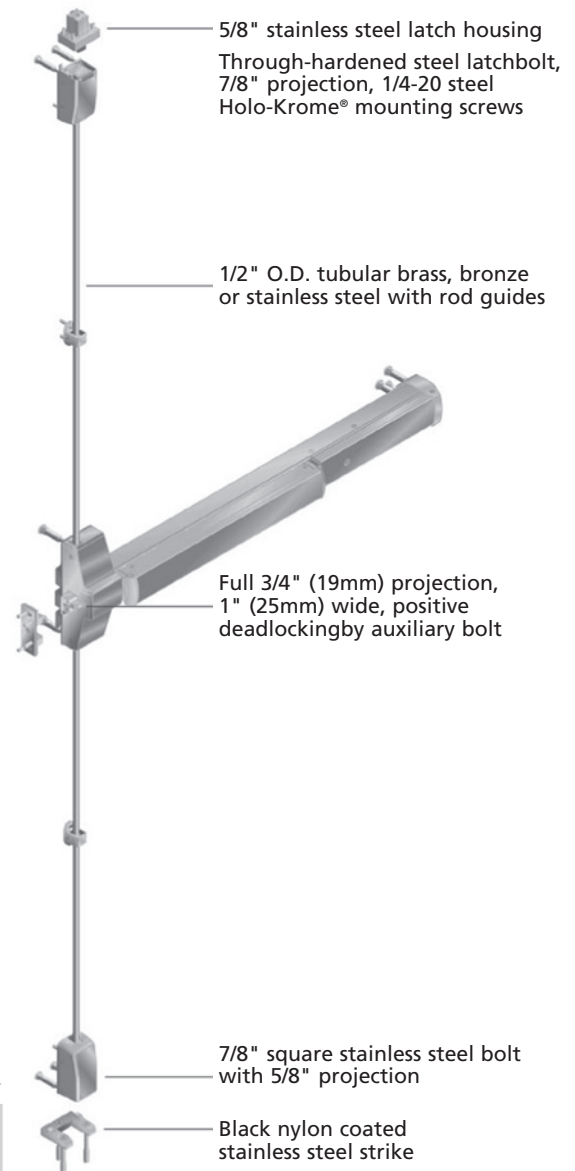

FE5400S

Multi-Point Exit Device Latching System

FE5400S Series Heavy-Duty Trim

USA & Canada Prices Effective March 3, 2025

Cylinder is not included.

Escutcheon Trim Design: A9 Armstrong

Lever: Cast **Escutcheon:** Forged

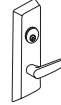

Function	Description	Finish: 605, 606, 611, 612, 613, 613E, 618, 619, 625, 626, 629 ² , 630 ¹ , 722, BSP, WSP
A950ET	Dummy	\$995.00
A955ET	Classroom ³	
A959ET	Storeroom	

Escutcheon Trim Design: C9 Citation

Lever: Cast **Escutcheon:** Forged

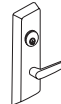

Function	Description	Finish: 605, 606, 611, 612, 613, 613E, 618, 619, 625, 626, 629 ² , 630 ¹ , 722, BSP, WSP
C950ET	Dummy	\$995.00
C955ET	Classroom ³	
C959ET	Storeroom	

Escutcheon Trim Design: D9 Dirke

Lever: Cast **Escutcheon:** Forged

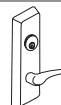

Function	Description	Finish: 605, 606, 611, 612, 613, 613E, 618, 619, 625, 626, 629 ² , 630 ¹ , 722, BSP, WSP
D950ET	Dummy	\$995.00
D955ET	Classroom ³	
D959ET	Storeroom	

Escutcheon Trim Design: E9 Essex

Lever: Cast **Escutcheon:** Forged

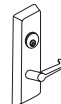

Function	Description	Finish: 605, 606, 611, 612, 613, 613E, 618, 619, 625, 626, 629 ² , 630 ¹ , 722, BSP, WSP
E950ET	Dummy	\$995.00
E955ET	Classroom ³	
E959ET	Storeroom	

Notes:

1. 619 finish provided to match 630 finish
2. 618 finish provided to match 629 finish.
3. Classroom function trim may be converted to storeroom function by a simple field adjustment. No additional parts required.

FE5400S

Multi-Point Exit Device Latching System

FE5400S Series Heavy-Duty Trim

USA & Canada Prices Effective March 3, 2025

Cylinder is not included.

Escutcheon Trim Design: L9 Lustra



Lever: Cast

Escutcheon: Forged

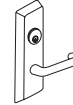

Function	Description	Finish: 605, 606, 611, 612, 613, 613E, 618, 619, 625, 626, 629 ² , 630 ¹ , 722, BSP, WSP
L950ET	Dummy	\$995.00
L955ET	Classroom ³	
L959ET	Storeroom	

Escutcheon Trim Design: N9 Newport



Lever: Cast

Escutcheon: Forged

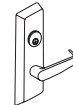

Function	Description	Finish: 605, 606, 611, 612, 613, 613E, 618, 619, 625, 626, 629 ² , 630 ¹ , 722, BSP, WSP
N950ET	Dummy	\$995.00
N955ET	Classroom ³	
N959ET	Storeroom	

Escutcheon Trim Design: R9 Regis



Lever: Cast

Escutcheon: Forged

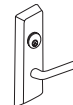

Function	Description	Finish: 605, 606, 611, 612, 613, 613E, 618, 619, 625, 626, 629 ² , 630 ¹ , 722, BSP, WSP
R950ET	Dummy	\$995.00
R955ET	Classroom ³	
R959ET	Storeroom	

Escutcheon Trim Design: PR9 Princeton



Lever: Cast

Escutcheon: Forged

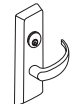

Function	Description	Finish: 605, 606, 611, 612, 613, 613E, 618, 619, 625, 626, 629 ² , 630 ¹ , 722, BSP, WSP
PR950ET	Dummy	\$995.00
PR955ET	Classroom ³	
PR959ET	Storeroom	

Notes:

1. 619 finish provided to match 630 finish. – Escutcheons only.
2. 618 finish provided to match 629 finish. – Escutcheons only.
3. Classroom function trim may be converted to storeroom function by a simple field adjustment. No additional parts required.

FE5400S Multi-Point Exit Device Latching System



FE5400S Series Heavy-Duty Trim

USA & Canada Prices Effective March 3, 2025

Cylinder is not included.

Escutcheon Trim Design: TH900 Pull/Thumbpiece

Grip: Extruded **Escutcheon:** Forged



Function	Description	Finish: 605, 606, 611, 612, 613, 613E, 618, 619, 625, 626, 629 ² , 630 ¹ , 722, BSP
TH950ET	Dummy (No thumbpiece)	\$719.00
TH955ET	Classroom	\$757.00
TH959ET	Storeroom	\$757.00

Escutcheon Trim Design: P9 Pull

Pull: Extruded **Escutcheon:** Forged

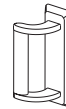

Function	Description	Finish: 605, 606, 611, 612, 613, 613E, 618, 619, 625, 626, 629 ² , 630 ¹ , 722, BSP
P950ET*	Dummy	\$652.00

* Specify Hand. Field Reversible.

FE5400S

Multi-Point Exit Device Latching System

FE5400S Series Heavy-Duty Trim

USA & Canada Prices Effective March 3, 2025

Cylinder is not included.

Escutcheon Trim Design: FR9 Frascati*



Escutcheon: Forged

* Handed Lever. Handing cannot be changed in the field.

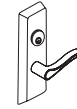

Function	Description	Finish: 605, 606, 611, 612, 613, 613E, 618, 619, 625, 626, 629 ² , 630 ¹ , 722, BSP
FR950ET	Dummy	\$995.00
FR955ET	Classroom ³	
FR959ET	Storeroom	

Escutcheon Trim Design: M9 Merlot



Escutcheon: Forged

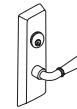

Function	Description	Finish: 605, 606, 611, 612, 613, 613E, 618, 619, 625, 626, 629 ² , 630 ¹ , 722, BSP
M950ET	Dummy	\$995.00
M955ET	Classroom ³	
M959ET	Storeroom	

Escutcheon Trim Design: Z9 Zinfandel*



Escutcheon: Forged

* Handed Lever. Handing cannot be changed in the field.

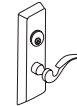

Function	Description	Finish: 605, 606, 611, 612, 613, 613E, 618, 619, 625, 626, 629 ² , 630 ¹ , 722, BSP
Z950ET	Dummy	\$995.00
Z955ET	Classroom ³	
Z959ET	Storeroom	

Notes:

3. Classroom function trim may be converted to storeroom function by a simple field adjustment. No additional parts required.

FE5400S Multi-Point Exit Device Latching System

FE5400S Series Heavy-Duty Trim

USA & Canada Prices Effective March 3, 2025

Cylinder is not included.

Escutcheon Trim Design: Muséo®

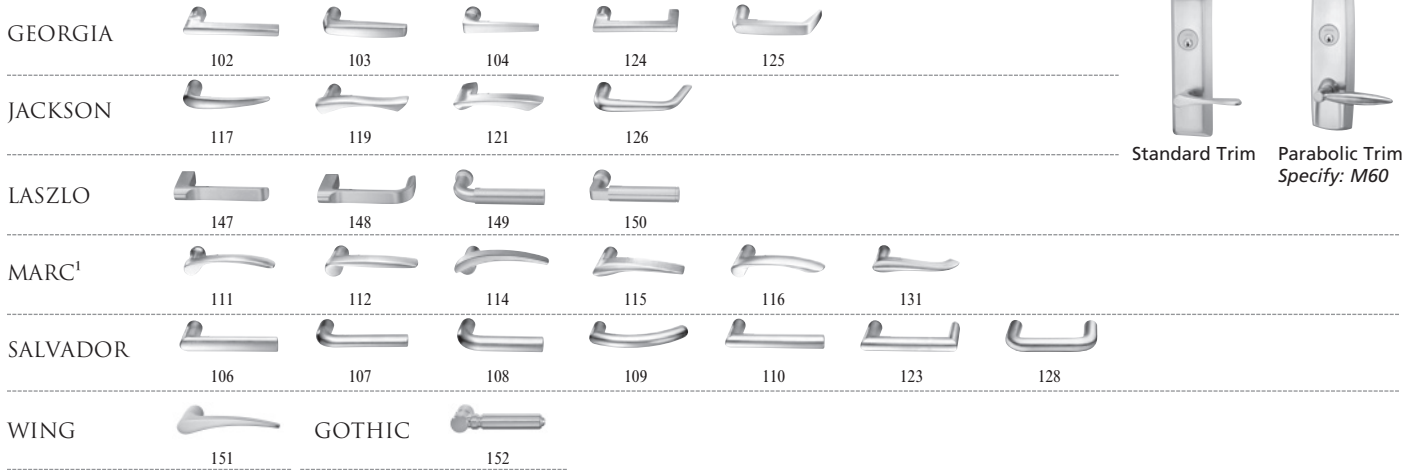

Function	Description	Finish: 605, 606, 611, 612, 613, 613E, 618, 619, 625, 626, 629², 630¹, 722, BSP
950ET	Dummy	\$995.00
955ET	Classroom³	
959ET	Storeroom	

*629 and *630 finish options are Not available for all Muséo levers. Please refer to page 22 for availability.

Escutcheon Trim Design: Muséo®

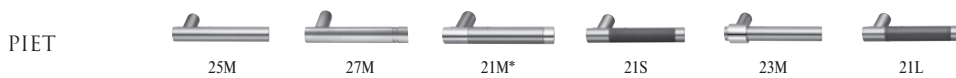

*613E, BSP, WSP finishes are not available with 21M levers.

Function	Description	Finish: 613E, 629, 630, BSP, WSP
950ET	Dummy	\$1,072.00
955ET	Classroom³	
959ET	Storeroom	

Notes:

3. Classroom function trim may be converted to storeroom function by a simple field adjustment. No additional parts required.

FE5400S

Multi-Point Exit Device Latching System

FE5400S Series Electrically Controlled Trim

USA & Canada Prices Effective March 3, 2025

Cylinder is not included.

Escutcheon Trim Design: A9 Armstrong



Lever: Cast **Escutcheon:** Forged

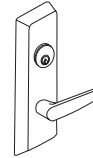

Function	Description	Finish: 605, 606, 611, 612, 613, 613E, 618, 619, 625, 626, 629 ² , 630 ¹ , 722, BSP, WSP
A9905ET*	Fail Secure	\$1,616.00

Escutcheon Trim Design: C9 Citation



Lever: Cast **Escutcheon:** Forged

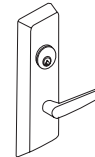

Function	Description	Finish: 605, 606, 611, 612, 613, 613E, 618, 619, 625, 626, 629 ² , 630 ¹ , 722, BSP, WSP
C9905ET*	Fail Secure	\$1,616.00

Escutcheon Trim Design: D9 Dirke*



Lever: Cast **Escutcheon:** Forged

* Handed Lever. Handing cannot be changed in the field.

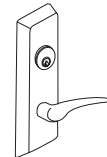

Function	Description	Finish: 605, 606, 611, 612, 613, 613E, 618, 619, 625, 626, 629 ² , 630 ¹ , 722, BSP, WSP
D9905ET*	Fail Secure	\$1,616.00

Escutcheon Trim Design: E9 Essex



Lever: Cast **Escutcheon:** Forged

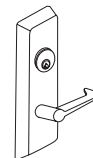

Function	Description	Finish: 605, 606, 611, 612, 613, 613E, 618, 619, 625, 626, 629 ² , 630 ¹ , 722, BSP, WSP
E9905ET*	Fail Secure	\$1,616.00

- Notes:
- 619 finish provided to match 630 finish. - Escutcheons only
 - 618 finish provided to match 629 finish. - Escutcheons only

*ElectroLynx®

As part of their promise to provide innovative, fast and effective high security solutions to their customers, certain ASSA ABLOY Group brands offer *ElectroLynx*®, a universal quick-connect system that simplifies the electrification of the door opening.

FE5400S

Multi-Point Exit Device Latching System

FE5400S Series Electrically Controlled Trim

USA & Canada Prices Effective March 3, 2025

Cylinder is not included.

Escutcheon Trim Design: L9 Lustra

Lever: Cast **Escutcheon:** Forged

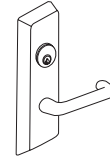

Function	Description	Finish: 605, 606, 611, 612, 613, 613E, 618, 619, 625, 626, 629 ² , 630 ¹ , 722, BSP, WSP
L9905ET*	Fail Secure	\$1,616.00

Escutcheon Trim Design: N9 Newport

Lever: Cast **Escutcheon:** Forged

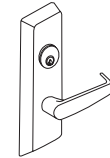

Function	Description	Finish: 605, 606, 611, 612, 613, 613E, 618, 619, 625, 626, 629 ² , 630 ¹ , 722, BSP, WSP
N9905ET*	Fail Secure	\$1,616.00

Escutcheon Trim Design: R9 Regis

Lever: Cast **Escutcheon:** Forged

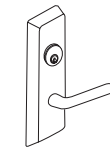

Function	Description	Finish: 605, 606, 611, 612, 613, 613E, 618, 619, 625, 626, 629 ² , 630 ¹ , 722, BSP, WSP
R9905ET*	Fail Secure	\$1,616.00

Escutcheon Trim Design: PR9 Princeton

Lever: Cast **Escutcheon:** Forged

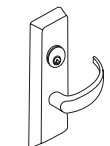

Function	Description	Finish: 605, 606, 611, 612, 613, 613E, 618, 619, 625, 626, 629 ² , 630 ¹ , 722, BSP, WSP
PR9905ET*	Fail Secure	\$1,616.00

Notes:

1. 619 finish provided to match 630 finish. - Escutcheons only
2. 618 finish provided to match 629 finish. - Escutcheons only

***ElectroLynx®**

As part of their promise to provide innovative, fast and effective high security solutions to their customers, certain ASSA ABLOY Group brands offer *ElectroLynx®*, a universal quick-connect system that simplifies the electrification of the door opening.

FE5400S

Multi-Point Exit Device Latching System

FE5400S Series Electrically Controlled Trim

USA & Canada Prices Effective March 3, 2025

Cylinder is not included.

Escutcheon Trim Design: FR9 Frascati

Lever: Cast **Escutcheon:** Forged



Function	Description	Finish: 605, 606, 611, 612, 613, 613E, 618, 619, 625, 626, 629 ² , 630 ¹ , 722, BSP, WSP
FR9905ET*	Fail Secure	\$1,616.00

Escutcheon Trim Design: M9 Merlot

Lever: Cast **Escutcheon:** Forged

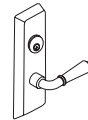

Function	Description	Finish: 605, 606, 611, 612, 613, 613E, 618, 619, 625, 626, 629 ² , 630 ¹ , 722, BSP, WSP
M9905ET*	Fail Secure	\$1,616.00

Escutcheon Trim Design: Z9 Zinfandel

Lever: Cast **Escutcheon:** Forged

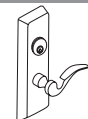

Function	Description	Finish: 605, 606, 611, 612, 613, 613E, 618, 619, 625, 626, 629 ² , 630 ¹ , 722, BSP, WSP
Z9905ET*	Fail Secure	\$1,616.00

*ElectroLynx®

As part of their promise to provide innovative, fast and effective high security solutions to their customers, certain ASSA ABLOY Group brands offer *ElectroLynx*®, a universal quick-connect system that simplifies the electrification of the door opening.

FE5400S































Multi-Point Exit Device Latching System

FE5400S Series Electrically Controlled Trim

USA & Canada Prices Effective March 3, 2025

Cylinder is not included.







Escutcheon Trim Design: Muséo® 

GEORGIA						 Standard Trim  Parabolic Trim <i>Specify: M60</i>		
JACKSON								
LASZLO								
MARC ¹								
SALVADOR								
WING		GOTHIC						

Function	Description	Finish: 605, 606, 611, 612, 613, 613E, 618, 619, 625, 626, 629 ² , 630 ¹ , 722, BSP, WSP
9905ET**	Fail Secure	\$1,616.00

*629 and *630 finish options are Not available for all Muséo levers. Please refer to page 22 for availability.

Escutcheon Trim Design: Muséo® 

PIET						
	25M	27M	21M*	21S	23M	21L

*613E, BSP, WSP finishes are not available with 21M levers.

Function	Description	Finish: 629, 630
9905ET**	Fail Secure	\$1,739.00

**ElectroLynx®

As part of their promise to provide innovative, fast and effective high security solutions to their customers, certain ASSA ABLOY Group brands offer *ElectroLynx*®, a universal quick-connect system that simplifies the electrification of the door opening.

FE5400S Electrically Controlled Trim



Electrified Options

USA & Canada Prices Effective March 3, 2025

Description	Specify Quick Code	Add or Deduct
Touchbar Monitoring or Signaling/Request to Exit (REX)	M92*	Add \$333.00
Outside Trim Monitoring or Signaling	M93*	Add \$333.00
SPDT Lock and Unlock security monitor switch (Electric Trim Only)	M98*	Add \$306.00
Trim gasket for exterior applications (Electric Trim Only)	M99	Add \$34.00

Electrified Accessories

Part Number	Description	Specify	Price
709F649	Power Supply 1 Amp @ 12VDC Output	BPS-12-1	\$543.00
709F659	Power Supply 3 Amp @ 12VDC Output	BPS-12-3	\$1,115.00
709F609	Power Supply 2 Amp @ 24VDC Output	BPS-24-1	\$543.00
709F619	Power Supply 2 Amp @ 24VDC Output	BPS-24-2	\$1,115.00
709F629	Power Supply 4 Amp @ 24VDC Output	BPS-24-4	\$1,868.00
704F288	Concealed transfer (for over 120-degree swing door)	EPTL	\$209.00
709F689	(1) SPDT Maintained Switch (Includes LED)	MKA	\$209.00
709F709	(1) SPDT Momentary Switch (Includes LED)	MK	\$319.00
709F759	(1) SPDT Maintained (Alternating Action) Switch	PB3EA	\$188.00
709F729	DPDT Momentary Key Switch	2' MK2	\$368.00
704F719	Narrow Stile Momentary Key Switch	MKN	\$319.00
709F789	Sonalert 90db @ 2 ft. 12-24VDC Mounted on one gang stainless steel plate.	PZ1	\$159.00

*ElectroLynx®

As part of their promise to provide innovative, fast and effective high security solutions to their customers, certain ASSA ABLOY Group brands offer *ElectroLynx*®, a universal quick-connect system that simplifies the electrification of the door opening.

FE5400S Electrically Controlled Trim Multi-Point Exit Device Latching System



USA & Canada Prices Effective March 3, 2025

Cylinder Options*		
Description	Specify Quick Code	Add or Deduct
Conventional 6-pin	6P**	Add \$130.00 per cylinder
Conventional 7-pin	7P	Add \$132.00 per cylinder
LFIC		
LFIC 6-pin	C6	Add \$242.00 per cylinder
LFIC 6-pin less core	CL6	Add \$130.00 per cylinder
LFIC 6-pin with temporary construction core (Red)	CT6R	Add \$242.00 per cylinder
LFIC 6-pin with temporary construction core (Blue)	CT6B	Add \$242.00 per cylinder
LFIC 6-pin with temporary construction core (Green)	CT6G	Add \$242.00 per cylinder
LFIC 6-pin with temporary disposable core	CT6D	Add \$130.00 per cylinder
LFIC 7-pin	C7	Add \$246.00 per cylinder
LFIC 7-pin less core	CL7	Add \$132.00 per cylinder
LFIC 7-pin with temporary construction core (Red)	CT7R	Add \$246.00 per cylinder
LFIC 7-pin with temporary construction core (Blue)	CT7B	Add \$246.00 per cylinder
LFIC 7-pin with temporary construction core (Green)	CT7G	Add \$246.00 per cylinder
LFIC 7-pin with temporary disposable core	CT7D	Add \$132.00 per cylinder
SFIC		
SFIC 6-pin	C6S	Add \$231.00 per cylinder
SFIC 6-pin with temporary construction core (Blue)	CT6SB	Add \$231.00 per cylinder
SFIC 6-pin with SFIC disposable temporary core	CT6SD	Add \$130.00 per cylinder
SFIC 6-pin with Less Core	CLS6	Add \$130.00 per cylinder
SFIC 7-pin	C7S	Add \$231.00 per cylinder
SFIC 7-pin with temporary construction core (Blue)	CT7SB	Add \$231.00 per cylinder
SFIC 7-pin with SFIC disposable temporary core	CT7SD	Add \$130.00 per cylinder
SFIC 6-pin with Less Core	CLS7	Add \$130.00 per cylinder
Security		
Security	HS	Add \$301.00 per cylinder
Security LFIC	CHS	Add \$409.00 per cylinder
Access 3		
Access 3 Patented	AP	Add \$130.00 per cylinder
Access 3 Security	AS	Add \$214.00 per cylinder
Access 3 High Security, UL 437	AHS	Add \$250.00 per cylinder
Access 3 LFIC Patented	ACP	Add \$242.00 per cylinder
Access 3 LFIC Security	ACS	Add \$326.00 per cylinder
Access 3 LFIC High Security, UL 437	ACHS	Add \$362.00 per cylinder
Pyramid		
Pyramid Security fixed core	PS	Add \$220.00 per cylinder
Pyramid Security LFIC	PCS	Add \$326.00 per cylinder
Pyramid High Security fixed core	PHS	Add \$265.00 per cylinder
Pyramid High Security LFIC	PCHS	Add \$371.00 per cylinder
Pyramid LFIC with temporary construction core	CTP	Add \$242.00 per cylinder
Pyramid LFIC with temporary disposable core	CTPD	Add \$130.00 per cylinder
Pyramid LFIC less core	CLP	Add \$130.00 per cylinder
Keying and Keys		
0-bitted with 2 Blank Keys	(standard)	No Charge
Keyed Random	KR	No Charge
Construction Master Keyed ²	CMK	Add \$16.00 per cylinder
More than 2 Keys	KY# (e.g., KY6)	See page 29 - Cut Keys Section
Master Keying		
Master keyed (all cylinders except CR8000, CR8020, CR8027, CR8200, CR8500, CR8600, CR8700)	MK	Add \$16.00 per cylinder
Master keyed Pyramid (except CR8020, CR8027 LFIC cores)	MK	
Master keyed Security (including LFIC cylinder and core)	MK	
Master keyed Access 3 (except CR8500, CR8600, CR8700 LFIC cores)	MK	
Master keyed (CR8000, CR8020, CR8027, CR8200, CR8500, CR8600, CR8700)	MK-IC	No Charge
Master keyed to customer bittings or sample key	MK-CB	Add \$16.00 per cylinder

Continued on next page

*Optional dogging cylinder will be furnished with the same mechanism and keyed alike with the trim cylinder, unless otherwise specified.

If different keying or cylinder type is required, specify outside (trim) first, then inside (dogging) cylinder.

**6P cylinder option is supplied in 6-pin, L4 keyway, 0-bitted with two nickel silver keys.

*For key bows other than 10 and 90, specify "KB" + bow number as Quick Code, e.g. KB12.

- Notes:
1. CMK Construction master keying charge is in addition to master keying charge.
 2. CMK Construction master keying is not available in interchangeable core, Access 3, Pyramid, or Security series.

FE5400S Electrically Controlled Trim Multi-Point Exit Device Latching System



USA & Canada Prices Effective March 3, 2025

Cylinder Options (continued) & Keying Options*

Visual Cylinder/Key Control (VKC)	Cylinders		Keys	
	Stamping	List Price	Stamping	List Price
VKC0 – No stamping except keyway designation (keys will be tagged)	No Stamping	No Charge	No Stamping	\$5/Cyl
VKC1 – Keys only	N/A	N/A	Keyset	No Charge
VKC2 – Cylinder and keys*	Keyset	\$4/Cyl	Keyset	No Charge
VKC3 – Cylinder*	Keyset	\$4/Cyl	Bittings	No Charge
All VKC, VDC, or VAC stamping codes that use an alternate symbol	Alternate Stamping	\$4/Cyl	Alternate Stamping	\$4/Cyl
Concealed Cylinder/Visual Key Control (CKC)	Cylinders		Keys	
	Stamping	List Price	Stamping	List Price
CKC2 – Cylinder and Keys*	Keyset	\$4/Cyl	Keyset	No Charge
CKC3 – Cylinders only*	Keyset	\$4/Cyl	Bittings	No Charge
All CKC, CDC, or CAC stamping codes that use an alternate symbol	Alternate Stamping	\$4/Cyl	Alternate Stamping	\$4/Cyl

*Cylinder face stamping not available for Access 3, Pyramid, or Security products

Notes: 1. CMK Construction master keying charge is in addition to master keying charge.
2. CMK construction master keying is not available in interchangeable core, Access 3, Pyramid, or Security series.
**For key bows other than 10 and 90, specify 'KB' + bow number as Quick Code, e.g. KB12. No extra charge.

Door Height Options

Door Height	Specify Quick Code	Add or Deduct
7'0"	(standard)	No Charge
7'2"	H0702	No Charge
7'6"	H0706	No Charge
8'0"	H0800	No Charge

Door Width Options

Door Width	Specify Quick Code	Add or Deduct
32"	W032	No Charge
36"	(standard)	No Charge
42"	W042	No Charge
48"	W048	Add \$53.00 per device

Door Thickness Options

Door Thickness	Specify Quick Code	Add or Deduct
1-3/4"	(standard)	No Charge
2"	D200	No Charge
2-1/4"	D214	No Charge

Miscellaneous Options

Description	Specify	Add or Deduct
Knurling outside and inside (Embossed Touchbar - device side)	M20*	Add \$219.00 per device
Knurling outside only (trim side) ¹	M21*	Add \$105.00 per device
Knurling inside only (Embossed Touchbar - device side)	M22*	Add \$114.00 per device
Abrasive coat outside and inside (trim and device)	M23	Add \$135.00 per device
Abrasive coat inside only (device side)	M24	Add \$72.00 per device
Abrasive coat outside only (trim side)	M25	Add \$63.00 per device
PathLite™ Photoluminescent Touchbar cover	M49	Add \$510.00 per device
Less dogging	M51	No Charge
Cylinder dogging (less cylinder)	M52	Add \$136.00 per device
Mullion stabilizer	M57	Add \$73.00 per mullion
Parabolic Design Exit Trim	M60	Add \$115.00 per device
MicroShield® Antimicrobial finish coating	626C	Add \$99.00 (Exit Devices & Trims (ordered separately) Add
MicroShield® Antimicrobial finish coating	630C	\$119.00 (Exit Devices & Outside Trims (ordered together)

1. Not available with Vineyard™ or Muséo® levers.

*All levers provided in a powder coat finish will be supplied with an abrasive coating.

FE5400S

Multi-Point Exit Device Latching System



Removable Mullions

USA & Canada Prices Effective March 3, 2025

Door Height	Description	Specify	Price
Up to 7'2"	Steel Mullion - 3 Hour Fire Rated, Windstorm Certified	CRFE772A ⁴	\$1,785.00
Up to 8'0"	Steel Mullion - 3 Hour Fire Rated, Windstorm Certified	CRFE708A ⁴	\$1,795.00

Note:

- 4. For use with UL listed door assemblies that comply to FEMA 361 and ICC 500.
For the latest listings on compliant door assemblies visit our website at corbinrusswin.com

Options

Description	Specify Quick Code	Add or Deduct
Door frame filler block for double rabbetted frames	M95	Add \$49.00 per mullion
Door frame angle bracket for aluminum frames	M96	Add \$49.00 per mullion

MP6600 Series Multi-Point Locks

USA & Canada Prices Effective March 3, 2025

Door	1-3/4" thick door only – MP6600 Series requires utilizing Ceco Door and Curries doors and frames. McKINNEY® hinges
Mounting	Supplied fasteners are for metal doors with thru-bolts for trim
Hand	Handed; specify RHR, LHR, RH or LH
Lockbody	Unique mortise lockbody assembly used for a variety of applications
Top Bolt	Adjustable stainless steel 3/4" square bolt with 11/16" engagement; 5/16" steel reinforcement plate
Bottom Bolt	Adjustable stainless steel 3/4" square bolt with 5/8" engagement; 1/4" steel reinforcement plate
Center Bolts	Latchbolt is stainless steel with 3/4" projection. One piece, anti-friction reversible catch. Deadbolt is one piece hardened stainless steel with 1" projection
Lock Front	1/8" steel mortise front reinforced with 13/64" thick lock edge stiffener
Center Bolt Strike	1/4" thick stainless steel
Backset	Lever: 2-3/4" standard; Rods: 5-1/4"
Door Thickness	1-3/4" standard
Maximum Opening	Single door 2'8" x 6'8" up to 4'0" x 10'0" and double doors 6'0" x 6'8" up to 8'0" x 10'0" (Double doors require 2-988CR surface bolts)
UL Fire Listed	UL 3-hour fire rating
Trim	Multiple sectional and escutcheon mortise trim with Standard or Muséo levers
Cylinder	Multiple mortise cylinders

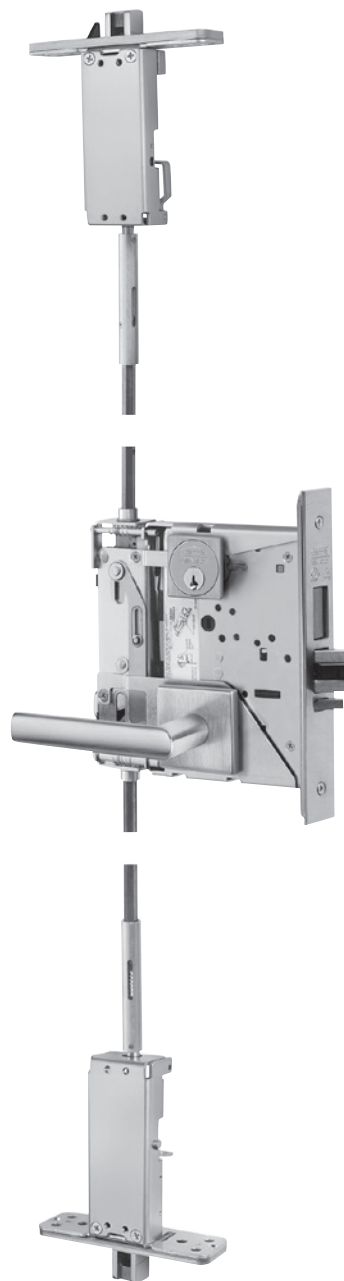

How to Order Ordering Example

Quantity	Series/ Function	Trim	Finish	Hand
100	MP6618	ASM	626	RHR

Note: Concealed vertical rods, top & bottom latches, and the lockbody cassette will be factory installed. All other hardware components are shipped directly to the customer and must be installed by a factory trained installer. Invoices for the door will be separate from the hardware invoice. The hardware invoice will include the concealed vertical assembly and the trim components.

MP6600 Series Multi-Point Locks



USA & Canada Prices Effective March 3, 2025

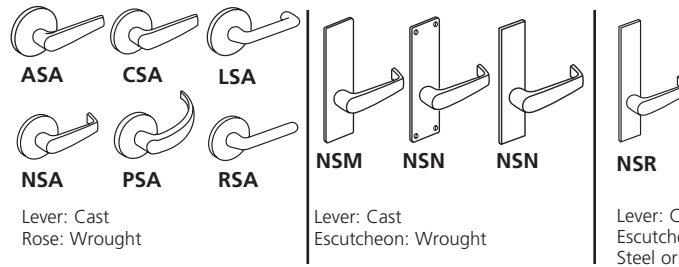

Available Functions	Description	Levers: AS, CS, ES, LS, NS, PS, RS Roses: A, G		Levers: AS, CS, ES, LS, NS, PS, RS Escutcheons: M, N, LW1		Levers: AS, CS, ES, LS, NS, PS, RS Escutcheons: RE1/RE2, RE3/RE4	
		613E, 626, BSP, WSP	605, 606, 611, 612, 613, 618, 619, 625, 629, 630, 722	613E, 626, BSP, WSP	605, 606, 611, 612, 613, 618, 619, 625, 629, 630, 722	613E, 626, BSP, WSP	605, 606, 611, 612, 613, 618, 619, 625, 629, 630, 722
Single Cylinder without Deadbolt							
MP6654 MP6655 MP6666 MP6656	Office/Entry Classroom Office & Inner Entry Lock Holdback	\$4,950.00	\$4,974.00	\$4,970.00	\$4,994.00	\$5,024.00	\$5,048.00
Single Cylinder with Deadbolt							
MP6618 MP6624 MP6665 MP6627	Classroom Storeroom Exit/Dormitory Closet or Storeroom	\$4,950.00	\$4,974.00	\$4,970.00	\$4,994.00	\$5,024.00	\$5,048.00
Non-Keyed							
MP6680 MP6609 MP6630 MP6620 MP6610 MP6660	Inside Passage Passage Privacy Bath Privacy Bedroom Passage or Closet Privacy Bath/Bedroom	\$4,950.00	\$4,974.00	\$4,970.00	\$4,994.00	\$5,024.00	\$5,048.00
Double Cylinder with Deadbolt							
MP6622 MP6662 MP6672 MP6673 MP6675	Store Door Classroom Security Intruder Deadbolt Classroom Security Intruder Aux. Deadbolt Classroom Security Intruder Deadlatch Security Deadbolt	\$4,950.00	\$4,974.00	\$4,970.00	\$4,994.00	\$5,024.00	\$5,048.00
Double Cylinder without Deadbolt							
MP6652 MP6691	Classroom Security Intruder Latchbolt Classroom Security Holdback	\$4,950.00	\$4,974.00	\$4,970.00	\$4,994.00	\$5,024.00	\$5,048.00
EAC							
MP66609 x NAC SAF / SEC	No Key Override With Deadbolt Fail Safe/Secure 12V/24V	\$5,256.00	\$5,280.00	\$5,276.00	\$5,300.00	\$5,330.00	\$5,354.00
MP66608 x NAC SAF / SEC	Key Override With Deadbolt Fail Safe/Secure 12V/24V	\$5,458.00	\$5,482.00	\$5,478.00	\$5,502.00	\$5,532.00	\$5,556.00
MP66932 SAF / SEC	NAC Fail Safe/Secure Lock, 12/24 Volt	\$5,256.00	\$5,280.00	\$5,276.00	\$5,300.00	\$5,330.00	\$5,354.00
MP66606 SAF / SEC	NAC Key Override And No Deadbolt Fail Safe/Secure 12V/24V	\$5,334.00	\$5,358.00	\$5,354.00	\$5,378.00	\$5,408.00	\$5,432.00
MP66934	NAC No Deadbolt And Key Override	\$5,458.00	\$5,482.00	\$5,478.00	\$5,502.00	\$5,532.00	\$5,556.00
MP66733	NAC No Deadbolt And No Key Override	\$5,379.00	\$5,403.00	\$5,399.00	\$5,423.00	\$5,453.00	\$5,477.00

MP6600 Series Multi-Point Locks



USA & Canada Prices Effective March 3, 2025

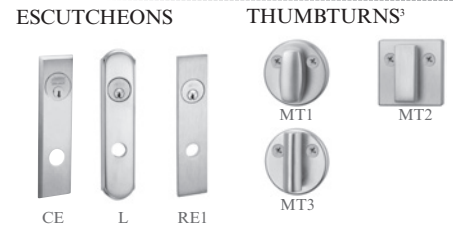
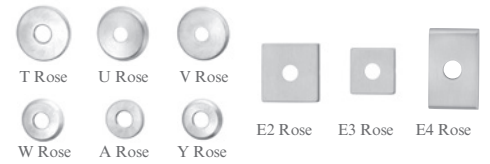
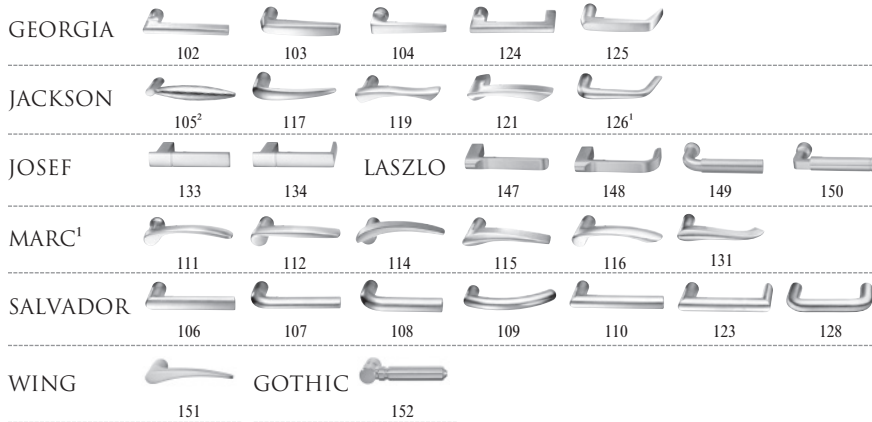

1. Handed: specify hand when ordering
2. Contact factory for current lead time
3. Specify thumbturn as quick code. Thumbturn backplate will match shape of rose chosen (i.e. round or square). Not available with escutcheons.

*629 and *630 finish options are Not available for all Muséo levers. Please refer to page 22 for availability.

613E	Dark Oxidized Satin Bronze - Equivalent	605	Bright Brass, Clear Coated	618	Bright Nickel Plated
626	Satin Chromium Plated	606	Satin Brass, Clear Coated	619	Satin Nickel Plated
BSP	Black Suede Powder Coat	611	Bright Bronze, Clear Coated	625	Bright Chromium Plated
WSP	White Suede Powder Coat	612	Satin Bronze, Clear Coated	629*	Bright Stainless Steel
		613	Dark Oxidized Satin Bronze, Oil Rubbed	630*	Satin Stainless Steel
		613L	Dark Oxidized Satin Bronze, Clear Coated	722	Black Oxidized Bronze, Oil Rubbed

Functions	Description		
Single Cylinder without Deadbolt ESCUTCHEONS: L, CE, RE1			
MP6654 MP6655 MP6666 MP6656	Office/Entry Classroom Office & Inner Entry Lock Holdback	\$5,004.00	\$5,028.00
Single Cylinder with Deadbolt ESCUTCHEONS: L, CE, RE1			
MP6618 MP6624 MP6665 MP6627	Classroom Storeroom Exit/Dormitory Closet or Storeroom	\$5,004.00	\$5,028.00
Non-Keyed ESCUTCHEONS: L, CE, RE1			
MP6680 MP6609 MP6630 MP6620 MP6610 MP6660	Inside Passage Passage Privacy Bath Privacy Bedroom Passage or Closet Privacy Bath/Bedroom	\$5,004.00	\$5,028.00
Double Cylinder with Deadbolt ESCUTCHEONS: L, CE, RE1			
MP6622 MP6662 MP6672 MP6673 MP6675	Store Door Classroom Security Intruder Deadbolt Classroom Security Intruder Auxiliary Deadbolt Classroom Security Intruder Deadlatch Security Deadbolt	\$5,004.00	\$5,028.00
Double Cylinder without Deadbolt ESCUTCHEONS: L, CE, RE1			
MP6652 MP6691	Classroom Security Intruder Latchbolt Classroom Security Holdback	\$5,004.00	\$5,028.00
EAC ESCUTCHEONS: L, CE, RE1			
MP66609 x NAC SAF / SEC	No Key Override With Deadbolt Fail Safe/Secure 12V/24V	\$5,310.00	\$5,334.00
MP66608 x NAC SAF / SEC	Key Override With Deadbolt Fail Safe/Secure 12V/24V	\$5,512.00	\$5,536.00
MP66932 SAF / SEC	NAC Fail Safe/Secure Lock, 12/24 Volt	\$5,310.00	\$5,334.00
MP66606 SAF / SEC	NAC Key Override And No Deadbolt Fail Safe/Secure 12V/24V	\$5,388.00	\$5,412.00
MP66934	NAC No Deadbolt And Key Override	\$5,512.00	\$5,536.00
MP66733	NAC No Deadbolt And No Key Override	\$5,433.00	\$5,457.00

Experience a safer
and more open world

MP6600 Series Multi-Point Locks

USA & Canada Prices Effective March 3, 2025

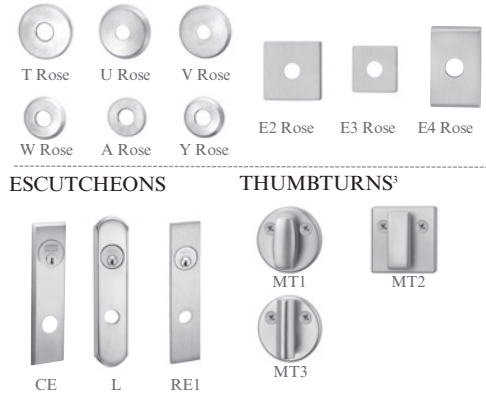
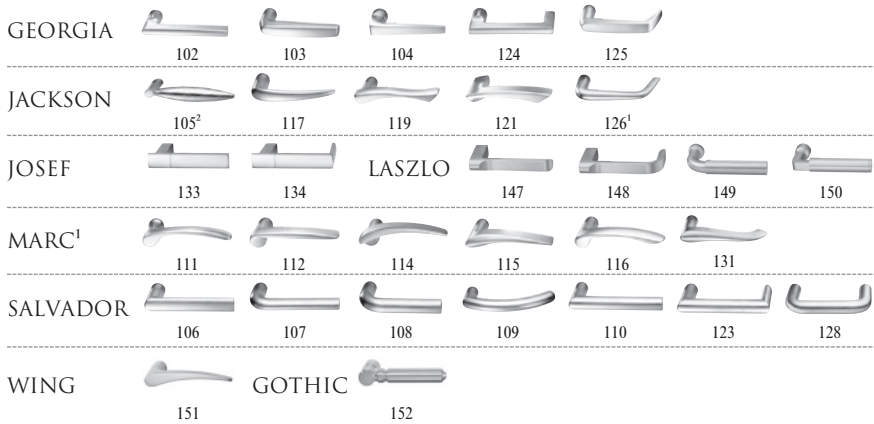

1. Handed: specify hand when ordering
2. Contact factory for current lead time
3. Specify thumbturn as quick code. Thumbturn backplate will match shape of rose chosen (i.e. round or square). Not available with escutcheons.

*629 and *630 finish options are Not available for all Muséo levers. Please refer to page 22 for availability.

613E	Dark Oxidized Satin Bronze	- Equivalent	605	Bright Brass, Clear Coated	618	Bright Nickel Plated
626	Satin Chromium Plated		606	Satin Brass, Clear Coated	619	Satin Nickel Plated
BSP	Black Suede Powder Coat		611	Bright Bronze, Clear Coated	625	Bright Chromium Plated
WSP	White Suede Powder Coat		612	Satin Bronze, Clear Coated	629*	Bright Stainless Steel
			613	Dark Oxidized Satin Bronze, Oil Rubbed	630*	Satin Stainless Steel
			613L	Dark Oxidized Satin Bronze, Clear Coated	722	Black Oxidized Bronze, Oil Rubbed

Functions	Description		
Single Cylinder without Deadbolt ROSES: A, T, U, V, W, Y, E2, E3, E4			
MP6654 MP6655 MP6666 MP6656	Office/Entry Classroom Office & Inner Entry Lock Holdback	\$4,950.00	\$4,974.00
Single Cylinder with Deadbolt ROSES: A, T, U, V, W, Y, E2, E3, E4			
MP6618 MP6624 MP6665 MP6627	Classroom Storeroom Exit/Dormitory Closet or Storeroom	\$4,950.00	\$4,974.00
Non-Keyed ROSES ROSES: A, T, U, V, W, Y, E2, E3, E4			
MP6680 MP6609 MP6630 MP6620 MP6610 MP6660	Inside Passage Passage Privacy Bath Privacy Bedroom Passage or Closet Privacy Bath/Bedroom	\$4,950.00	\$4,974.00
Double Cylinder with Deadbolt ROSES: A, T, U, V, W, Y, E2, E3, E4			
MP6622 MP6662 MP6672 MP6673 MP6675	Store Door Classroom Security Intruder Deadbolt Classroom Security Intruder Auxiliary Deadbolt Classroom Security Intruder Deadlatch Security Deadbolt	\$4,950.00	\$4,974.00
Double Cylinder without Deadbolt ROSES: A, T, U, V, W, Y, E2, E3, E4			
MP6652 MP6691	Classroom Security Intruder Latchbolt Classroom Security Holdback	\$4,950.00	\$4,974.00
EAC ROSES: A, T, U, V, W, Y, E2, E3, E4			
MP66609 x NAC SAF / SEC	No Key Override With Deadbolt Fail Safe/Secure 12V/24V	\$5,256.00	\$5,280.00
MP66608 x NAC SAF / SEC	Key Override With Deadbolt Fail Safe/Secure 12V/24V	\$5,458.00	\$5,482.00
MP66932 SAF / SEC	NAC Fail Safe/Secure Lock, 12/24 Volt	\$5,256.00	\$5,280.00
MP66606 SAF / SEC	NAC Key Override And No Deadbolt Fail Safe/Secure 12V/24V	\$5,334.00	\$5,358.00
MP66934	NAC No Deadbolt And Key Override	\$5,458.00	\$5,482.00
MP66733	NAC No Deadbolt And No Key Override	\$5,379.00	\$5,403.00

MP6600 Series Multi-Point Locks

USA & Canada Prices Effective March 3, 2025

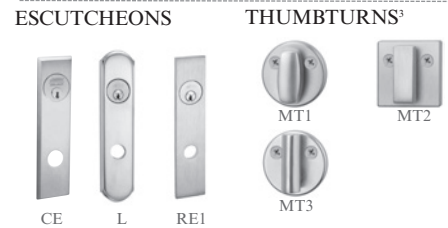
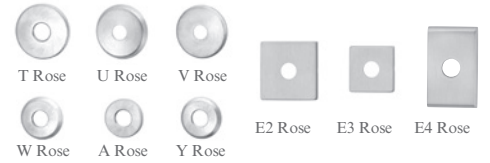
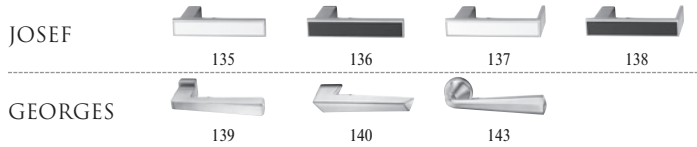

1. Handed: specify hand when ordering
2. Contact factory for current lead time
3. Specify thumbturn as quick code. Thumbturn backplate will match shape of rose chosen (i.e. round or square). Not available with escutcheons.

613E	Dark Oxidized Satin Bronze	605	Bright Brass, Clear Coated	618	Bright Nickel Plated
626	Satin Chromium Plated	606	Satin Brass, Clear Coated	619	Satin Nickel Plated
BSP	Black Suede Powder Coat	611	Bright Bronze, Clear Coated	625	Bright Chromium Plated
WSP	White Suede Powder Coat	612	Satin Bronze, Clear Coated	629	Bright Stainless Steel
		613	Dark Oxidized Satin Bronze, Oil Rubbed	630	Satin Stainless Steel
		613L	Dark Oxidized Satin Bronze, Clear Coated	722	Black Oxidized Bronze, Oil Rubbed

Functions	Description		
Single Cylinder without Deadbolt ESCUTCHEONS: L, CE, RE1			
MP6654 MP6655 MP6666 MP6656	Office/Entry Classroom Office & Inner Entry Lock Holdback	\$5,130.00	\$5,154.00
Single Cylinder with Deadbolt ESCUTCHEONS: L, CE, RE1			
MP6618 MP6624 MP6665 MP6627	Classroom Storeroom Exit/Dormitory Closet or Storeroom	\$5,130.00	\$5,154.00
Non-Keyed ESCUTCHEONS: L, CE, RE1			
MP6680 MP6609 MP6630 MP6620 MP6610 MP6660	Inside Passage Passage Privacy Bath Privacy Bedroom Passage or Closet Privacy Bath/Bedroom	\$5,130.00	\$5,154.00
Double Cylinder with Deadbolt ESCUTCHEONS: L, CE, RE1			
MP6622 MP6662 MP6672 MP6673 MP6675	Store Door Classroom Security Intruder Deadbolt Classroom Security Intruder Auxiliary Deadbolt Classroom Security Intruder Deadlatch Security Deadbolt	\$5,130.00	\$5,154.00
Double Cylinder without Deadbolt ESCUTCHEONS: L, CE, RE1			
MP6652 MP6691	Classroom Security Intruder Latchbolt Classroom Security Holdback	\$5,130.00	\$5,154.00
EAC ESCUTCHEONS: L, CE, RE1			
MP66609 x NAC SAF / SEC	No Key Override With Deadbolt Fail Safe/Secure 12V/24V	\$5,436.00	\$5,460.00
MP66608 x NAC SAF / SEC	Key Override With Deadbolt Fail Safe/Secure 12V/24V	\$5,638.00	\$5,662.00
MP66932 SAF / SEC	NAC Fail Safe/Secure Lock, 12/24 Volt	\$5,436.00	\$5,460.00
MP66606 SAF / SEC	NAC Key Override And No Deadbolt Fail Safe/Secure 12V/24V	\$5,514.00	\$5,538.00
MP66934	NAC No Deadbolt And Key Override	\$5,638.00	\$5,662.00
MP66733	NAC No Deadbolt And No Key Override	\$5,559.00	\$5,583.00

MP6600 Series Multi-Point Locks

USA & Canada Prices Effective March 3, 2025

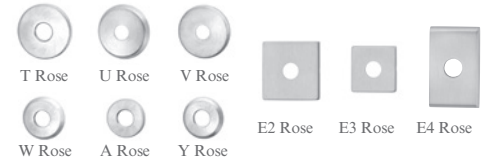
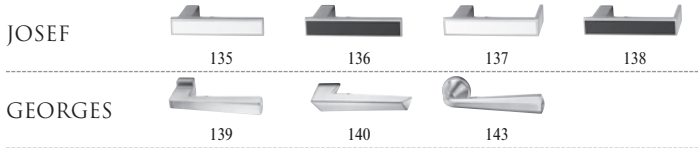

ESCUTCHEONS **THUMBTURNS³**



1. Handed: specify hand when ordering
2. Contact factory for current lead time
3. Specify thumbturn as quick code. Thumbturn backplate will match shape of rose chosen (i.e. round or square). Not available with escutcheons.

613E	Dark Oxidized Satin Bronze	605	Bright Brass, Clear Coated	618	Bright Nickel Plated
	- Equivalent	606	Satin Brass, Clear Coated	619	Satin Nickel Plated
626	Satin Chromium Plated	611	Bright Bronze, Clear Coated	625	Bright Chromium Plated
BSP	Black Suede Powder Coat	612	Satin Bronze, Clear Coated	629	Bright Stainless Steel
WSP	White Suede Powder Coat	613	Dark Oxidized Satin Bronze, Oil Rubbed	630	Satin Stainless Steel
		613L	Dark Oxidized Satin Bronze, Clear Coated	722	Black Oxidized Bronze, Oil Rubbed

Functions	Description		
Single Cylinder without Deadbolt ROSES: A, T, U, V, W, Y, E2, E3, E4			
MP6654 MP6655 MP6666 MP6656	Office/Entry Classroom Office & Inner Entry Lock Holdback	\$5,076.00	\$5,100.00
Single Cylinder with Deadbolt ROSES: A, T, U, V, W, Y, E2, E3, E4			
MP6618 MP6624 MP6665 MP6627	Classroom Storeroom Exit/Dormitory Closet or Storeroom	\$5,076.00	\$5,100.00
Non-Keyed ROSES: A, T, U, V, W, Y, E2, E3, E4			
MP6680 MP6609 MP6630 MP6620 MP6610 MP6660	Inside Passage Passage Privacy Bath Privacy Bedroom Passage or Closet Privacy Bath/Bedroom	\$5,076.00	\$5,100.00
Double Cylinder with Deadbolt ROSES: A, T, U, V, W, Y, E2, E3, E4			
MP6622 MP6662 MP6672 MP6673 MP6675	Store Door Classroom Security Intruder Deadbolt Classroom Security Intruder Auxiliary Deadbolt Classroom Security Intruder Deadlatch Security Deadbolt	\$5,076.00	\$5,100.00
Double Cylinder without Deadbolt ROSES: A, T, U, V, W, Y, E2, E3, E4			
MP6652 MP6691	Classroom Security Intruder Latchbolt Classroom Security Holdback	\$5,076.00	\$5,100.00
EAC ROSES: A, T, U, V, W, Y, E2, E3, E4			
MP66609 x NAC SAF / SEC	No Key Override With Deadbolt Fail Safe/Secure 12V/24V	\$5,382.00	\$5,406.00
MP66608 x NAC SAF / SEC	Key Override With Deadbolt Fail Safe/Secure 12V/24V	\$5,584.00	\$5,608.00
MP66932 SAF / SEC	NAC Fail Safe/Secure Lock, 12/24 Volt	\$5,382.00	\$5,406.00
MP66606 SAF / SEC	NAC Key Override And No Deadbolt Fail Safe/Secure 12V/24V	\$5,460.00	\$5,484.00
MP66934	NAC No Deadbolt And Key Override	\$5,584.00	\$5,608.00
MP66733	NAC No Deadbolt And No Key Override	\$5,505.00	\$5,529.00

MP6600 Series Multi-Point Locks



USA & Canada Prices Effective March 3, 2025



*613E, BSP, WSP finishes are not available with 21M levers.

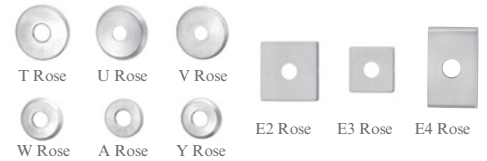

ESCUTCHEONS THUMBTURNS³



Specify thumbturn as quick code. Thumbturn backplate will match shape of rose chosen (i.e. round or square)

- 613E Dark Oxidized Satin Bronze – Equivalent
- 629 Bright Stainless Steel
- 630 Satin Stainless Steel
- BSP Black Suede Powder Coat
- WSP White Suede Powder Coat

Functions	Description	
Single Cylinder without Deadbolt ESCUTCHEONS: L, CE, RE1		
MP6654 MP6655 MP6666 MP6656	Office/Entry Classroom Office & Inner Entry Lock Holdback	\$5,124.00
Single Cylinder with Deadbolt ESCUTCHEONS: L, CE, RE1		
MP6618 MP6624 MP6665 MP6627	Classroom Storeroom Exit/Dormitory Closet or Storeroom	\$5,124.00
Non-Keyed ESCUTCHEONS: L, CE, RE1		
MP6680 MP6609 MP6630 MP6620 MP6610 MP6660	Inside Passage Passage Privacy Bath Privacy Bedroom Passage or Closet Privacy Bath/Bedroom	\$5,124.00
Double Cylinder with Deadbolt ESCUTCHEONS: L, CE, RE1		
MP6622 MP6662 MP6672 MP6673 MP6675	Store Door Classroom Security Intruder Deadbolt Classroom Security Intruder Auxiliary Deadbolt Classroom Security Intruder Deadlatch Security Deadbolt	\$5,124.00
Double Cylinder without Deadbolt ESCUTCHEONS: L, CE, RE1		
MP6652 MP6691	Classroom Security Intruder Latchbolt Classroom Security Holdback	\$5,124.00
EAC ESCUTCHEONS: L, CE, RE1		
MP66609 x NAC SAF / SEC	No Key Override With Deadbolt Fail Safe/Secure 12V/24V	\$5,430.00
MP66608 x NAC SAF / SEC	Key Override With Deadbolt Fail Safe/Secure 12V/24V	\$5,632.00
MP66932 SAF / SEC	NAC Fail Safe/Secure Lock, 12/24 Volt	\$5,430.00
MP66606 SAF / SEC	NAC Key Override And No Deadbolt Fail Safe/Secure 12V/24V	\$5,508.00
MP66934	NAC No Deadbolt And Key Override	\$5,632.00
MP66733	NAC No Deadbolt And No Key Override	\$5,553.00

MP6600 Series Multi-Point Locks

USA & Canada Prices Effective March 3, 2025



*613E, BSP, WSP finishes are not available with 21M levers.

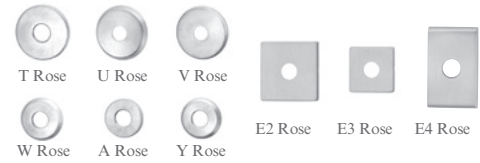

ESCUTCHEONS

THUMBTURNS³



Specify thumbturn as quick code. Thumbturn backplate will match shape of rose chosen (i.e. round or square)

- 613E Dark Oxidized Satin Bronze – Equivalent
- 629 Bright Stainless Steel
- 630 Satin Stainless Steel
- BSP Black Suede Powder Coat
- WSP White Suede Powder Coat

Functions	Description	
Single Cylinder without Deadbolt ROSES: A, T, U, V, W, Y, E2, E3, E4		
MP6654 MP6655 MP6666 MP6656	Office/Entry Classroom Office & Inner Entry Lock Holdback	\$5,070.00
Single Cylinder with Deadbolt ROSES: A, T, U, V, W, Y, E2, E3, E4		
MP6618 MP6624 MP6665 MP6627	Classroom Storeroom Exit/Dormitory Closet or Storeroom	\$5,070.00
Non-Keyed ROSES: A, T, U, V, W, Y, E2, E3, E4		
MP6680 MP6609 MP6630 MP6620 MP6610 MP6660	Inside Passage Passage Privacy Bath Privacy Bedroom Passage or Closet Privacy Bath/Bedroom	\$5,070.00
Double Cylinder with Deadbolt ROSES: A, T, U, V, W, Y, E2, E3, E4		
MP6622 MP6662 MP6672 MP6673 MP6675	Store Door Classroom Security Intruder Deadbolt Classroom Security Intruder Auxiliary Deadbolt Classroom Security Intruder Deadlatch Security Deadbolt	\$5,070.00
Double Cylinder without Deadbolt ROSES: A, T, U, V, W, Y, E2, E3, E4		
MP6652 MP6691	Classroom Security Intruder Latchbolt Classroom Security Holdback	\$5,070.00
EAC ROSES: A, T, U, V, W, Y, E2, E3, E4		
MP66609 x NAC SAF / SEC	No Key Override With Deadbolt Fail Safe/Secure 12V/24V	\$5,376.00
MP66608 x NAC SAF / SEC	Key Override With Deadbolt Fail Safe/Secure 12V/24V	\$5,578.00
MP66932 SAF / SEC	NAC Fail Safe/Secure Lock, 12/24 Volt	\$5,376.00
MP66606 SAF / SEC	NAC Key Override And No Deadbolt Fail Safe/Secure 12V/24V	\$5,454.00
MP66934	NAC No Deadbolt And Key Override	\$5,578.00
MP66733	NAC No Deadbolt And No Key Override	\$5,499.00

MP6600 Series Multi-Point Locks



USA & Canada Prices Effective March 3, 2025

PIET

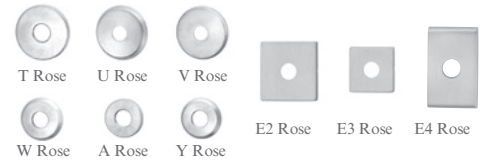

ESCUTCHEONS

THUMBTURNS³



Specify thumbturn as quick code. Thumbturn backplate will match shape of rose chosen (i.e. round or square)

- 613E Dark Oxidized Satin Bronze – Equivalent
- 629 Bright Stainless Steel
- 630 Satin Stainless Steel
- BSP Black Suede Powder Coat
- WSP White Suede Powder Coat

Functions	Description	
Single Cylinder without Deadbolt ESCUTCHEONS: L, CE, RE1		
MP6654 MP6655 MP6666 MP6656	Office/Entry Classroom Office & Inner Entry Lock Holdback	\$5,154.00
Single Cylinder with Deadbolt ESCUTCHEONS: L, CE, RE1		
MP6618 MP6624 MP6665 MP6627	Classroom Storeroom Exit/Dormitory Closet or Storeroom	\$5,154.00
Non-Keyed ESCUTCHEONS: L, CE, RE1		
MP6680 MP6609 MP6630 MP6620 MP6610 MP6660	Inside Passage Passage Privacy Bath Privacy Bedroom Passage or Closet Privacy Bath/Bedroom	\$5,154.00
Double Cylinder with Deadbolt ESCUTCHEONS: L, CE, RE1		
MP6622 MP6662 MP6672 MP6673 MP6675	Store Door Classroom Security Intruder Deadbolt Classroom Security Intruder Auxiliary Deadbolt Classroom Security Intruder Deadlatch Security Deadbolt	\$5,154.00
Double Cylinder without Deadbolt ESCUTCHEONS: L, CE, RE1		
MP6652 MP6691	Classroom Security Intruder Latchbolt Classroom Security Holdback	\$5,154.00
EAC ESCUTCHEONS: L, CE, RE1		
MP66609 x NAC SAF / SEC	No Key Override With Deadbolt Fail Safe/Secure 12V/24V	\$5,460.00
MP66608 x NAC SAF / SEC	Key Override With Deadbolt Fail Safe/Secure 12V/24V	\$5,662.00
MP66932 SAF / SEC	NAC Fail Safe/Secure Lock, 12/24 Volt	\$5,460.00
MP66606 SAF / SEC	NAC Key Override And No Deadbolt Fail Safe/Secure 12V/24V	\$5,538.00
MP66934	NAC No Deadbolt And Key Override	\$5,662.00
MP66733	NAC No Deadbolt And No Key Override	\$5,583.00

MP6600 Series Multi-Point Locks

USA & Canada Prices Effective March 3, 2025

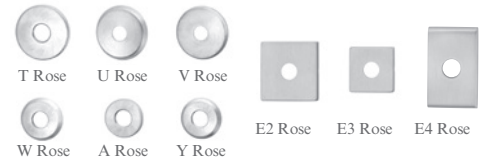
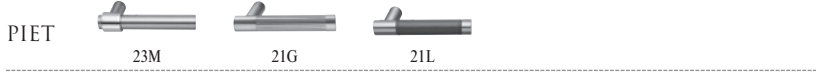

ESCUTCHEONS THUMBTURNS³



Specify thumbturn as quick code. Thumbturn backplate will match shape of rose chosen (i.e. round or square)

613E	Dark Oxidized Satin Bronze – Equivalent
629	Bright Stainless Steel
630	Satin Stainless Steel
BSP	Black Suede Powder Coat
WSP	White Suede Powder Coat

Functions	Description	
Single Cylinder without Deadbolt ROSES: A, T, U, V, W, Y, E2, E3, E4		
MP6654 MP6655 MP6666 MP6656	Office/Entry Classroom Office & Inner Entry Lock Holdback	\$5,100.00
Single Cylinder with Deadbolt ROSES: A, T, U, V, W, Y, E2, E3, E4		
MP6618 MP6624 MP6665 MP6627	Classroom Storeroom Exit/Dormitory Closet or Storeroom	\$5,100.00
Non-Keyed ROSES: A, T, U, V, W, Y, E2, E3, E4		
MP6680 MP6609 MP6630 MP6620 MP6610 MP6660	Inside Passage Passage Privacy Bath Privacy Bedroom Passage or Closet Privacy Bath/Bedroom	\$5,100.00
Double Cylinder with Deadbolt ROSES: A, T, U, V, W, Y, E2, E3, E4		
MP6622 MP6662 MP6672 MP6673 MP6675	Store Door Classroom Security Intruder Deadbolt Classroom Security Intruder Auxiliary Deadbolt Classroom Security Intruder Deadlatch Security Deadbolt	\$5,100.00
Double Cylinder without Deadbolt ROSES: A, T, U, V, W, Y, E2, E3, E4		
MP6652 MP6691	Classroom Security Intruder Latchbolt Classroom Security Holdback	\$5,100.00
EAC ROSES: A, T, U, V, W, Y, E2, E3, E4		
MP66609 x NAC SAF / SEC	No Key Override With Deadbolt Fail Safe/Secure 12V/24V	\$5,406.00
MP66608 x NAC SAF / SEC	Key Override With Deadbolt Fail Safe/Secure 12V/24V	\$5,608.00
MP66932 SAF / SEC	NAC Fail Safe/Secure Lock, 12/24 Volt	\$5,406.00
MP66606 SAF / SEC	NAC Key Override And No Deadbolt Fail Safe/Secure 12V/24V	\$5,484.00
MP66934	NAC No Deadbolt And Key Override	\$5,608.00
MP66733	NAC No Deadbolt And No Key Override	\$5,529.00

MP6600 Series Multi-Point Locks



USA & Canada Prices Effective March 3, 2025

Cylinder Options		
Description	Specify Quick Code	Add or Deduct
Conventional 6-pin	(standard)	No Charge
Conventional 7-pin	7P	Add \$2.00 per cylinder
Less Standard Cylinder	LC	Deduct \$130.00 per cylinder
Less Concealed Shell Cylinder	PO-LC	Add \$5.00 per lockset
LFIC		
LFIC 6-pin	C6	Add \$112.00 per cylinder
LFIC 6-pin Less Core	CL6	No Charge
LFIC 6-pin with Temporary Construction Core (Red)	CT6R	Add \$112.00 per cylinder
LFIC 6-pin with Temporary Construction Core (Blue)	CT6B	Add \$112.00 per cylinder
LFIC 6-pin with Temporary Construction Core (Green)	CT6G	Add \$112.00 per cylinder
LFIC 6-pin with Temporary Disposable Core	CT6D	No Charge
LFIC 7-pin	C7	Add \$114.00 per cylinder
LFIC 7-pin Less Core	CL7	Add \$2.00 per cylinder
LFIC 7-pin with Temporary Construction Core (Red)	CT7R	Add \$114.00 per cylinder
LFIC 7-pin with Temporary Construction Core (Blue)	CT7B	Add \$114.00 per cylinder
LFIC 7-pin with Temporary Construction Core (Green)	CT7G	Add \$114.00 per cylinder
LFIC 7-pin with Temporary Disposable Core	CT7D	Add \$2.00 per cylinder
SFIC		
SFIC 6-pin	C6S	Add \$101.00 per cylinder
SFIC 6-pin with Temporary Construction Core (Blue)	CT6SB	Add \$101.00 per cylinder
SFIC 6-pin with SFIC Disposable Temporary Core	CT6SD	No Charge
SFIC 6-pin with Less Core	CLS6	No Charge
SFIC 7-pin	C7S	Add \$101.00 per cylinder
SFIC 7-pin with Temporary Construction Core (Blue)	CT7SB	Add \$101.00 per cylinder
SFIC 7-pin with SFIC Disposable Temporary Core	CT7SD	No Charge
SFIC 6-pin with Less Core	CLS7	No Charge
Security		
Security ⁴	HS	Add \$171.00 per cylinder
Security LFIC ^{1,4}	CHS	Add \$279.00 per cylinder
Access 3		
Access 3 Patented	AP	No Charge
Access 3 Security	AS	Add \$84.00 per cylinder
Access 3 High Security, UL 437	AHS	Add \$120.00 per cylinder
Access 3 LFIC Patented	ACP	Add \$112.00 per cylinder
Access 3 LFIC Security	ACS	Add \$196.00 per cylinder
Access 3 LFIC High Security, UL 437	ACHS	Add \$232.00 per cylinder
Pyramid		
Pyramid Security Fixed Core	PS	Add \$90.00 per cylinder
Pyramid Security LFIC	PCS	Add \$196.00 per cylinder
Pyramid High Security Fixed Core	PHS	Add \$135.00 per cylinder
Pyramid High Security LFIC	PCHS	Add \$241.00 per cylinder
Pyramid LFIC with Temporary Construction Core ³	CTP	Add \$112.00 per cylinder
Pyramid LFIC with Temporary Disposable Core ³	CTPD	No Charge
Pyramid LFIC Less Core	CLP	No Charge
Other		
Master Ring ²	MR	Add \$92.00 per cylinder
Flex Head Cylinder, 6-pin (sectional trim)	FX6	Add \$116.00 per cylinder
Flex Head Cylinder, 7-pin (sectional trim)	FX7	Add \$118.00 per cylinder
Flex Head Master Ring (sectional trim)	FXM	Add \$188.00 per cylinder
Plug only to show, 6-pin (concealed shell) (available for M and R escutcheons and single cylinder functions only)	P06	Add \$130.00 per lockset
Plug only to show, 7-pin (concealed shell) (available for M and R escutcheons and single cylinder functions only)	P07	Add \$132.00 per lockset

Notes:

1. CHS ordered with CT6 option no charge.
3. Refer to Key construction core program, pg. 28 for example of CTP option pricing.
4. For existing systems only.

Continued on next page

MP6600 Series Multi-Point Locks

USA & Canada Prices Effective March 3, 2025

Cylinder Options (continued) & Keying Options**

Description	Specify Quick Code		Add or Deduct	
Keying and Keys				
0-bitted with 2 Blank Keys	(standard)		No Charge	
Keyed Random	KR			
Construction Master Keyed ²	CMK			
More than 2 Keys	KY# (e.g., KY6)		See page 29 - Cut Keys Section	
Master Keying				
Master keyed (all cylinders except CR8000, CR8020, CR8027, CR8200, CR8500, CR8600, CR8700)	MK		Add \$16.00 per cylinder	
Master keyed Pyramid (except CR8020, CR8027 LFIC cores)	MK			
Master keyed Security (including LFIC cylinder and core)	MK			
Master keyed Access 3 (except CR8500, CR8600, CR8700 LFIC cores)	MK			
Master keyed (CR8000, CR8020, CR8027, CR8200, CR8500, CR8600, CR8700)	MK-IC		No Charge	
Master keyed to customer bittings or sample key	MK-CB		Add \$16.00 per cylinder	
Visual Cylinder/Key Control (VKC)	Cylinders		Keys	
	Stamping	List Price	Stamping	List Price
VKC0 – No stamping except keyway designation (keys will be tagged)	No Stamping	No Charge	No Stamping	\$5/Cyl
VKC1 – Keys only	N/A	N/A	Keyset	No Charge
VKC2 – Cylinder and keys*	Keyset	\$4/Cyl	Keyset	No Charge
VKC3 – Cylinder*	Keyset	\$4/Cyl	Bittings	No Charge
All VKC, VDC, or VAC stamping codes that use an alternate symbol	Alternate Stamping	\$4/Cyl	Alternate Stamping	\$4/Cyl
Concealed Cylinder/Visual Key Control (CKC)	Cylinders		Keys	
	Stamping	List Price	Stamping	List Price
CKC2 – Cylinder and Keys*	Keyset	\$4/Cyl	Keyset	No Charge
CKC3 – Cylinders only*	Keyset	\$4/Cyl	Bittings	No Charge
All CKC, CDC, or CAC stamping codes that use an alternate symbol	Alternate Stamping	\$4/Cyl	Alternate Stamping	\$4/Cyl

*Cylinder face stamping not available for Access 3, Pyramid, or Security products

Notes:

1. CMK Construction master keying charge is in addition to master keying charge.
2. CMK Construction master keying is not available in interchangeable core, Access 3, Pyramid, or Security series.
3. Pyramid series is not available keyed random.
4. Security series is not available 0-bitted.

**Double cylinder keying: unless otherwise specified, both cylinders of 32, 62, 72 and 82 functions will be keyed alike. The inside cylinder of 52 function will be keyed to the master key(s) only, while the outside cylinder will include the change key. If different keying is required, specify outside cylinder first, then inside cylinder. For key bows other than 10 and 90, specify 'KB' + bow number as Quick Code, e.g. KB12.

Strike Options*

Lip Length	ANSI Straight Lip - Specify Quick Code	ANSI Curved Lip - Specify Quick Code	Add or Deduct
7/8"	SS078	N/A	No Charge

* If door thickness is standard or has been specified and no special door or frame condition exist, then only the first two characters of the optional strike Quick Code must be specified (e.g. "SA").

The correct lip length will be determined by our order entry system based on the standard or specified door thickness.

MP6600 Series Multi-Point Locks



USA & Canada Prices Effective March 3, 2025

Door Thickness with Locksets Mortised on Center

Door Thickness	Sectional Rose Trim Specify Quick Code	Escutcheon ^{1,2} Trim Specify Quick Code	Add or Deduct
1-3/4" (standard)	—	—	No Charge

Options

Description	Specify Quick Code	Add or Deduct
Split designs and split finishes	Outside Trim x Inside Trim	Higher set price prevails
Spanner head screws	M02	Add \$30.00 per lockset
Torx® head screws (n/a with N escutcheon)	M04	Add \$36.00 per lockset
Single Occupancy Indicator - Secure/Unsecure (Outside)	M19S*	Add \$185.00 per lockset
Single Occupancy Indicator - Vacant/Occupied (Outside)	M19V*	Add \$185.00 per lockset
Double Occupancy Indicator - Secure/Unsecure (Outside) Secure/Unsecure (Inside)	M19SN*	Add \$370.00 per lockset
Double Indicator Vacant/Occupied (Outside) Secure/Unsecure (Inside)	M19VN*	Add \$370.00 per lockset
Knurling outside and inside	M20**	Add \$212.00 per lockset
Knurling outside only	M21**	Add \$106.00 per lockset
Knurling inside only	M22**	Add \$106.00 per lockset
Abrasive coat outside and inside	M23 ¹	Add \$134.00 per lockset
Abrasive coat inside only	M24 ¹	Add \$67.00 per lockset
Abrasive coat outside only	M25 ¹	Add \$67.00 per lockset

** All levers provided in a powder coat finish will be supplied with an abrasive coating.

Thumbturn Options

Specify door thickness	Specify Quick Code	Add or Deduct
Ergonomic	M34 ²	Add \$22.00 per TT
Decorative	MT1	No Charge
Decorative square	MT2	No Charge
Decorative cylinder	MT3	No Charge



MT1



MT2



MT3

Notes:

1. Not available with Vineyard™ or Muséo® levers.
2. M34 is not available with M19N, M19VN or M19SN.

Note: Thumbturn backplate will match shape of rose chosen (i.e. round or square)

Strike Options

Part Number	Description
726F577	Top Strike Pack
726F587	Bottom Strike Pack
726F607	Center Strike Pack

Dogging Indicator Kit

AUX188 x FIN -Dogging Indicator kit if ordered separately.

Price
\$767.00

Note: Concealed vertical rods, top & bottom latches, and the lockbody cassette will be factory installed. All other hardware components are shipped directly to the customer and must be installed by a factory trained installer. Invoices for the door will be separate from the hardware invoice. The hardware invoice will include the concealed vertical assembly and the trim components.

FE6600 Series

Series Multi-Point Locks



USA & Canada Prices Effective March 3, 2025

Door	1-3/4" thick door only - FE6600 Series requires utilizing Ceco Door StormPro 361 and Curries StormPro 361 doors and frames. McKINNEY StormPro hinges are required when used as a certified tornado solution
Mounting	Supplied fasteners are for metal doors with throughbolts for trim
Hand	Handed; specify RHR, LHR, RH or LH
Lockbody	Unique mortise lockbody assembly used for a variety of applications
Top Bolt	Adjustable stainless steel 3/4" square bolt with 11/16" engagement; 5/16" steel reinforcement plate
Bottom Bolt	Adjustable stainless steel 3/4" square bolt with 5/8" engagement; 1/4" steel reinforcement plate
Center Bolts	Latchbolt is stainless steel with 3/4" projection. One piece, anti-friction reversible catch. Deadbolt is one piece hardened stainless steel with 1" projection
Lock Front	1/8" steel mortise front reinforced with 13/64" thick lock edge stiffener
Center Bolt Strike	1/4" thick stainless steel
Backset	2-3/4" standard
Door Thickness	1-3/4" standard
Door Height	7'0" - 8'0"
Maximum Opening	Single door 4'0" x 8'0" and double doors 8'0" x 8'0".
UL Fire Listed	UL 3-hour fire rating
Trim	Multiple sectional and escutcheon mortise trim with Standard or Muséo levers
Cylinder	Multiple mortise cylinders

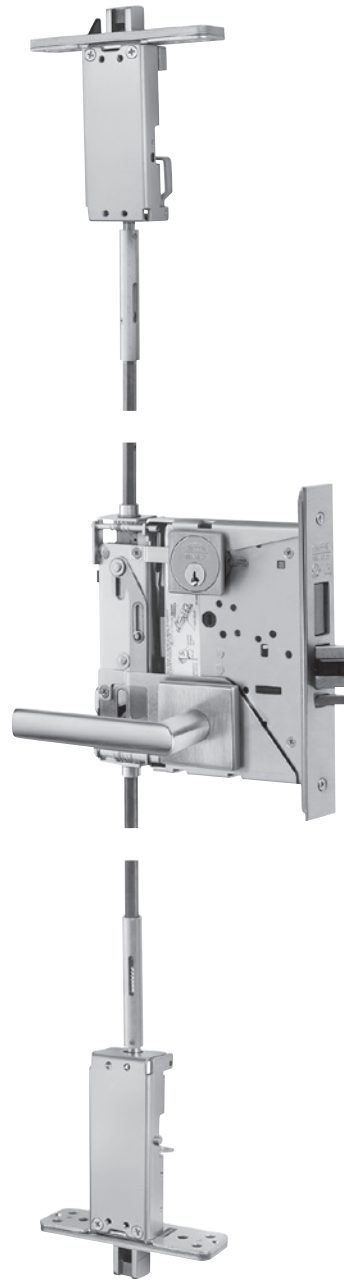

How to Order

Ordering Example

Quantity	Series/ Function	Trim	Finish	Hand
100	FE6618	ASM	626	RHR

Note: Concealed vertical rods, top & bottom latches, and the lockbody cassette will be factory installed. All other hardware components are shipped directly to the customer and must be installed by a factory trained installer. Invoices for the door will be separate from the hardware invoice. The hardware invoice will include the concealed vertical assembly and the trim components.

FE6600 Series Multi-Point Locks



USA & Canada Prices Effective March 3, 2025

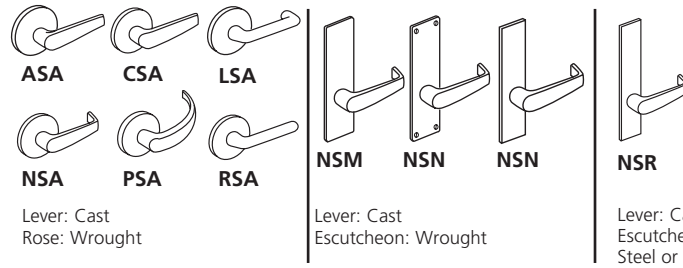

Available Functions	Description	Levers: AS, CS, ES, LS, NS, PS, RS Roses: A, G		Levers: AS, CS, ES, LS, NS, PS, RS Escutcheons: M, N, LW1		Levers: AS, CS, ES, LS, NS, PS, RS Escutcheons: RE1/RE2, RE3/RE4	
		613E, 626, BSP, WSP	605, 606, 611, 612, 613, 618, 619, 625, 629, 630, 722	613E, 626, BSP, WSP	605, 606, 611, 612, 613, 618, 619, 625, 629, 630, 722	613E, 626, BSP, WSP	605, 606, 611, 612, 613, 618, 619, 625, 629, 630, 722
Single Cylinder with Deadbolt							
FE6618 FE6665	Classroom Exit/Dormitory	\$5,499.00	\$5,523.00	\$5,519.00	\$5,543.00	\$5,573.00	\$5,597.00
Non-Keyed							
FE6680 FE6630	Inside Passage Privacy Bath	\$5,499.00	\$5,523.00	\$5,519.00	\$5,543.00	\$5,573.00	\$5,597.00
Double Cylinder with Deadbolt							
FE6662 FE6672 FE6673 FE6675	Classroom Security Intruder Deadbolt Classroom Security Intruder Aux. Deadbolt Classroom Security Intruder Deadlatch Security Deadbolt	\$5,499.00	\$5,523.00	\$5,519.00	\$5,543.00	\$5,573.00	\$5,597.00
EAC							
FE66609 x NAC SEC	No Key Override With Deadbolt Fail Secure 12V/24V	\$5,805.00	\$5,829.00	\$5,825.00	\$5,849.00	\$5,879.00	\$5,903.00
FE66608 x NAC SEC	Key Override With Deadbolt Fail Secure 12V/24V	\$6,007.00	\$6,031.00	\$6,027.00	\$6,051.00	\$6,081.00	\$6,105.00

FE6600 Series Multi-Point Locks

USA & Canada Prices Effective March 3, 2025

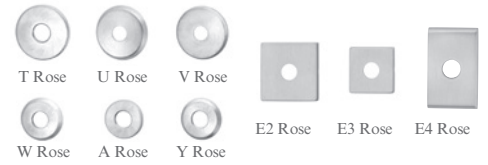
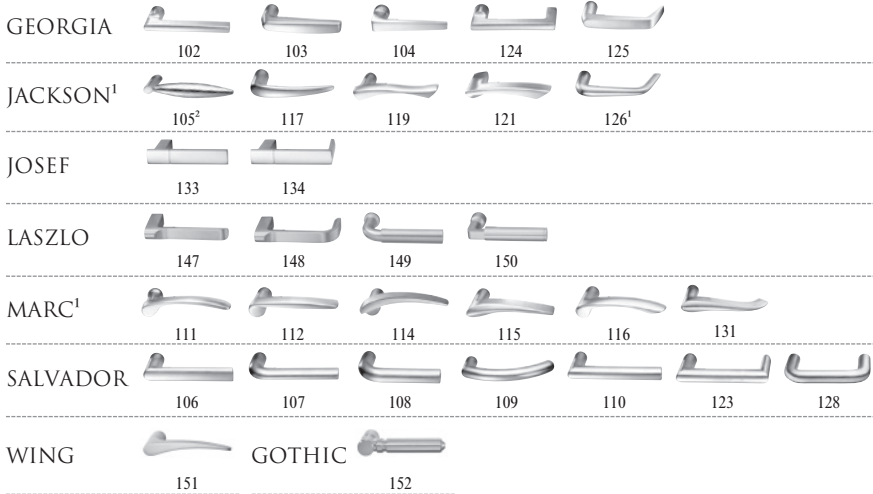

ESCUTCHEONS



THUMBTURNS³



1. Handed: specify hand when ordering
2. Contact factory for current lead time
3. Specify thumbturn as quick code. Thumbturn backplate will match shape of rose chosen (i.e. round or square). Not available with escutcheons.

*629 and *630 finish options are Not available for all Muséo levers. Please refer to page 22 for availability.

613E Dark Oxidized Satin Bronze - Equivalent	605 Bright Brass, Clear Coated	618 Bright Nickel Plated
626 Satin Chromium Plated	606 Satin Brass, Clear Coated	619 Satin Nickel Plated
BSP Black Suede Powder Coat	611 Bright Bronze, Clear Coated	625 Bright Chromium Plated
WSP White Suede Powder Coat	612 Satin Bronze, Clear Coated	629* Bright Stainless Steel
	613 Dark Oxidized Satin Bronze, Oil Rubbed	630* Satin Stainless Steel
	613L Dark Oxidized Satin Bronze, Clear Coated	722 Black Oxidized Bronze, Oil Rubbed

Functions	Description		
Single Cylinder with Deadbolt ESCUTCHEONS L, CE, RE1			
FE6618	Classroom	\$5,553.00	\$5,577.00
FE6665	Exit/Dormitory		
Non-Keyed ESCUTCHEONS L, CE, RE1			
FE6680	Inside Passage	\$5,553.00	\$5,577.00
FE6630	Privacy Bath		
Double Cylinder with Deadbolt ESCUTCHEONS L, CE, RE1			
FE6662	Classroom Security Intruder Deadbolt	\$5,553.00	\$5,577.00
FE6672	Classroom Security Intruder Aux. Deadbolt		
FE6673	Classroom Security Intruder Deadlatch		
FE6675	Security Deadbolt		
EAC ESCUTCHEONS L, CE, RE1			
FE66609 x NAC SEC	No Key Override With Deadbolt Fail Secure 12V/24V	\$5,859.00	\$5,883.00
FE66608 x NAC SEC	Key Override With Deadbolt Fail Secure 12V/24V	\$6,061.00	\$6,085.00

FE6600 Series Multi-Point Locks



USA & Canada Prices Effective March 3, 2025

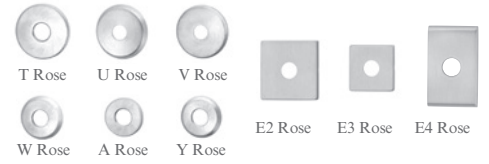
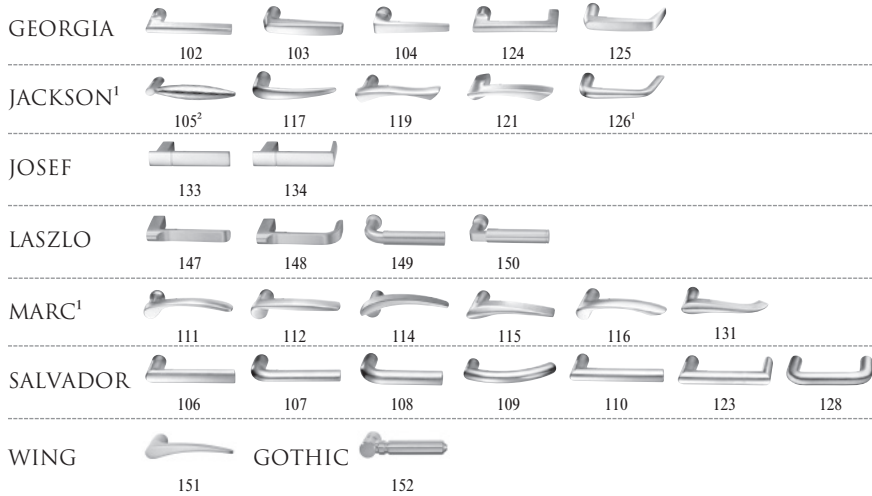

ESCUTCHEONS



THUMBTURNS³



1. Handed: specify hand when ordering
2. Contact factory for current lead time
3. Specify thumbturn as quick code. Thumbturn backplate will match shape of rose chosen (i.e. round or square). Not available with escutcheons.

*629 and *630 finish options are Not available for all Muséo levers. Please refer to page 22 for availability.

613E Dark Oxidized Satin Bronze - Equivalent	605 Bright Brass, Clear Coated	618 Bright Nickel Plated
626 Satin Chromium Plated	606 Satin Brass, Clear Coated	619 Satin Nickel Plated
BSP Black Suede Powder Coat	611 Bright Bronze, Clear Coated	625 Bright Chromium Plated
WSP White Suede Powder Coat	612 Satin Bronze, Clear Coated	629* Bright Stainless Steel
	613 Dark Oxidized Satin Bronze, Oil Rubbed	630* Satin Stainless Steel
	613L Dark Oxidized Satin Bronze, Clear Coated	722 Black Oxidized Bronze, Oil Rubbed

Functions	Description		
Single Cylinder with Deadbolt ROSES: A, T, U, V, W, Y, E2, E3, E4			
FE6618 FE6665	Classroom Exit/Dormitory	\$5,499.00	\$5,523.00
Non-Keyed ROSES: A, T, U, V, W, Y, E2, E3, E4			
FE6680 FE6630	Inside Passage Privacy Bath	\$5,499.00	\$5,523.00
Double Cylinder with Deadbolt ROSES: A, T, U, V, W, Y, E2, E3, E4			
FE6662 FE6672 FE6673 FE6675	Classroom Security Intruder Deadbolt Classroom Security Intruder Aux. Deadbolt Classroom Security Intruder Deadlatch Security Deadbolt	\$5,499.00	\$5,523.00
EAC ROSES: A, T, U, V, W, Y, E2, E3, E4			
FE66609 x NAC SEC	No Key Override With Deadbolt Fail Secure 12V/24V	\$5,805.00	\$5,829.00
FE66608 x NAC SEC	Key Override With Deadbolt Fail Secure 12V/24V	\$6,007.00	\$6,031.00

FE6600 Series Multi-Point Locks

USA & Canada Prices Effective March 3, 2025

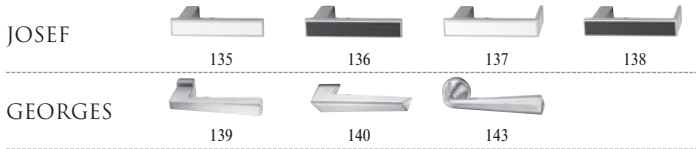

ROSES

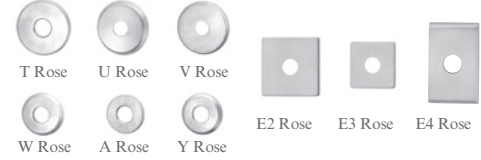

ESCUTCHEONS



THUMBTURNS³



1. Handed: specify hand when ordering
2. Contact factory for current lead time
3. Specify thumbturn as quick code. Thumbturn backplate will match shape of rose chosen (i.e. round or square). Not available with escutcheons.

613E	Dark Oxidized Satin Bronze - Equivalent	605	Bright Brass, Clear Coated	618	Bright Nickel Plated
626	Satin Chromium Plated	606	Satin Brass, Clear Coated	619	Satin Nickel Plated
BSP	Black Suede Powder Coat	611	Bright Bronze, Clear Coated	625	Bright Chromium Plated
WSP	White Suede Powder Coat	612	Satin Bronze, Clear Coated	629	Bright Stainless Steel
		613	Dark Oxidized Satin Bronze, Oil Rubbed	630	Satin Stainless Steel
		613L	Dark Oxidized Satin Bronze, Clear Coated	722	Black Oxidized Bronze, Oil Rubbed

Functions	Description		
Single Cylinder with Deadbolt ESCUTCHEONS L, CE, RE1			
FE6618	Classroom	\$5,679.00	\$5,703.00
FE6665	Exit/Dormitory		
Non-Keyed ESCUTCHEONS L, CE, RE1			
FE6680	Inside Passage	\$5,679.00	\$5,703.00
FE6630	Privacy Bath		
Double Cylinder with Deadbolt ESCUTCHEONS L, CE, RE1			
FE6662	Classroom Security Intruder Deadbolt	\$5,679.00	\$5,703.00
FE6672	Classroom Security Intruder Aux. Deadbolt		
FE6673	Classroom Security Intruder Deadlatch		
FE6675	Security Deadbolt		
EAC ESCUTCHEONS L, CE, RE1			
FE66609 x NAC SEC	No Key Override With Deadbolt Fail Secure 12V/24V	\$5,985.00	\$6,009.00
FE66608 x NAC SEC	Key Override With Deadbolt Fail Secure 12V/24V	\$6,187.00	\$6,211.00

FE6600 Series Multi-Point Locks



USA & Canada Prices Effective March 3, 2025

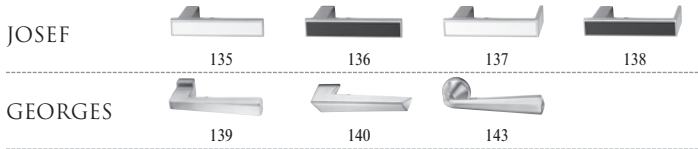

ROSES

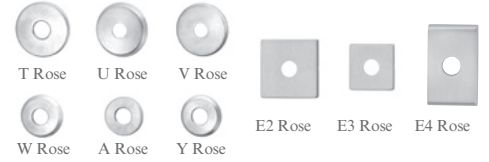

ESCUTCHEONS



THUMBTURNS³



1. Handed: specify hand when ordering
2. Contact factory for current lead time
3. Specify thumbturn as quick code. Thumbturn backplate will match shape of rose chosen (i.e. round or square). Not available with escutcheons.

613E	Dark Oxidized Satin Bronze - Equivalent	605	Bright Brass, Clear Coated	618	Bright Nickel Plated
626	Satin Chromium Plated	606	Satin Brass, Clear Coated	619	Satin Nickel Plated
BSP	Black Suede Powder Coat	611	Bright Bronze, Clear Coated	625	Bright Chromium Plated
WSP	White Suede Powder Coat	612	Satin Bronze, Clear Coated	629	Bright Stainless Steel
		613	Dark Oxidized Satin Bronze, Oil Rubbed	630	Satin Stainless Steel
		613L	Dark Oxidized Satin Bronze, Clear Coated	722	Black Oxidized Bronze, Oil Rubbed

Functions	Description		
Single Cylinder with Deadbolt ROSES: A, T, U, V, W, Y, E2, E3, E4			
FE6618 FE6665	Classroom Exit/Dormitory	\$5,625.00	\$5,649.00
Non-Keyed ROSES: A, T, U, V, W, Y, E2, E3, E4			
FE6680 FE6630	Inside Passage Privacy Bath	\$5,625.00	\$5,649.00
Double Cylinder with Deadbolt ROSES: A, T, U, V, W, Y, E2, E3, E4			
FE6662 FE6672 FE6673 FE6675	Classroom Security Intruder Deadbolt Classroom Security Intruder Aux. Deadbolt Classroom Security Intruder Deadlatch Security Deadbolt	\$5,625.00	\$5,649.00
EAC ROSES: A, T, U, V, W, Y, E2, E3, E4			
FE66609 x NAC SEC	No Key Override With Deadbolt Fail Secure 12V/24V	\$5,931.00	\$5,955.00
FE66608 x NAC SEC	Key Override With Deadbolt Fail Secure 12V/24V	\$6,133.00	\$6,157.00

FE6600 Series Multi-Point Locks

USA & Canada Prices Effective March 3, 2025



*613E, BSP, WSP finishes are not available with 21M levers.

ROSES



ESCUTCHEONS

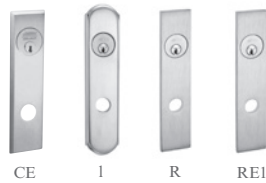

THUMBTURNS



Specify thumbturn as quick code. Thumbturn backplate will match shape of rose chosen (i.e. round or square)

613E Dark Oxidized Satin Bronze – Equivalent
629 Bright Stainless Steel
630 Satin Stainless Steel
BSP Black Suede Powder Coat
WSP White Suede Powder Coat

Functions	Description	
Single Cylinder with Deadbolt ESCUTCHEONS L, CE, RE1		
FE6618 FE6665	Classroom Exit/Dormitory	\$5,673.00
Non-Keyed ESCUTCHEONS L, CE, RE1		
FE6680 FE6630	Inside Passage Privacy Bath	\$5,673.00
Double Cylinder with Deadbolt ESCUTCHEONS L, CE, RE1		
FE6662 FE6672 FE6673 FE6675	Classroom Security Intruder Deadbolt Classroom Security Intruder Aux. Deadbolt Classroom Security Intruder Deadlatch Security Deadbolt	\$5,673.00
EAC ESCUTCHEONS L, CE, RE1		
FE66609 x NAC SEC	No Key Override With Deadbolt Fail Secure 12V/24V	\$5,979.00
FE66608 x NAC SEC	Key Override With Deadbolt Fail Secure 12V/24V	\$6,181.00

FE6600 Series Multi-Point Locks

USA & Canada Prices Effective March 3, 2025



*613E, BSP, WSP finishes are not available with 21M levers.

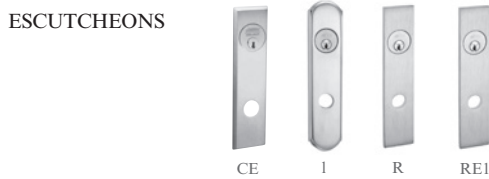
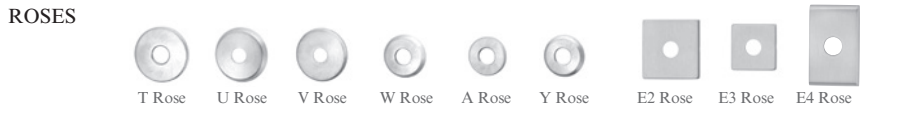

Specify thumbturn as quick code. Thumbturn backplate will match shape of rose chosen (i.e. round or square)

613E	Dark Oxidized Satin Bronze – Equivalent
629	Bright Stainless Steel
630	Satin Stainless Steel
BSP	Black Suede Powder Coat
WSP	White Suede Powder Coat

Functions	Description	
Single Cylinder with Deadbolt ROSES: A, T, U, V, W, Y, E2, E3, E4		
FE6618 FE6665	Classroom Exit/Dormitory	\$5,619.00
Non-Keyed ROSES: A, T, U, V, W, Y, E2, E3, E4		
FE6680 FE6630	Inside Passage Privacy Bath	\$5,619.00
Double Cylinder with Deadbolt ROSES: A, T, U, V, W, Y, E2, E3, E4		
FE6662 FE6672 FE6673 FE6675	Classroom Security Intruder Deadbolt Classroom Security Intruder Aux. Deadbolt Classroom Security Intruder Deadlatch Security Deadbolt	\$5,619.00
EAC ROSES: A, T, U, V, W, Y, E2, E3, E4		
FE66609 x NAC SEC	No Key Override With Deadbolt Fail Secure 12V/24V	\$5,925.00
FE66608 x NAC SEC	Key Override With Deadbolt Fail Secure 12V/24V	\$6,127.00

FE6600 Series Multi-Point Locks

USA & Canada Prices Effective March 3, 2025

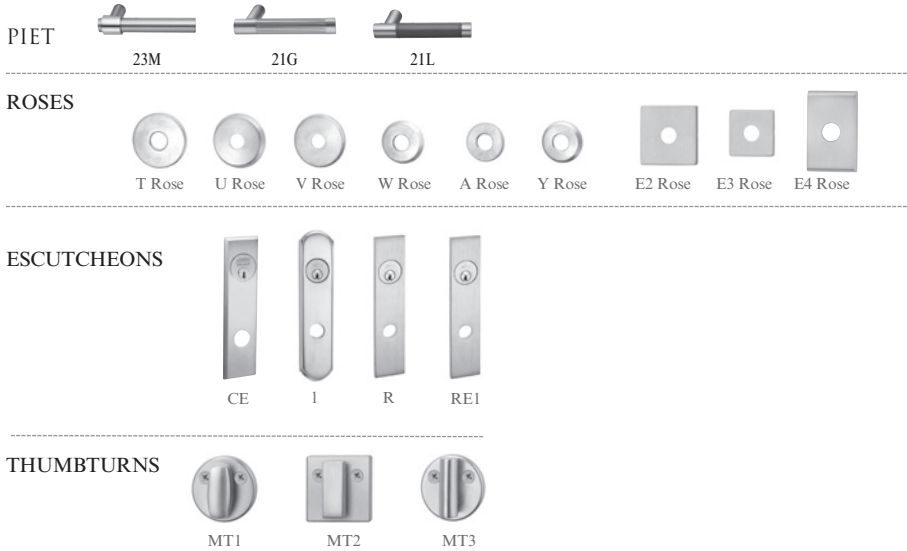

Specify thumbturn as quick code. Thumbturn backplate will match shape of rose chosen (i.e. round or square)

613E	Dark Oxidized Satin Bronze – Equivalent
629	Bright Stainless Steel
630	Satin Stainless Steel
BSP	Black Suede Powder Coat
WSP	White Suede Powder Coat

Functions	Description	
Single Cylinder with Deadbolt ESCUTCHEONS L, CE, RE1		
FE6618 FE6665	Classroom Exit/Dormitory	\$5,703.00
Non-Keyed ESCUTCHEONS L, CE, RE1		
FE6680 FE6630	Inside Passage Privacy Bath	\$5,703.00
Double Cylinder with Deadbolt ESCUTCHEONS L, CE, RE1		
FE6662 FE6672 FE6673 FE6675	Classroom Security Intruder Deadbolt Classroom Security Intruder Aux. Deadbolt Classroom Security Intruder Deadlatch Security Deadbolt	\$5,703.00
EAC ESCUTCHEONS L, CE, RE1		
FE66609 x NAC SEC	No Key Override With Deadbolt Fail Secure 12V/24V	\$6,009.00
FE66608 x NAC SEC	Key Override With Deadbolt Fail Secure 12V/24V	\$6,211.00

FE6600 Series Multi-Point Locks

USA & Canada Prices Effective March 3, 2025

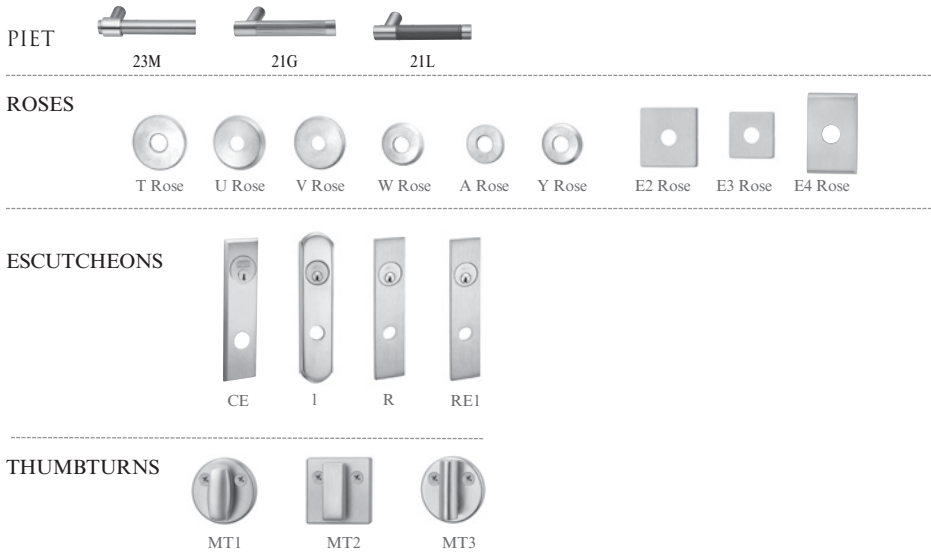

Specify thumbturn as quick code. Thumbturn backplate will match shape of rose chosen (i.e. round or square)

613E	Dark Oxidized Satin Bronze – Equivalent
629	Bright Stainless Steel
630	Satin Stainless Steel
BSP	Black Suede Powder Coat
WSP	White Suede Powder Coat

Functions	Description	
Single Cylinder with Deadbolt ROSES: A, T, U, V, W, Y, E2, E3, E4		
FE6618 FE6665	Classroom Exit/Dormitory	\$5,649.00
Non-Keyed ROSES: A, T, U, V, W, Y, E2, E3, E4		
FE6680 FE6630	Inside Passage Privacy Bath	\$5,649.00
Double Cylinder with Deadbolt ROSES: A, T, U, V, W, Y, E2, E3, E4		
FE6662 FE6672 FE6673 FE6675	Classroom Security Intruder Deadbolt Classroom Security Intruder Aux. Deadbolt Classroom Security Intruder Deadlatch Security Deadbolt	\$5,649.00
ROSES: A, T, U, V, W, Y, E2, E3, E4		
FE66609 x NAC SEC	No Key Override With Deadbolt Fail Secure 12V/24V	\$5,955.00
FE66608 x NAC SEC	Key Override With Deadbolt Fail Secure 12V/24V	\$6,157.00

FE6600 Series Multi-Point Locks



USA & Canada Prices Effective March 3, 2025

Cylinder Options		
Description	Specify Quick Code	Add or Deduct
Conventional 6-pin	(standard)	No Charge
Conventional 7-pin	7P	Add \$2.00 per cylinder
Less Standard Cylinder	LC	Deduct \$130.00 per cylinder
Less Concealed Shell Cylinder	PO-LC	Add \$5.00 per lockset
LFIC		
LFIC 6-pin	C6	Add \$112.00 per cylinder
LFIC 6-pin Less Core	CL6	No Charge
LFIC 6-pin with Temporary Construction Core (Red)	CT6R	Add \$112.00 per cylinder
LFIC 6-pin with Temporary Construction Core (Blue)	CT6B	Add \$112.00 per cylinder
LFIC 6-pin with Temporary Construction Core (Green)	CT6G	Add \$112.00 per cylinder
LFIC 6-pin with Temporary Disposable Core	CT6D	No Charge
LFIC 7-pin	C7	Add \$114.00 per cylinder
LFIC 7-pin Less Core	CL7	Add \$2.00 per cylinder
LFIC 7-pin with Temporary Construction Core (Red)	CT7R	Add \$114.00 per cylinder
LFIC 7-pin with Temporary Construction Core (Blue)	CT7B	Add \$114.00 per cylinder
LFIC 7-pin with Temporary Construction Core (Green)	CT7G	Add \$114.00 per cylinder
LFIC 7-pin with Temporary Disposable Core	CT7D	Add \$2.00 per cylinder
SFIC		
SFIC 6-pin	C6S	Add \$101.00 per cylinder
SFIC 6-pin with Temporary Construction Core (Blue)	CT6SB	Add \$101.00 per cylinder
SFIC 6-pin with SFIC disposable temporary core	CT6SD	No Charge
SFIC 6-pin with Less Core	CLS6	No Charge
SFIC 7-pin	C7S	Add \$101.00 per cylinder
SFIC 7-pin with Temporary Construction Core (Blue)	CT7SB	Add \$101.00 per cylinder
SFIC 7-pin with SFIC disposable temporary core	CT7SD	No Charge
SFIC 7-pin with Less Core	CLS7	No Charge
Security		
Security ⁴	HS	Add \$171.00 per cylinder
Security LFIC ^{1,4}	CHS	Add \$279.00 per cylinder
Access 3		
Access 3 Patented	AP	No Charge
Access 3 Security	AS	Add \$84.00 per cylinder
Access 3 High Security, UL 437	AHS	Add \$120.00 per cylinder
Access 3 LFIC Patented	ACP	Add \$112.00 per cylinder
Access 3 LFIC Security	ACS	Add \$196.00 per cylinder
Access 3 LFIC High Security, UL 437	ACHS	Add \$232.00 per cylinder
Pyramid		
Pyramid Security Fixed Core	PS	Add \$90.00 per cylinder
Pyramid Security LFIC	PCS	Add \$196.00 per cylinder
Pyramid High Security Fixed Core	PHS	Add \$135.00 per cylinder
Pyramid High Security LFIC	PCHS	Add \$241.00 per cylinder
Pyramid LFIC with Temporary Construction Core ³	CTP	Add \$112.00 per cylinder
Pyramid LFIC with Temporary Disposable Core ³	CTPD	No Charge
Pyramid LFIC Less Core	CLP	No Charge
Other		
Master Ring ²	MR	Add \$92.00 per cylinder
Flex Head Cylinder, 6-pin (sectional trim)	FX6	Add \$116.00 per cylinder
Flex Head Cylinder, 7-pin (sectional trim)	FX7	Add \$118.00 per cylinder
Flex Head Master Ring (sectional trim)	FXM	Add \$188.00 per cylinder
Plug only to show, 6-pin (concealed shell) (available for M and R escutcheons and single cylinder functions only)	P06	Add \$130.00 per lockset
Plug only to show, 7-pin (concealed shell) (available for M and R escutcheons and single cylinder functions only)	P07	Add \$132.00 per lockset

Notes:

1. CHS ordered with CT6 option no charge.
3. Refer to Key construction core program, pg. 28 for example of CTP option pricing.
4. For existing systems only.

Continued on next page

FE6600 Series Multi-Point Locks



USA & Canada Prices Effective March 3, 2025

Cylinder Options (continued) & Keying Options*				
Description	Specify Quick Code		Add or Deduct	
Keying and Keys				
0-bitted with 2 Blank Keys	(standard)		No Charge	
Keyed Random	KR			
Construction Master Keyed ²	CMK		Add \$16.00 per cylinder	
More than 2 Keys	KY# (e.g., KY6)		See page 29 - Cut Keys Section	
Master Keying				
Master keyed (all cylinders except CR8000, CR8020, CR8027, CR8200, CR8500, CR8600, CR8700)	MK		Add \$16.00 per cylinder	
Master keyed Pyramid (except CR8020, CR8027 LFIC cores)	MK			
Master keyed Security (including LFIC cylinder and core)	MK			
Master keyed Access 3 (except CR8500, CR8600, CR8700 LFIC cores)	MK			
Master keyed (CR8000, CR8020, CR8027, CR8200, CR8500, CR8600, CR8700)	MK-IC		No Charge	
Master keyed to customer bittings or sample key	MK-CB		Add \$16.00 per cylinder	
Visual Cylinder/Key Control (VKC)	Cylinders		Keys	
	Stamping	List Price	Stamping	List Price
VKC0 – No stamping except keyway designation (keys will be tagged)	No Stamping	No Charge	No Stamping	\$5/Cyl
VKC1 – Keys only	N/A	N/A	Keyset	No Charge
VKC2 – Cylinder and keys*	Keyset	\$4/Cyl	Keyset	No Charge
VKC3 – Cylinder*	Keyset	\$4/Cyl	Bittings	No Charge
All VKC, VDC, or VAC stamping codes that use an alternate symbol	Alternate Stamping	\$4/Cyl	Alternate Stamping	\$4/Cyl
Concealed Cylinder/Visual Key Control (CKC)	Cylinders		Keys	
	Stamping	List Price	Stamping	List Price
CKC2 – Cylinder and Keys*	Keyset	\$4/Cyl	Keyset	No Charge
CKC3 – Cylinders only*	Keyset	\$4/Cyl	Bittings	No Charge
All CKC, CDC, or CAC stamping codes that use an alternate symbol	Alternate Stamping	\$4/Cyl	Alternate Stamping	\$4/Cyl

*Cylinder face stamping not available for Access 3, Pyramid, or Security products

Notes:

1. CMK Construction master keying charge is in addition to master keying charge.
2. CMK Construction master keying is not available in interchangeable core, Access 3, Pyramid, or Security series.
3. Pyramid series is not available keyed random.
4. Security series is not available 0-bitted.

Strike Options*

Lip Length	ANSI Straight Lip - Specify Quick Code	ANSI Curved Lip - Specify Quick Code	Add or Deduct
7/8"	SS078	N/A	No Charge

* If door thickness is standard or has been specified and no special door or frame condition exist, then only the first two characters of the optional strike Quick Code must be specified (e.g. "SA").

The correct lip length will be determined by our order entry system based on the standard or specified door thickness.

**FE6600 Series
Multi-Point Locks**

USA & Canada Prices Effective March 3, 2025

Door Thickness with Locksets Mortised on Center

Door Thickness	Sectional Rose Trim Specify Quick Code	Escutcheon ^{1,2} Trim Specify Quick Code	Add or Deduct
1-3/4" (standard)	—	—	No Charge

Options

Description	Specify Quick Code	Add or Deduct
Split designs and split finishes	Outside Trim x Inside Trim	Higher set price prevails
Spanner head screws	M02	Add \$30.00 per lockset
Torx® head screws (n/a with N escutcheon)	M04	Add \$36.00 per lockset
Single Occupancy Indicator - Secure/Unsecure (Outside)	M19S*	Add \$185.00 per lockset
Single Occupancy Indicator - Vacant/Occupied (Outside)	M19V*	Add \$185.00 per lockset
Double Occupancy Indicator - Secure/Unsecure (Outside) Secure/Unsecure (Inside)	M19SN*	Add \$370.00 per lockset
Double Indicator Vacant/Occupied (Outside) Secure/Unsecure (Inside)	M19VN*	Add \$370.00 per lockset
Knurling outside and inside	M20**	Add \$212.00 per lockset
Knurling outside only	M21**	Add \$106.00 per lockset
Knurling inside only	M22**	Add \$106.00 per lockset
Abrasive coat outside and inside	M23 ¹	Add \$134.00 per lockset
Abrasive coat inside only	M24 ¹	Add \$67.00 per lockset
Abrasive coat outside only	M25 ¹	Add \$67.00 per lockset

** All levers provided in a powder coat finish will be supplied with an abrasive coating.

Thumbturn Options

Specify door thickness	Specify Quick Code	Add or Deduct
Ergonomic	M34 ²	Add \$22.00 per TT
Decorative	MT1	No Charge
Decorative square	MT2	No Charge
Decorative cylinder	MT3	No Charge



MT1



MT2



MT3

Notes:

1. Not available with Vineyard™ or Muséo® levers.
2. M34 is not available with M19N, M19VN or M19SN.

Note: Thumbturn backplate will match shape of rose chosen (i.e. round or square)

Strike Options

Part Number	Description
726F577	Top Strike Pack
726F587	Bottom Strike Pack
726F607	Center Strike Pack

Dogging Indicator Kit

AUX188 x FIN -Dogging Indicator kit if ordered separately.

Price
\$767.00

BL6600 Series

Series Multi-Point Locks

USA & Canada Prices Effective March 3, 2025

Door	1-3/4" thick door only – BL6600 Series requires utilizing Ceco Door and Curries Multi-Solution Opening doors and frames. McKINNEY® StormPro® hinges
Mounting	Supplied fasteners are for metal doors with thru-bolts for trim
Hand	Handed; specify RHR, LHR, RH or LH
Lockbody	Unique mortise lockbody assembly used specifically for blast applications
Top Bolt	Adjustable stainless steel 3/4" square bolt with 11/16" engagement; 5/16" steel reinforcement plate
Bottom Bolt	Adjustable stainless steel 3/4" square bolt with 5/8" engagement; 1/4" steel reinforcement plate
Center Bolts	Latchbolt is stainless steel with 3/4" projection. One piece, anti-friction reversible catch. Deadbolt is one piece hardened stainless steel with 1" projection
Lock Front	1/8" steel mortise front reinforced with 13/64" thick lock edge stiffener
Center Bolt Strike	1/4" thick stainless steel
Backset	Lever: 2-3/4" standard; Rods: 5-1/4"
Door Thickness	1-3/4" standard
Maximum Opening	Single door 2'8" x 6'8" up to 4'0" x 8'0" (only available as single door)
UL Fire Listed	UL 3-hour fire rating
Trim	Multiple sectional and escutcheon mortise trim with Standard or Muséo levers
Cylinder	Multiple mortise cylinders

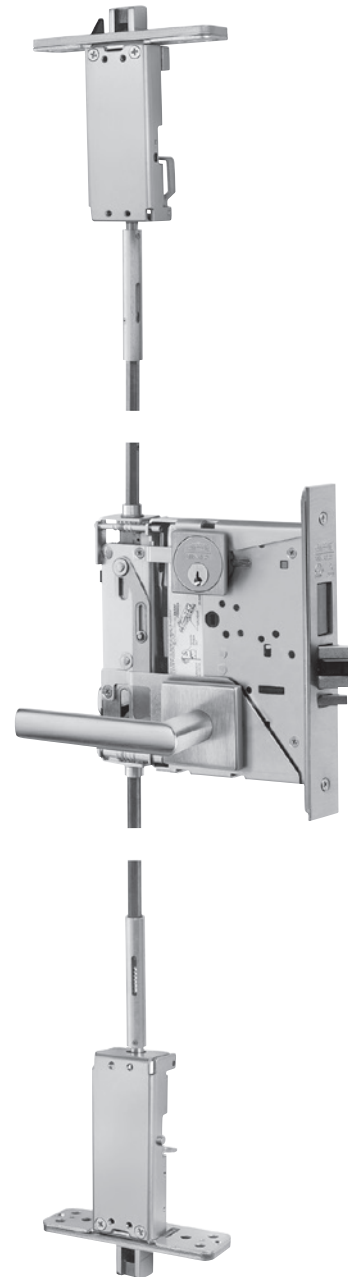

How to Order

Ordering Example

Quantity	Series/ Function	Trim	Finish	Hand
100	BL6618	ASM	626	RHR

Note: Concealed vertical rods, top & bottom latches, and the lockbody cassette will be factory installed. All other hardware components are shipped directly to the customer and must be installed by a factory trained installer. Invoices for the door will be separate from the hardware invoice. The hardware invoice will include the concealed vertical assembly and the trim components.

BL6600 Series Multi-Point Locks



USA & Canada Prices Effective March 3, 2025

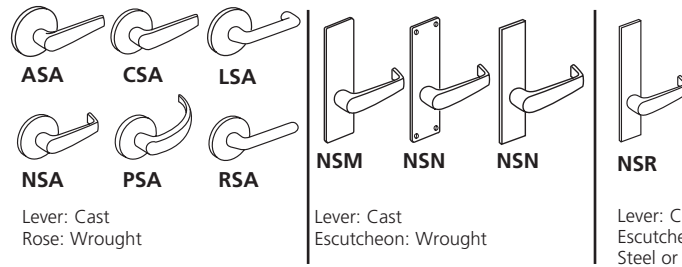

Available Functions	Description	Levers: AS, CS, ES, LS, NS, PS, RS Roses: A, G		Levers: AS, CS, ES, LS, NS, PS, RS Escutcheons: M, N, LW1		Levers: AS, CS, ES, LS, NS, PS, RS Escutcheons: RE1/RE2, RE3/RE4	
		613E, 626, BSP, WSP	605, 606, 611, 612, 613, 618, 619, 625, 629, 630, 722	613E, 626, BSP, WSP	605, 606, 611, 612, 613, 618, 619, 625, 629, 630, 722	613E, 626, BSP, WSP	605, 606, 611, 612, 613, 618, 619, 625, 629, 630, 722
Single Cylinder with Deadbolt							
BL6618 BL6624 BL6665	Classroom Storeroom Exit/Dormitory	\$6,048.00	\$6,072.00	\$6,068.00	\$6,092.00	\$6,122.00	\$6,146.00
Non-Keyed							
BL6680 BL6630 BL6620	Inside Passage Privacy Bath Privacy Bedroom	\$6,048.00	\$6,072.00	\$6,068.00	\$6,092.00	\$6,122.00	\$6,146.00
Double Cylinder with Deadbolt							
BL6622 BL6662 BL6672 BL6673 BL6675	Store Door Classroom Security Intruder Deadbolt Classroom Security Intruder Aux. Deadbolt Classroom Security Intruder Deadlatch Security Deadbolt	\$6,048.00	\$6,072.00	\$6,068.00	\$6,092.00	\$6,122.00	\$6,146.00
EAC							
BL66609 x NAC SAF / SEC	No Key Override With Deadbolt Fail Safe/Secure 12V/24V	\$6,354.00	\$6,378.00	\$6,374.00	\$6,398.00	\$6,428.00	\$6,452.00
BL66608 x NAC SAF / SEC	Key Override With Deadbolt Fail Safe/Secure 12V/24V	\$6,556.00	\$6,580.00	\$6,576.00	\$6,600.00	\$6,630.00	\$6,654.00

BL6600 Series Multi-Point Locks



USA & Canada Prices Effective March 3, 2025

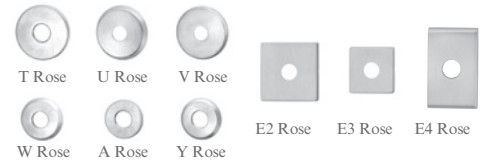
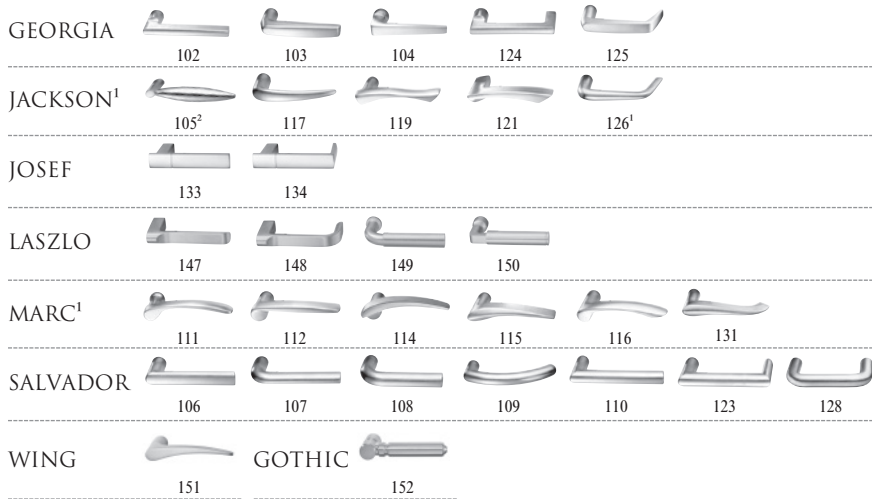

ESCUTCHEONS



THUMBTURNS³



1. Handed: specify hand when ordering
2. Contact factory for current lead time
3. Specify thumbturn as quick code. Thumbturn backplate will match shape of rose chosen (i.e. round or square). Not available with escutcheons.

*629 and *630 finish options are Not available for all Muséo levers. Please refer to page 22 for availability.

613E	Dark Oxidized Satin Bronze - Equivalent	605	Bright Brass, Clear Coated	618	Bright Nickel Plated
626	Satin Chromium Plated	606	Satin Brass, Clear Coated	619	Satin Nickel Plated
BSP	Black Suede Powder Coat	611	Bright Bronze, Clear Coated	625	Bright Chromium Plated
WSP	White Suede Powder Coat	612	Satin Bronze, Clear Coated	629*	Bright Stainless Steel
		613	Dark Oxidized Satin Bronze, Oil Rubbed	630*	Satin Stainless Steel
		613L	Dark Oxidized Satin Bronze, Clear Coated	722	Black Oxidized Bronze, Oil Rubbed

Functions	Description		
Single Cylinder with Deadbolt ESCUTCHEONS: L, CE, RE1			
BL6618 BL6624 BL6665	Classroom Storeroom Exit/Dormitory	\$6,102.00	\$6,126.00
Non-Keyed ESCUTCHEONS: L, CE, RE1			
BL6680 BL6630 BL6620	Inside Passage Privacy Bath Privacy Bedroom	\$6,102.00	\$6,126.00
Double Cylinder with Deadbolt ESCUTCHEONS: L, CE, RE1			
BL6622 BL6662 BL6672 BL6673 BL6675	Store Door Classroom Security Intruder Deadbolt Classroom Security Intruder Aux. Deadbolt Classroom Security Intruder Deadlatch Security Deadbolt	\$6,102.00	\$6,126.00
EAC ESCUTCHEONS: L, CE, RE1			
BL66609 x NAC SAF / SEC	No Key Override With Deadbolt Fail Safe/Secure 12V/24V	\$6,408.00	\$6,432.00
BL66608 x NAC SAF / SEC	Key Override With Deadbolt Fail Safe/Secure 12V/24V	\$6,610.00	\$6,634.00

BL6600 Series Multi-Point Locks

USA & Canada Prices Effective March 3, 2025

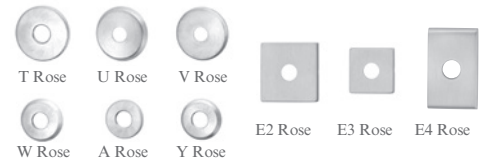
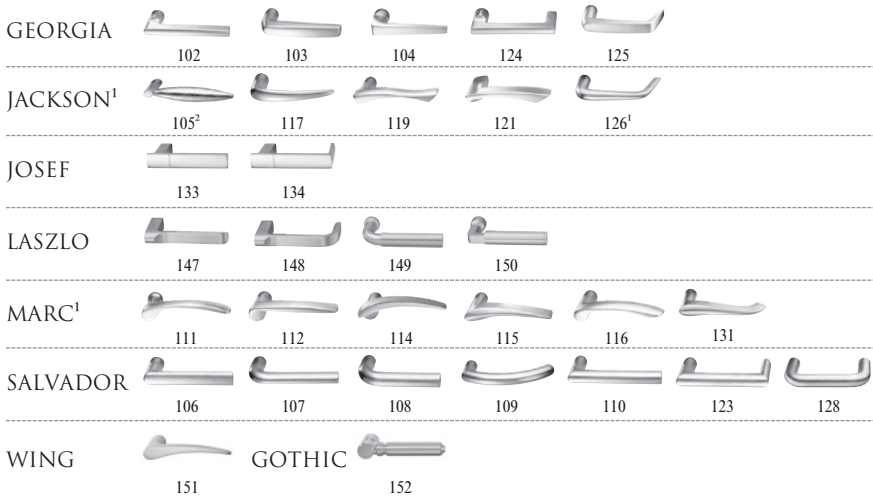

ESCUTCHEONS



THUMBTURNS³



1. Handed: specify hand when ordering
2. Contact factory for current lead time
3. Specify thumbturn as quick code. Thumbturn backplate will match shape of rose chosen (i.e. round or square). Not available with escutcheons.

*629 and *630 finish options are Not available for all Muséo levers. Please refer to page 22 for availability.

613E Dark Oxidized Satin Bronze - Equivalent	605 Bright Brass, Clear Coated	618 Bright Nickel Plated
626 Satin Chromium Plated	606 Satin Brass, Clear Coated	619 Satin Nickel Plated
BSP Black Suede Powder Coat	611 Bright Bronze, Clear Coated	625 Bright Chromium Plated
WSP White Suede Powder Coat	612 Satin Bronze, Clear Coated	629* Bright Stainless Steel
	613 Dark Oxidized Satin Bronze, Oil Rubbed	630* Satin Stainless Steel
	613L Dark Oxidized Satin Bronze, Clear Coated	722 Black Oxidized Bronze, Oil Rubbed

Functions	Description		
Single Cylinder with Deadbolt ROSES: A, T, U, V, W, Y, E2, E3, E4			
BL6618 BL6624 BL6665	Classroom Storeroom Exit/Dormitory	\$6,048.00	\$6,072.00
Non-Keyed ROSES: A, T, U, V, W, Y, E2, E3, E4			
BL6680 BL6630 BL6620	Inside Passage Privacy Bath Privacy Bedroom	\$6,048.00	\$6,072.00
Double Cylinder with Deadbolt ROSES: A, T, U, V, W, Y, E2, E3, E4			
BL6622 BL6662 BL6672 BL6673 BL6675	Store Door Classroom Security Intruder Deadbolt Classroom Security Intruder Aux. Deadbolt Classroom Security Intruder Deadlatch Security Deadbolt	\$6,048.00	\$6,072.00
EAC ROSES: A, T, U, V, W, Y, E2, E3, E4			
BL66609 x NAC SAF / SEC	No Key Override With Deadbolt Fail Safe/Secure 12V/24V	\$6,354.00	\$6,378.00
BL66608 x NAC SAF / SEC	Key Override With Deadbolt Fail Safe/Secure 12V/24V	\$6,556.00	\$6,580.00

BL6600 Series Multi-Point Locks



USA & Canada Prices Effective March 3, 2025

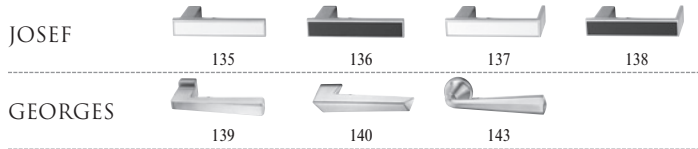

ROSES

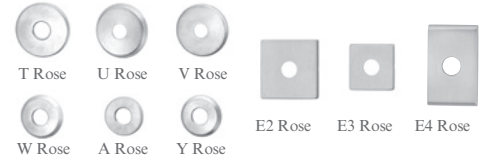

ESCUTCHEONS



THUMBTURNS³



1. Handed: specify hand when ordering
2. Contact factory for current lead time
3. Specify thumbturn as quick code. Thumbturn backplate will match shape of rose chosen (i.e. round or square). Not available with escutcheons.

613E	Dark Oxidized Satin Bronze	605	Bright Brass, Clear Coated	618	Bright Nickel Plated
626	Satin Chromium Plated	606	Satin Brass, Clear Coated	619	Satin Nickel Plated
BSP	Black Suede Powder Coat	611	Bright Bronze, Clear Coated	625	Bright Chromium Plated
WSP	White Suede Powder Coat	612	Satin Bronze, Clear Coated	629	Bright Stainless Steel
		613	Dark Oxidized Satin Bronze, Oil Rubbed	630	Satin Stainless Steel
		613L	Dark Oxidized Satin Bronze, Clear Coated	722	Black Oxidized Bronze, Oil Rubbed

Functions	Description		
Single Cylinder with Deadbolt ESCUTCHEONS: L, CE, RE1			
BL6618 BL6624 BL6665	Classroom Storeroom Exit/Dormitory	\$6,228.00	\$6,252.00
Non-Keyed ESCUTCHEONS: L, CE, RE1			
BL6680 BL6630 BL6620	Inside Passage Privacy Bath Privacy Bedroom	\$6,228.00	\$6,252.00
Double Cylinder with Deadbolt ESCUTCHEONS: L, CE, RE1			
BL6622 BL6662 BL6672 BL6673 BL6675	Store Door Classroom Security Intruder Deadbolt Classroom Security Intruder Aux. Deadbolt Classroom Security Intruder Deadlatch Security Deadbolt	\$6,228.00	\$6,252.00
EAC ESCUTCHEONS: L, CE, RE1			
BL66609 x NAC SAF / SEC	No Key Override With Deadbolt Fail Safe/Secure 12V/24V	\$6,534.00	\$6,558.00
BL66608 x NAC SAF / SEC	Key Override With Deadbolt Fail Safe/Secure 12V/24V	\$6,736.00	\$6,760.00

BL6600 Series Multi-Point Locks

USA & Canada Prices Effective March 3, 2025

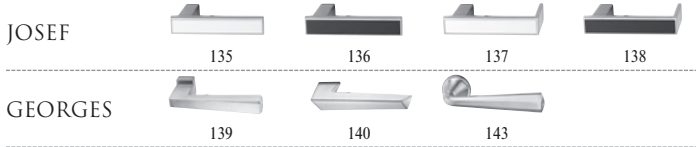

ROSES

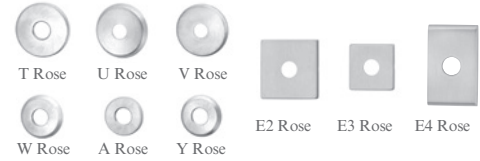

ESCUTCHEONS



THUMBTURNS³



1. Handed: specify hand when ordering
2. Contact factory for current lead time
3. Specify thumbturn as quick code. Thumbturn backplate will match shape of rose chosen (i.e. round or square). Not available with escutcheons.

613E	Dark Oxidized Satin Bronze	605	Bright Brass, Clear Coated	618	Bright Nickel Plated
626	Satin Chromium Plated	606	Satin Brass, Clear Coated	619	Satin Nickel Plated
BSP	Black Suede Powder Coat	611	Bright Bronze, Clear Coated	625	Bright Chromium Plated
WSP	White Suede Powder Coat	612	Satin Bronze, Clear Coated	629	Bright Stainless Steel
		613	Dark Oxidized Satin Bronze, Oil Rubbed	630	Satin Stainless Steel
		613L	Dark Oxidized Satin Bronze, Clear Coated	722	Black Oxidized Bronze, Oil Rubbed

Functions	Description		
Single Cylinder with Deadbolt ROSES: A, T, U, V, W, Y, E2, E3, E4			
BL6618 BL6624 BL6665	Classroom Storeroom Exit/Dormitory	\$6,174.00	\$6,198.00
Non-Keyed ROSES: A, T, U, V, W, Y, E2, E3, E4			
BL6680 BL6630 BL6620	Inside Passage Privacy Bath Privacy Bedroom	\$6,174.00	\$6,198.00
Double Cylinder with Deadbolt ROSES: A, T, U, V, W, Y, E2, E3, E4			
BL6622 BL6662 BL6672 BL6673 BL6675	Store Door Classroom Security Intruder Deadbolt Classroom Security Intruder Aux. Deadbolt Classroom Security Intruder Deadlatch Security Deadbolt	\$6,174.00	\$6,198.00
EAC ROSES: A, T, U, V, W, Y, E2, E3, E4			
BL66609 x NAC SAF / SEC	No Key Override With Deadbolt Fail Safe/Secure 12V/24V	\$6,480.00	\$6,504.00
BL66608 x NAC SAF / SEC	Key Override With Deadbolt Fail Safe/Secure 12V/24V	\$6,682.00	\$6,706.00

BL6600 Series Multi-Point Locks

USA & Canada Prices Effective March 3, 2025



*613E, BSP, WSP finishes are not available with 21M levers.



Specify thumbturn as quick code. Thumbturn backplate will match shape of rose chosen (i.e. round or square)

613E	Dark Oxidized Satin Bronze – Equivalent
629	Bright Stainless Steel
630	Satin Stainless Steel
BSP	Black Suede Powder Coat
WSP	White Suede Powder Coat

Functions	Description	
Single Cylinder with Deadbolt ESCUTCHEONS: L, CE, RE1		
BL6618 BL6624 BL6665	Classroom Storeroom Exit/Dormitory	\$6,222.00
Non-Keyed ESCUTCHEONS: L, CE, RE1		
BL6680 BL6630 BL6620	Inside Passage Privacy Bath Privacy Bedroom	\$6,222.00
Double Cylinder with Deadbolt ESCUTCHEONS: L, CE, RE1		
BL6622 BL6662 BL6672 BL6673 BL6675	Store Door Classroom Security Intruder Deadbolt Classroom Security Intruder Aux. Deadbolt Classroom Security Intruder Deadlatch Security Deadbolt	\$6,222.00
EAC ESCUTCHEONS: L, CE, RE1		
BL66609 x NAC SAF / SEC	No Key Override With Deadbolt Fail Safe/Secure 12V/24V	\$6,528.00
BL66608 x NAC SAF / SEC	Key Override With Deadbolt Fail Safe/Secure 12V/24V	\$6,730.00

BL6600 Series Multi-Point Locks

USA & Canada Prices Effective March 3, 2025



*613E, BSP, WSP finishes are not available with 21M levers.

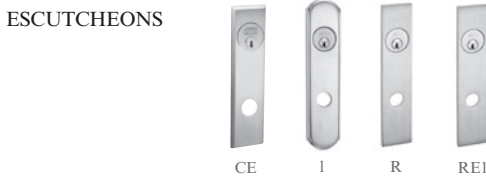

Specify thumbturn as quick code. Thumbturn backplate will match shape of rose chosen (i.e. round or square)

613E Dark Oxidized Satin Bronze – Equivalent
629 Bright Stainless Steel
630 Satin Stainless Steel
BSP Black Suede Powder Coat
WSP White Suede Powder Coat

Functions	Description	
Single Cylinder with Deadbolt ROSES: A, T, U, V, W, Y, E2, E3, E4		
BL6618 BL6624 BL6665	Classroom Storeroom Exit/Dormitory	\$6,168.00
Non-Keyed ROSES: A, T, U, V, W, Y, E2, E3, E4		
BL6680 BL6630 BL6620	Inside Passage Privacy Bath Privacy Bedroom	\$6,168.00
Double Cylinder with Deadbolt ROSES: A, T, U, V, W, Y, E2, E3, E4		
BL6622 BL6662 BL6672 BL6673 BL6675	Store Door Classroom Security Intruder Deadbolt Classroom Security Intruder Aux. Deadbolt Classroom Security Intruder Deadlatch Security Deadbolt	\$6,168.00
EAC ROSES: A, T, U, V, W, Y, E2, E3, E4		
BL66609 x NAC SAF / SEC	No Key Override With Deadbolt Fail Safe/Secure 12V/24V	\$6,474.00
BL66608 x NAC SAF / SEC	Key Override With Deadbolt Fail Safe/Secure 12V/24V	\$6,676.00

BL6600 Series Multi-Point Locks

USA & Canada Prices Effective March 3, 2025

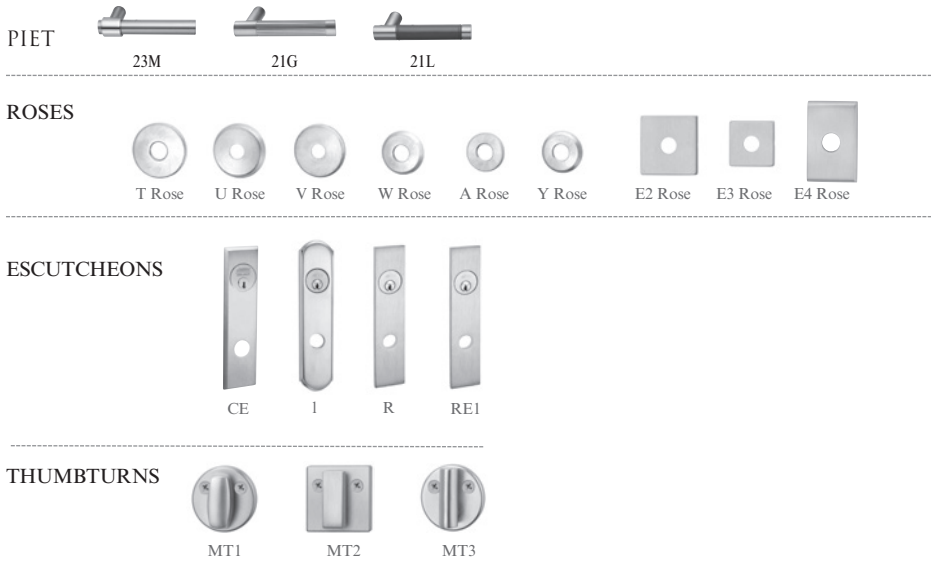

Specify thumbturn as quick code. Thumbturn backplate will match shape of rose chosen (i.e. round or square)

613E	Dark Oxidized Satin Bronze – Equivalent
629	Bright Stainless Steel
630	Satin Stainless Steel
BSP	Black Suede Powder Coat
WSP	White Suede Powder Coat

Functions	Description	
Single Cylinder with Deadbolt ESCUTCHEONS: L, CE, RE1		
BL6618 BL6624 BL6665	Classroom Storeroom Exit/Dormitory	\$6,252.00
Non-Keyed ESCUTCHEONS: L, CE, RE1		
BL6680 BL6630 BL6620	Inside Passage Privacy Bath Privacy Bedroom	\$6,252.00
Double Cylinder with Deadbolt ESCUTCHEONS: L, CE, RE1		
BL6622 BL6662 BL6672 BL6673 BL6675	Store Door Classroom Security Intruder Deadbolt Classroom Security Intruder Aux. Deadbolt Classroom Security Intruder Deadlatch Security Deadbolt	\$6,252.00
EAC ESCUTCHEONS: L, CE, RE1		
BL66609 x NAC SAF / SEC	No Key Override With Deadbolt Fail Safe/Secure 12V/24V	\$6,558.00
BL66608 x NAC SAF / SEC	Key Override With Deadbolt Fail Safe/Secure 12V/24V	\$6,760.00

BL6600 Series Multi-Point Locks

USA & Canada Prices Effective March 3, 2025

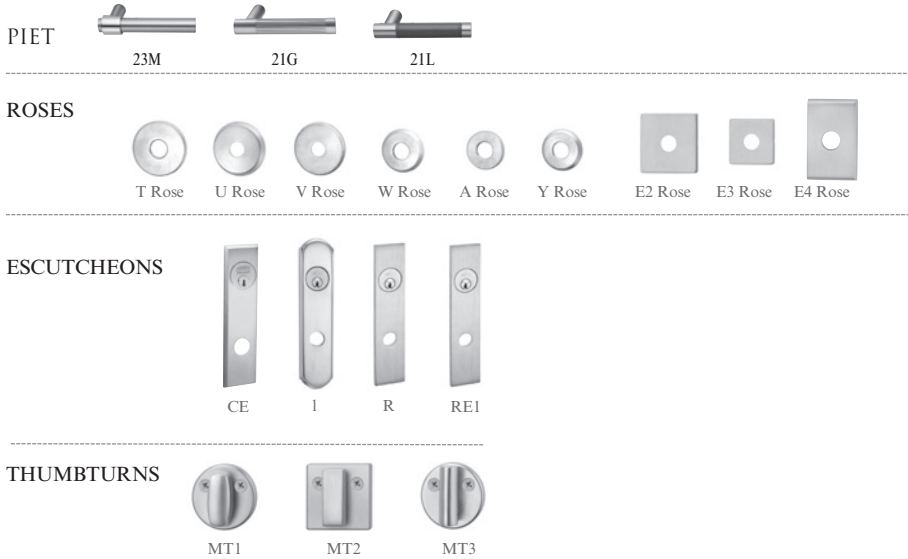

Specify thumbturn as quick code. Thumbturn backplate will match shape of rose chosen (i.e. round or square)

613E	Dark Oxidized Satin Bronze – Equivalent
629	Bright Stainless Steel
630	Satin Stainless Steel
BSP	Black Suede Powder Coat
WSP	White Suede Powder Coat

Functions	Description	
Single Cylinder with Deadbolt ROSES: A, T, U, V, W, Y, E2, E3, E4		
BL6618 BL6624 BL6665	Classroom Storeroom Exit/Dormitory	\$6,198.00
Non-Keyed ROSES: A, T, U, V, W, Y, E2, E3, E4		
BL6680 BL6630 BL6620	Inside Passage Privacy Bath Privacy Bedroom	\$6,198.00
Double Cylinder with Deadbolt ROSES: A, T, U, V, W, Y, E2, E3, E4		
BL6622 BL6662 BL6672 BL6673 BL6675	Store Door Classroom Security Intruder Deadbolt Classroom Security Intruder Aux. Deadbolt Classroom Security Intruder Deadlatch Security Deadbolt	\$6,198.00
EAC ROSES: A, T, U, V, W, Y, E2, E3, E4		
BL66609 x NAC SAF / SEC	No Key Override With Deadbolt Fail Safe/Secure 12V/24V	\$6,504.00
BL66608 x NAC SAF / SEC	Key Override With Deadbolt Fail Safe/Secure 12V/24V	\$6,706.00

BL6600 Series Multi-Point Locks



USA & Canada Prices Effective March 3, 2025

Cylinder Options		
Description	Specify Quick Code	Add or Deduct
Conventional 6-pin	(standard)	No Charge
Conventional 7-pin	7P	Add \$2.00 per cylinder
Less Standard Cylinder	LC	Deduct \$130.00 per cylinder
Less Concealed Shell Cylinder	PO-LC	Add \$5.00 per lockset
LFIC		
LFIC 6-pin	C6	Add \$112.00 per cylinder
LFIC 6-pin Less Core	CL6	No Charge
LFIC 6-pin with Temporary Construction Core (Red)	CT6R	Add \$112.00 per cylinder
LFIC 6-pin with Temporary Construction Core (Blue)	CT6B	Add \$112.00 per cylinder
LFIC 6-pin with Temporary Construction Core (Green)	CT6G	Add \$112.00 per cylinder
LFIC 6-pin with Temporary Disposable Core	CT6D	No Charge
LFIC 7-pin	C7	Add \$114.00 per cylinder
LFIC 7-pin Less Core	CL7	Add \$2.00 per cylinder
LFIC 7-pin with Temporary Construction Core (Red)	CT7R	Add \$114.00 per cylinder
LFIC 7-pin with Temporary Construction Core (Blue)	CT7B	Add \$114.00 per cylinder
LFIC 7-pin with Temporary Construction Core (Green)	CT7G	Add \$114.00 per cylinder
LFIC 7-pin with Temporary Disposable Core	CT7D	Add \$2.00 per cylinder
SFIC		
SFIC 6-pin	C6S	Add \$101.00 per cylinder
SFIC 6-pin with Temporary Construction Core (Blue)	CT6SB	Add \$101.00 per cylinder
SFIC 6-pin with SFIC disposable temporary core	CT6SD	No Charge
SFIC 6-pin with Less Core	CLS6	No Charge
SFIC 7-pin	C7S	Add \$101.00 per cylinder
SFIC 7-pin with Temporary Construction Core (Blue)	CT7SB	Add \$101.00 per cylinder
SFIC 7-pin with SFIC disposable temporary core	CT7SD	No Charge
SFIC 7-pin with Less Core	CLS7	No Charge
Security		
Security ⁴	HS	Add \$171.00 per cylinder
Security LFIC ^{1,4}	CHS	Add \$279.00 per cylinder
Access 3		
Access 3 Patented	AP	No Charge
Access 3 Security	AS	Add \$84.00 per cylinder
Access 3 High Security, UL 437	AHS	Add \$120.00 per cylinder
Access 3 LFIC Patented	ACP	Add \$112.00 per cylinder
Access 3 LFIC Security	ACS	Add \$196.00 per cylinder
Access 3 LFIC High Security, UL 437	ACHS	Add \$232.00 per cylinder
Pyramid		
Pyramid Security Fixed Core	PS	Add \$90.00 per cylinder
Pyramid Security LFIC	PCS	Add \$196.00 per cylinder
Pyramid High Security Fixed Core	PHS	Add \$135.00 per cylinder
Pyramid High Security LFIC	PCHS	Add \$241.00 per cylinder
Pyramid LFIC with Temporary Construction Core ³	CTP	Add \$112.00 per cylinder
Pyramid LFIC with Temporary Disposable Core ³	CTPD	No Charge
Pyramid LFIC Less Core	CLP	No Charge
Other		
Master Ring ²	MR	Add \$92.00 per cylinder
Flex Head Cylinder, 6-pin (sectional trim)	FX6	Add \$116.00 per cylinder
Flex Head Cylinder, 7-pin (sectional trim)	FX7	Add \$118.00 per cylinder
Flex Head Master Ring (sectional trim)	FXM	Add \$188.00 per cylinder
Plug only to show, 6-pin (concealed shell) (available for M and R escutcheons and single cylinder functions only)	P06	Add \$130.00 per lockset
Plug only to show, 7-pin (concealed shell) (available for M and R escutcheons and single cylinder functions only)	P07	Add \$132.00 per lockset

Notes:

1. CHS ordered with CT6 option no charge.
2. Refer to Key construction core program, pg. 28 for example of CTP option pricing.
3. For existing systems only.

Continued on next page

BL6600 Series Multi-Point Locks

USA & Canada Prices Effective March 3, 2025

Cylinder Options (continued) & Keying Options*

Description	Specify Quick Code		Add or Deduct	
Keying and Keys				
0-bitted with 2 Blank Keys	(standard)		No Charge	
Keyed Random	KR			
Construction Master Keyed ²	CMK			
More than 2 Keys	KY# (e.g., KY6)		See page 29 - Cut Keys Section	
Master Keying				
Master keyed (all cylinders except CR8000, CR8020, CR8027, CR8200, CR8500, CR8600, CR8700)	MK		Add \$16.00 per cylinder	
Master keyed Pyramid (except CR8020, CR8027 LFIC cores)	MK			
Master keyed Security (including LFIC cylinder and core)	MK			
Master keyed Access 3 (except CR8500, CR8600, CR8700 LFIC cores)	MK			
Master keyed (CR8000, CR8020, CR8027, CR8200, CR8500, CR8600, CR8700)	MK-IC		No Charge	
Master keyed to customer bittings or sample key	MK-CB		Add \$16.00 per cylinder	
Visual Cylinder/Key Control (VKC)	Cylinders		Keys	
	Stamping	List Price	Stamping	List Price
VKC0 – No stamping except keyway designation (keys will be tagged)	No Stamping	No Charge	No Stamping	\$5/Cyl
VKC1 – Keys only	N/A	N/A	Keyset	No Charge
VKC2 – Cylinder and keys*	Keyset	\$4/Cyl	Keyset	No Charge
VKC3 – Cylinder*	Keyset	\$4/Cyl	Bittings	No Charge
All VKC, VDC, or VAC stamping codes that use an alternate symbol	Alternate Stamping	\$4/Cyl	Alternate Stamping	\$4/Cyl
Concealed Cylinder/Visual Key Control (CKC)	Cylinders		Keys	
	Stamping	List Price	Stamping	List Price
CKC2 – Cylinder and Keys*	Keyset	\$4/Cyl	Keyset	No Charge
CKC3 – Cylinders only*	Keyset	\$4/Cyl	Bittings	No Charge
All CKC, CDC, or CAC stamping codes that use an alternate symbol	Alternate Stamping	\$4/Cyl	Alternate Stamping	\$4/Cyl

*Cylinder face stamping not available for Access 3, Pyramid, or Security products

Notes:

1. CMK Construction master keying charge is in addition to master keying charge.
2. CMK Construction master keying is not available in interchangeable core, Access 3, Pyramid, or Security series.
3. Pyramid series is not available keyed random.
4. Security series is not available 0-bitted.

Strike Options*

Lip Length	ANSI Straight Lip - Specify Quick Code	ANSI Curved Lip - Specify Quick Code	Add or Deduct
7/8"	SS078	N/A	No Charge

* If door thickness is standard or has been specified and no special door or frame condition exist, then only the first two characters of the optional strike Quick Code must be specified (e.g. "SA").

The correct lip length will be determined by our order entry system based on the standard or specified door thickness.

BL6600 Series Multi-Point Locks



USA & Canada Prices Effective March 3, 2025

Door Thickness with Locksets Mortised on Center

Door Thickness	Sectional Rose Trim Specify Quick Code	Escutcheon ^{1,2} Trim Specify Quick Code	Add or Deduct
1-3/4" (standard)	—	—	No Charge

Options

Description	Specify Quick Code	Add or Deduct
Split designs and split finishes	Outside Trim x Inside Trim	Higher set price prevails
Spanner head screws	M02	Add \$30.00 per lockset
Torx® head screws (n/a with N escutcheon)	M04	Add \$36.00 per lockset
Single Occupancy Indicator - Secure/Unsecure (Outside)	M19S*	Add \$185.00 per lockset
Single Occupancy Indicator - Vacant/Occupied (Outside)	M19V*	Add \$185.00 per lockset
Double Occupancy Indicator - Secure/Unsecure (Outside) Secure/Unsecure (Inside)	M19SN*	Add \$370.00 per lockset
Double Indicator Vacant/Occupied (Outside) Secure/Unsecure (Inside)	M19VN*	Add \$370.00 per lockset
Knurling outside and inside	M20**	Add \$212.00 per lockset
Knurling outside only	M21**	Add \$106.00 per lockset
Knurling inside only	M22**	Add \$106.00 per lockset
Abrasive coat outside and inside	M23 ¹	Add \$134.00 per lockset
Abrasive coat inside only	M24 ¹	Add \$67.00 per lockset
Abrasive coat outside only	M25 ¹	Add \$67.00 per lockset

** All levers provided in a powder coat finish will be supplied with an abrasive coating.

Thumbturn Options

Specify door thickness	Specify Quick Code	Add or Deduct
Ergonomic	M34 ²	Add \$22.00 per TT
Decorative	MT1	No Charge
Decorative square	MT2	No Charge
Decorative cylinder	MT3	No Charge



MT1



MT2



MT3

Notes:

1. Not available with Vineyard™ or Muséo® levers.
2. M34 is not available with M19N, M19VN or M19SN.

Note: Thumbturn backplate will match shape of rose chosen (i.e. round or square)

Strike Options

Part Number	Description
726F577	Top Strike Pack
726F587	Bottom Strike Pack
726F607	Center Strike Pack

Note: Concealed vertical rods, top & bottom latches, and the lockbody cassette will be factory installed. All other hardware components are shipped directly to the customer and must be installed by a factory trained installer. Invoices for the door will be separate from the hardware invoice. The hardware invoice will include the concealed vertical assembly and the trim components.

FE6700

Storm Shutter Multi-Point Latching System

USA & Canada Prices Effective March 3, 2025

Standard Features

Handing

Device is handed

Shutter Thickness

FE6700 is for use with standard 1-3/4" thick shutters

Cylinder Furnished with:

Brass, 6-pin, L4 keyway, 0-bitted, Optional cylinders available; see Quick Codes

Warranty

Seven-year limited

UL Approved

Meets FEMA P320 (2014), P361 (2015) and ICC 500-(2014/2020) for inswing shutters 2'8" w x 3'00"h min to 4'0" w x 6'8" h max.

Solid brass lever and heavy duty escutcheon

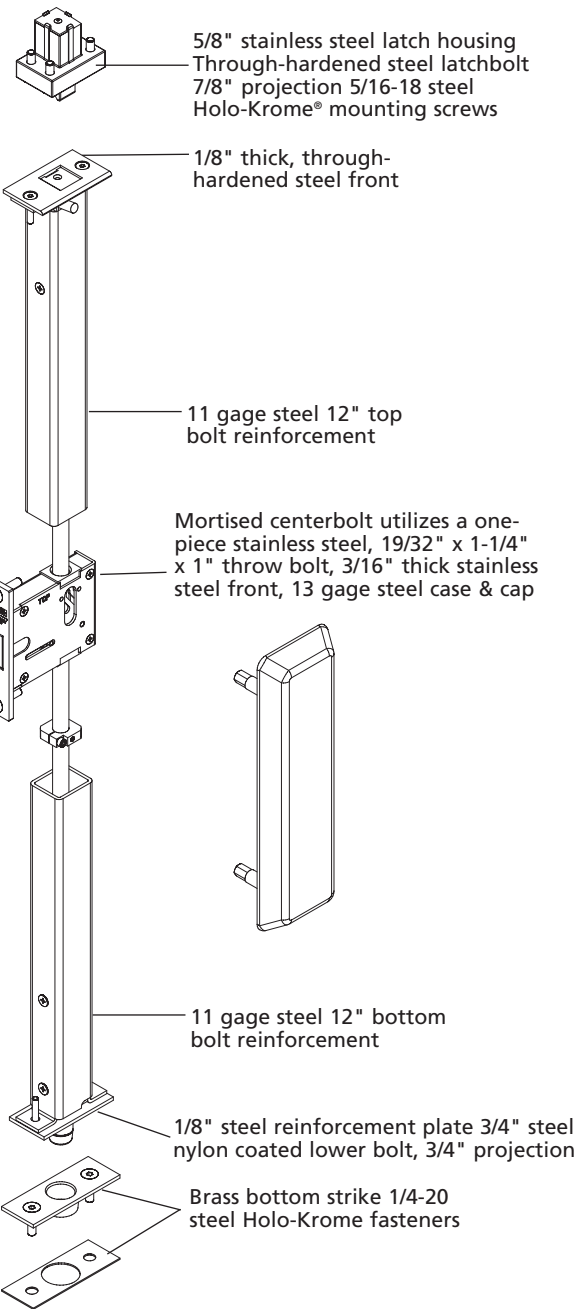
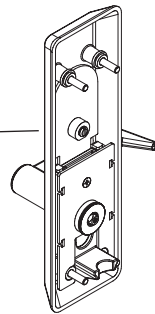

Ordering Example

Stock Order

Quantity	Series/ Function	Trim	Finish	Hand	Shutter Height
100	FE6780	FSH	626	RH	H0400

FE6700

Storm Shutter Multi-Point Latching System

USA & Canada Prices Effective March 3, 2025

Lever: Solid cast
Escutcheon: Forged

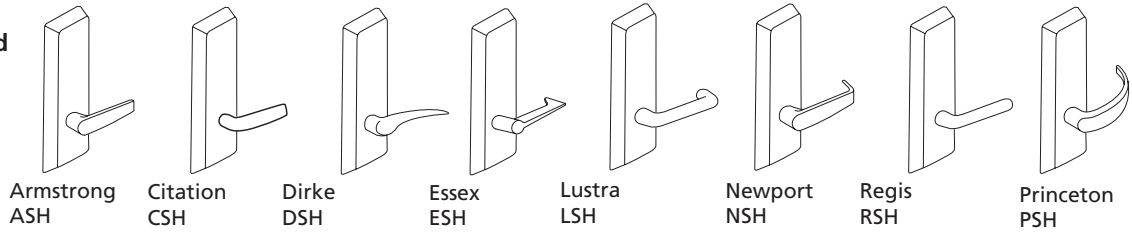

FE6700 Series

Function	Description	ASH, CSH, DSH, ESH, LSH, NSH, PSH, RSH			
		Finish Group 1		Finish Group 2	
		613E Dark Oxidized Satin Bronze	605 Polished Brass	619 Satin Nickel	
		630 Satin Stainless Steel(1)	606 Satin Brass	625 Polished Chrome	
		BSP Black Suede Powder Coat	611 Polished Bronze	629 Polished Stainless Steel(1)	
		WSP White Suede Powder Coat	612 Satin Bronze	626 Satin Chrome	
			613 Oil Rubbed Bronze	722 Black Oil Rubbed Bronze	
			618 Polished Nickel		
For Typical Shutter Applications					
FE6780	Passage Lever x Blank Plate		\$5,576.00		\$5,586.00
Optional Functions					
FE6755	Classroom ³				

1. H escutcheon is a brass forging finished to match 629 and 630 finishes.
3. Collar is required depending on length and type of cylinder. See Miscellaneous Options section on page 239.

Lever: Solid Cast
Escutcheon: Forged

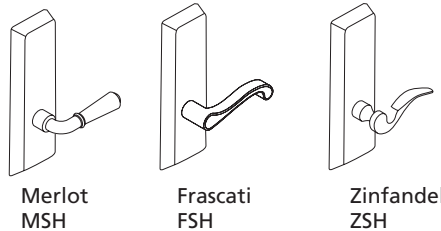

Vineyard™
collection

FE6700 Series

Function	Description	FSH, MSH, ZSH			
		Finish Group 1		Finish Group 2	
		613E Dark Oxidized Satin Bronze	605 Polished Brass	619 Satin Nickel	
		630 Satin Stainless Steel(1)	606 Satin Brass	625 Polished Chrome	
		BSP Black Suede Powder Coat	611 Polished Bronze	722 Black Oil Rubbed Bronze	
		WSP White Suede Powder Coat	612 Satin Bronze		
			613 Oil Rubbed Bronze		
			618 Polished Nickel		
For Typical Shutter Applications					
FE6780	Passage Lever x Blank Plate		\$5,576.00		\$5,586.00
Optional Functions					
FE6755	Classroom ³				

3. Collar is required depending on length and type of cylinder. See Miscellaneous Options section on page 239.

FE6700

Storm Shutter Multi-Point Latching System

USA & Canada Prices Effective March 3, 2025

Cylinder Options*		
Description	Specify Quick Code	Add or Deduct
Conventional 6-pin	6P**	No Charge
Conventional 7-pin	7P	Add \$2.00 per cylinder
Less Standard Cylinder	LC	Deduct \$130.00 per cylinder
Less Concealed Shell Cylinder	PO-LC	Add \$5.00 per lockset
LFIC		
LFIC 6-pin	C6	Add \$112.00 per cylinder
LFIC 6-pin less core	CL6	No Charge
LFIC 6-pin with temporary construction core (Red)	CT6R	Add \$112.00 per cylinder
LFIC 6-pin with temporary construction core (Blue)	CT6B	Add \$112.00 per cylinder
LFIC 6-pin with temporary construction core (Green)	CT6G	Add \$112.00 per cylinder
LFIC 6-pin with temporary disposable core	CT6D	No Charge
LFIC 7-pin	C7	Add \$114.00 per cylinder
LFIC 7-pin less core	CL7	Add \$2.00 per cylinder
LFIC 7-pin with temporary construction core (Red)	CT7R	Add \$114.00 per cylinder
LFIC 7-pin with temporary construction core (Blue)	CT7B	Add \$114.00 per cylinder
LFIC 7-pin with temporary construction core (Green)	CT7G	Add \$114.00 per cylinder
LFIC 7-pin with temporary disposable core	CT7D	Add \$2.00 per cylinder
SFIC		
SFIC 6-pin	C6S	Add \$101.00 per cylinder
LFIC 6-pin with temporary construction core (Blue)	CT6SB	Add \$101.00 per cylinder
SFIC 6-pin with SFIC disposable temporary core	CT6SD	No Charge
SFIC 6-pin with Less Core	CLS6	No Charge
SFIC 7-pin	C7S	Add \$101.00 per cylinder
LFIC 6-pin with temporary construction core (Blue)	CT7SB	Add \$101.00 per cylinder
SFIC 7-pin with SFIC disposable temporary core	CT7SD	No Charge
SFIC 7-pin with Less Core	CLS7	No Charge
Security		
Security ⁴	HS	Add \$171.00 per cylinder
Security LFIC ⁴	CHS	Add \$279.00 per cylinder
Access 3		
Access 3 Patented	AP	No Charge
Access 3 Security	AS	Add \$84.00 per cylinder
Access 3 High Security, UL 437	AHS	Add \$120.00 per cylinder
Access 3 LFIC Patented	ACP	Add \$112.00 per cylinder
Access 3 LFIC Security	ACS	Add \$196.00 per cylinder
Access 3 LFIC High Security, UL 437	ACHS	Add \$232.00 per cylinder
Pyramid		
Pyramid Security fixed core	PS	Add \$90.00 per cylinder
Pyramid Security LFIC	PCS	Add \$196.00 per cylinder
Pyramid High Security fixed core	PHS	Add \$135.00 per cylinder
Pyramid High Security LFIC	PCHS	Add \$241.00 per cylinder
Pyramid LFIC with temporary construction core ³	CTP	Add \$112.00 per cylinder
Pyramid LFIC with temporary disposable core ³	CTPD	No Charge
Pyramid LFIC less core	CLP	No Charge

Notes:

1. CMK Construction master keying charge is in addition to master keying charge.
2. CMK Construction master keying is not available in interchangeable core, Access 3, Pyramid, or Security series.
3. Pyramid series is not available keyed random.
4. Security series is not available 0-bitted.

*Optional dogging cylinder will be furnished with the same mechanism and keyed alike with the trim cylinder, unless otherwise specified.

If different keying or cylinder type is required, specify outside (trim) first, then inside (dogging) cylinder.

**6P cylinder option is supplied in 6-pin, L4 keyway, 0-bitted with two nickel silver keys.

FE6700

Storm Shutter Multi-Point Latching System



USA & Canada Prices Effective March 3, 2025

Cylinder Options (continued) & Keying Options*				
Description	Specify Quick Code		Add or Deduct	
Keying and Keys				
0-bitted with 2 Blank Keys	(standard)		No Charge	
Keyed Random	KR			
Construction Master Keyed ²	CMK		Add \$16.00 per cylinder	
More than 2 Keys	KY# (e.g., KY6)		See page 29 - Cut Keys Section	
Master Keying				
Master keyed (all cylinders except CR8000, CR8020, CR8027, CR8200, CR8500, CR8600, CR8700)	MK		Add \$16.00 per cylinder	
Master keyed Pyramid (except CR8020, CR8027 LFIC cores)	MK			
Master keyed Security (including LFIC cylinder and core)	MK			
Master keyed Access 3 (except CR8500, CR8600, CR8700 LFIC cores)	MK			
Master keyed (CR8000, CR8020, CR8027, CR8200, CR8500, CR8600, CR8700)	MK-IC		No Charge	
Master keyed to customer bittings or sample key	MK-CB		Add \$16.00 per cylinder	
Visual Cylinder/Key Control (VKC)	Cylinders		Keys	
	Stamping	List Price	Stamping	List Price
VKC0 – No stamping except keyway designation (keys will be tagged)	No Stamping	No Charge	No Stamping	\$5/Cyl
VKC1 – Keys only	N/A	N/A	Keyset	No Charge
VKC2 – Cylinder and keys*	Keyset	\$4/Cyl	Keyset	No Charge
VKC3 – Cylinder*	Keyset	\$4/Cyl	Bittings	No Charge
All VKC, VDC, or VAC stamping codes that use an alternate symbol	Alternate Stamping	\$4/Cyl	Alternate Stamping	\$4/Cyl
Concealed Cylinder/Visual Key Control (CKC)	Cylinders		Keys	
	Stamping	List Price	Stamping	List Price
CKC2 – Cylinder and Keys*	Keyset	\$4/Cyl	Keyset	No Charge
CKC3 – Cylinders only*	Keyset	\$4/Cyl	Bittings	No Charge
All CKC, CDC, or CAC stamping codes that use an alternate symbol	Alternate Stamping	\$4/Cyl	Alternate Stamping	\$4/Cyl

*Cylinder face stamping not available for Access 3, Pyramid, or Security products

Notes: 1. CMK Construction master keying charge is in addition to master keying charge and is not available in interchangeable core, Access 3, Pyramid, or Security series.

Shutter Thickness

Description	Specify
1-3/4"	(standard)

Shutter Height Options

Description	Specify
2'8" - 4'6"	H0400
4'6" - 6'8"	H0500

Miscellaneous Options

Description	Specify	Add or Deduct
Torx Screws	M04	Add \$36.00 per lockset
1-1/8" cylinder collar (for 6-pin mortise cylinder) ¹²	721F36	No Charge
1-1/4" cylinder collar (for 7-pin mortise cylinder) ¹²	721F37	No Charge
1-1/2" cylinder collar (for 7-pin IC mortise cylinder) ¹²	721F38	No Charge
MicroShield® Antimicrobial finish coating	630C	Add \$119.00 per lockset
MicroShield Antimicrobial finish coating	626C	Add \$119.00 per lockset

Notes: 1. For optional FE6755 classroom function, collar is required depending on length and type of cylinder.

2. Specify as optional collar when ordering cylinders only.

MP9800 Series Multi-Point Vertical Rod Lock

Standard Features

Handing

Field Reversible.

Doors

1-3/4" (44mm) door thickness standard,
2-1/4" backset standard.

Mounting

Supplied fasteners are for metal doors with through-bolts for trim.

Rods

Steel. Top and bottom bolt travels 7/16" (11mm)
Projection adjustable up to 3/4" (19mm).

Latching

Top and Bottom or Top only (M55).

Trim

Available with all lever designs.

Cylinder

See cylinders page 249.

Applications

Single or Double Door.

Thermal Pins

MP9800A x M55: devices are supplied with ONE thermal pin per
fire-rated device, for installation on pairs of fire-rated doors.

Warranty

5 year.



Featuring Ecoflex Technology

Available Function Combinations:

	Outside Function (E)	Inside Function (N)								
		10	45*	49*	50	52	55*	59*	903*	905*
Blank Escutcheon Plate	01	X	X	X			X	X	X	X
Passage only (No cylinder)	10	X	X	X			X	X		
No outside Operation (No Cylinder); Pull Only	40+	X	X	X					X	X
Class Room Key Outside Unlocks/locks Trim	45	X	X	X						
Key unlocks Trim; Trim retracts latch; Trim relocks when key is removed	49	X	X	X					X	X
Freewheeling Trim; No Outside Operation	50						X	X		
Key outside unlocks/locks O/S trim; Key inside unlocks/locks O/S trim	52					X				
Freewheeling Trim; Key Outside Unlocks/locks Trim	55	X			X		X	X		
Freewheeling Trim; Key unlocks Trim; Trim retracts latch/Trim relocks when key is removed	59	X			X		X	X		
Electrified Trim - Fail Safe	903	X	X	X					X	X
Electrified Trim - Fail Secure	905	X	X	X					X	X

* Not recommended for use on any door used for Life Safety egress + Rigid lever

*Specify voltage desired for 903 and 905 functions (12VDC/24VDC)

Ordering Examples

Qty	Device	Exterior Trim/Function			Interior Trim/Function			Finish	Hand	Door Thickness	Door Height	Misc. Options	Voltage for Electrified Trim
		Lever	Exterior	Function	Lever	Interior	Function						
65	MP9800	D	E	49	D	N	10	605	LHR	D214	H0800	M55	12V

Contract/Detailed Order

Qty	Keyset	Series	Exterior Trim/Function			Interior Trim/Function			Finish	Hand	Door Thickness	Door Hght	Misc. Opts	Cyl Opts	Voltage for Electrified Trim
			Lever	Exterior	Function	Lever	Interior	Function							
36	AA1	MP9800A	102	E	50	102	N	55	626	LHR	D214	H1000	M93	7P	12V

Experience a safer
and more open world

MP9800 Series

Multi-Point Vertical Rod Lock

USA & Canada Prices Effective March 3, 2025

Lever: Solid Cast
Escutcheon: Forged

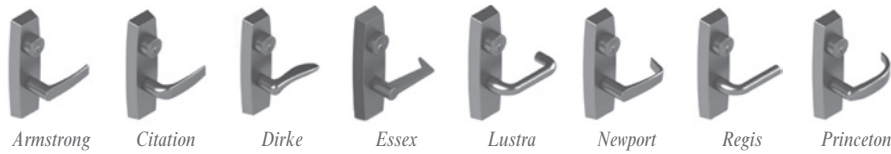

GEORGIA



JACKSON



JOSEF



LASZLO



MARC



SALVADOR



WING



Note: Must designate E for exterior function or N for interior function when specifying order.

MP9800

		613E, 626, BSP, WSP	605 606 611 612 613 618 625
Lever (E) x 01 x Lever (N) x *49	Blank Escutcheon Plate		
Lever (E) x 01 x Lever (N) x *45	Blank Escutcheon Plate		
Lever (E) x 01 x Lever (N) x 10	Blank Escutcheon Plate		
Lever (E) x 01 x Lever (N) x *55	Blank Escutcheon Plate		
Lever (E) x 01 x Lever (N) x 59	Blank Escutcheon Plate		
Lever (E) x 10 x Lever (N) x *49	Passage only (No cylinder)		
Lever (E) x 10 x Lever (N) x *45	Passage only (No cylinder)		
Lever (E) x 10 x Lever (N) x 10	Passage only (No cylinder)		
Lever (E) x 10 x Lever (N) x *55	Passage only (No cylinder)		
Lever (E) x 10 x Lever (N) x *59	Passage only (No cylinder)		
Lever (E) x 40 x Lever (N) x *49	No outside Operation (No Cylinder); Pull Only		
Lever (E) x 40 x Lever (N) x *45	No outside Operation (No Cylinder); Pull Only		
Lever (E) x 40 x Lever (N) x 10	No outside Operation (No Cylinder); Pull Only		
Lever (E) x 45 x Lever (N) x *49	Class Room Key Outside Unlocks/locks Trim		
Lever (E) x 45 x Lever (N) x *45	Class Room Key Outside Unlocks/locks Trim		
Lever (E) x 45 x Lever (N) x 10	Class Room Key Outside Unlocks/locks Trim		
Lever (E) x 49 x Lever (N) x *10	Key unlocks Trim; Trim retracts latch; Trim relocks when key is removed		
Lever (E) x 49 x Lever (N) x *45	Key unlocks Trim; Trim retracts latch; Trim relocks when key is removed		
Lever (E) x 49 x Lever (N) x *49	Key unlocks Trim; Trim retracts latch; Trim relocks when key is removed	\$3,146.00	\$3,226.00

* Not recommended for use on any door used for Life Safety egress.

MP9800 Series
Multi-Point Vertical Rod Lock

USA & Canada Prices Effective March 3, 2025

MP9800 Freewheeling Trim		613E, 626, BSP, WSP	605 606 611 612 613 618 625
Lever (E) x 50 x Lever (N) x *55	Freewheeling Trim; No Outside Operation	\$3,146.00	\$3,226.00
Lever (E) x 50 x Lever (N) x *59	Freewheeling Trim; No Outside Operation		
Lever (E) x 52 x Lever (N) x 52	Key outside unlocks/locks O/S trim; Key inside unlocks/locks O/S trim		
Lever (E) x 55 x Lever (N) x *10	Freewheeling Trim; Key Outside Unlocks/locks Trim		
Lever (E) x 55 x Lever (N) x 50	Freewheeling Trim; Key Outside Unlocks/locks Trim		
Lever (E) x 55 x Lever (N) x *55	Freewheeling Trim; Key Outside Unlocks/locks Trim		
Lever (E) x 55 x Lever (N) x *59	Freewheeling Trim; Key Outside Unlocks/locks Trim		
Lever (E) x 59 x Lever (N) x *10	Freewheeling Trim; Key unlocks Trim; Trim retracts latch/Trim relocks when key is removed		
Lever (E) x 59 x Lever (N) x 50	Freewheeling Trim; Key unlocks Trim; Trim retracts latch/Trim relocks when key is removed		
Lever (E) x 59 x Lever (N) x *55	Freewheeling Trim; Key unlocks Trim; Trim retracts latch/Trim relocks when key is removed		
Lever (E) x 59 x Lever (N) x *59	Freewheeling Trim; Key unlocks Trim; Trim retracts latch/Trim relocks when key is removed		
MP9800 Electromechanical			
Lever (E) x 01 x Lever (N) x *903	Blank Escutcheon Plate	\$3,456.00	\$3,536.00
Lever (E) x 01 x Lever (N) x *905	Blank Escutcheon Plate		
Lever (E) x 40 x Lever (N) x *903	No outside Operation (No Cylinder); Pull Only		
Lever (E) x 40 x Lever (N) x *905	No outside Operation (No Cylinder); Pull Only		
Lever (E) x 49 x Lever (N) x *903	Key unlocks Trim; Trim retracts latch; Trim relocks when key is removed		
Lever (E) x 49 x Lever (N) x *905	Key unlocks Trim; Trim retracts latch; Trim relocks when key is removed		
Lever (E) x 903 x Lever (N) x 10	Electrified Trim - Fail Safe		
Lever (E) x 903 x Lever (N) x *45	Electrified Trim - Fail Safe		
Lever (E) x 905 x Lever (N) x 10	Electrified Trim - Fail Secure		
Lever (E) x 905 x Lever (N) x *45	Electrified Trim - Fail Secure		
Lever (E) x 905 x Lever (N) x *903	Electrified Trim - Fail Secure		
Lever (E) x 905 x Lever (N) x *905	Electrified Trim - Fail Secure		
Lever (E) x 903 x Lever (N) x *903	Electrified Trim - Fail Safe		
Lever (E) x 903 x Lever (N) x *905	Electrified Trim - Fail Safe		

* Not recommended for use on any door used for Life Safety egress.

MP9800 Series

Multi-Point Vertical Rod Lock

USA & Canada Prices Effective March 3, 2025

Lever: Solid Cast
Escutcheon: Forged

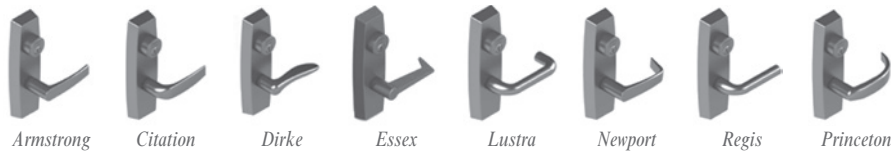

GEORGIA



JACKSON



JOSEF



LASZLO



MARC



SALVADOR



WING



Note: Must designate E for exterior function or N for interior function when specifying order.

MP9800A/B		613E, 626, BSP, WSP	605 606 611 612 613 618 625
Lever (E) x 01 x Lever (N) x *49	Blank Escutcheon Plate	\$3,395.00	\$3,475.00
Lever (E) x 01 x Lever (N) x *45	Blank Escutcheon Plate		
Lever (E) x 01 x Lever (N) x 10	Blank Escutcheon Plate		
Lever (E) x 01 x Lever (N) x *55	Blank Escutcheon Plate		
Lever (E) x 01 x Lever (N) x *59	Blank Escutcheon Plate		
Lever (E) x 10 x Lever (N) x *49	Passage only (No cylinder)		
Lever (E) x 10 x Lever (N) x *45	Passage only (No cylinder)		
Lever (E) x 10 x Lever (N) x 10	Passage only (No cylinder)		
Lever (E) x 10 x Lever (N) x *55	Passage only (No cylinder)		
Lever (E) x 10 x Lever (N) x *59	Passage only (No cylinder)		
Lever (E) x 40 x Lever (N) x *49	No outside Operation (No Cylinder); Pull Only		
Lever (E) x 40 x Lever (N) x *45	No outside Operation (No Cylinder); Pull Only		
Lever (E) x 40 x Lever (N) x 10	No outside Operation (No Cylinder); Pull Only		
Lever (E) x 45 x Lever (N) x *49	Class Room Key Outside Unlocks/locks Trim		
Lever (E) x 45 x Lever (N) x *45	Class Room Key Outside Unlocks/locks Trim		
Lever (E) x 45 x Lever (N) x 10	Class Room Key Outside Unlocks/locks Trim		
Lever (E) x 49 x Lever (N) x *10	Key unlocks Trim; Trim retracts latch; Trim relocks when key is removed		
Lever (E) x 49 x Lever (N) x *45	Key unlocks Trim; Trim retracts latch; Trim relocks when key is removed		
Lever (E) x 49 x Lever (N) x *49	Key unlocks Trim; Trim retracts latch; Trim relocks when key is removed		

* Not recommended for use on any door used for Life Safety egress.

MP9800 Series

Multi-Point Vertical Rod Lock

USA & Canada Prices Effective March 3, 2025

MP9800A/B Freewheeling Trim		613E, 626, BSP, WSP	605 606 611 612 613 618 625
Lever (E) x 50 x Lever (N) x *55	Freewheeling Trim; No Outside Operation	\$3,395.00	\$3,475.00
Lever (E) x 50 x Lever (N) x *59	Freewheeling Trim; No Outside Operation		
Lever (E) x 52 x Lever (N) x 52	Key outside unlocks/locks O/S trim; Key inside unlocks/locks O/S trim		
Lever (E) x 55 x Lever (N) x *10	Freewheeling Trim; Key Outside Unlocks/locks Trim		
Lever (E) x 55 x Lever (N) x 50	Freewheeling Trim; Key Outside Unlocks/locks Trim		
Lever (E) x 55 x Lever (N) x *55	Freewheeling Trim; Key Outside Unlocks/locks Trim		
Lever (E) x 55 x Lever (N) x *59	Freewheeling Trim; Key Outside Unlocks/locks Trim		
Lever (E) x 59 x Lever (N) x *10	Freewheeling Trim; Key unlocks Trim; Trim retracts latch/Trim relocks when key is removed		
Lever (E) x 59 x Lever (N) x 50	Freewheeling Trim; Key unlocks Trim; Trim retracts latch/Trim relocks when key is removed		
Lever (E) x 59 x Lever (N) x *55	Freewheeling Trim; Key unlocks Trim; Trim retracts latch/Trim relocks when key is removed		
Lever (E) x 59 x Lever (N) x *59	Freewheeling Trim; Key unlocks Trim; Trim retracts latch/Trim relocks when key is removed		
MP9800A/B Electromechanical			
Lever (E) x 01 x Lever (N) x *903	Blank Escutcheon Plate		
Lever (E) x 01 x Lever (N) x *905	Blank Escutcheon Plate		
Lever (E) x 40 x Lever (N) x *903	No outside Operation (No Cylinder); Pull Only		
Lever (E) x 40 x Lever (N) x *905	No outside Operation (No Cylinder); Pull Only		
Lever (E) x 49 x Lever (N) x *903	Key unlocks Trim; Trim retracts latch; Trim relocks when key is removed		
Lever (E) x 49 x Lever (N) x *905	Key unlocks Trim; Trim retracts latch; Trim relocks when key is removed		
Lever (E) x 903 x Lever (N) x 10	Electrified Trim - Fail Safe		
Lever (E) x 903 x Lever (N) x *45	Electrified Trim - Fail Safe		
Lever (E) x 905 x Lever (N) x 10	Electrified Trim - Fail Secure		
Lever (E) x 905 x Lever (N) x *45	Electrified Trim - Fail Secure		
Lever (E) x 905 x Lever (N) x *903	Electrified Trim - Fail Secure	\$3,937.00	\$4,017.00
Lever (E) x 905 x Lever (N) x *905	Electrified Trim - Fail Secure		
Lever (E) x 903 x Lever (N) x *903	Electrified Trim - Fail Safe		
Lever (E) x 903 x Lever (N) x *905	Electrified Trim - Fail Safe		

* Not recommended for use on any door used for Life Safety egress.

MP9800 Series

Multi-Point Vertical Rod Lock



USA & Canada Prices Effective March 3, 2025

PIET*



**613E, BSP, WSP finishes are not available with 21M levers.

MP9800		613E, 629, 630, BSP, WSP
	Piet 21G, 21L, 21M, 21S, 23M, 25M, 27M	
Lever (E) x 01 x Lever (N) x *49	Blank Escutcheon Plate	\$3,330.00
Lever (E) x 01 x Lever (N) x *45	Blank Escutcheon Plate	
Lever (E) x 01 x Lever (N) x 10	Blank Escutcheon Plate	
Lever (E) x 01 x Lever (N) x *55	Blank Escutcheon Plate	
Lever (E) x 01 x Lever (N) x 59	Blank Escutcheon Plate	
Lever (E) x 10 x Lever (N) x *49	Passage only (No cylinder)	
Lever (E) x 10 x Lever (N) x *45	Passage only (No cylinder)	
Lever (E) x 10 x Lever (N) x 10	Passage only (No cylinder)	
Lever (E) x 10 x Lever (N) x *55	Passage only (No cylinder)	
Lever (E) x 10 x Lever (N) x *59	Passage only (No cylinder)	
Lever (E) x 40 x Lever (N) x *49	No outside Operation (No Cylinder); Pull Only	
Lever (E) x 40 x Lever (N) x *45	No outside Operation (No Cylinder); Pull Only	
Lever (E) x 40 x Lever (N) x 10	No outside Operation (No Cylinder); Pull Only	
Lever (E) x 45 x Lever (N) x *49	Class Room Key Outside Unlocks/locks Trim	
Lever (E) x 45 x Lever (N) x *45	Class Room Key Outside Unlocks/locks Trim	
Lever (E) x 45 x Lever (N) x 10	Class Room Key Outside Unlocks/locks Trim	
Lever (E) x 49 x Lever (N) x *10	Key unlocks Trim; Trim retracts latch; Trim relocks when key is removed	
Lever (E) x 49 x Lever (N) x *45	Key unlocks Trim; Trim retracts latch; Trim relocks when key is removed	
Lever (E) x 49 x Lever (N) x *49	Key unlocks Trim; Trim retracts latch; Trim relocks when key is removed	
MP9800 Freewheeling Trim		
Lever (E) x 50 x Lever (N) x *55	Freewheeling Trim; No Outside Operation	\$3,330.00
Lever (E) x 50 x Lever (N) x *59	Freewheeling Trim; No Outside Operation	
Lever (E) x 52 x Lever (N) x 52	Key outside unlocks/locks O/S trim; Key inside unlocks/locks O/S trim	
Lever (E) x 55 x Lever (N) x *10	Freewheeling Trim; Key Outside Unlocks/locks Trim	
Lever (E) x 55 x Lever (N) x 50	Freewheeling Trim; Key Outside Unlocks/locks Trim	
Lever (E) x 55 x Lever (N) x *55	Freewheeling Trim; Key Outside Unlocks/locks Trim	
Lever (E) x 55 x Lever (N) x *59	Freewheeling Trim; Key Outside Unlocks/locks Trim	
Lever (E) x 59 x Lever (N) x *10	Freewheeling Trim; Key unlocks Trim; Trim retracts latch/Trim relocks when key is removed	
Lever (E) x 59 x Lever (N) x 50	Freewheeling Trim; Key unlocks Trim; Trim retracts latch/Trim relocks when key is removed	
Lever (E) x 59 x Lever (N) x *55	Freewheeling Trim; Key unlocks Trim; Trim retracts latch/Trim relocks when key is removed	
Lever (E) x 59 x Lever (N) x *59	Freewheeling Trim; Key unlocks Trim; Trim retracts latch/Trim relocks when key is removed	
MP9800 Electromechanical		
Lever (E) x 01 x Lever (N) x *903	Blank Escutcheon Plate	\$3,695.00
Lever (E) x 01 x Lever (N) x *905	Blank Escutcheon Plate	
Lever (E) x 40 x Lever (N) x *903	No outside Operation (No Cylinder); Pull Only	
Lever (E) x 40 x Lever (N) x *905	No outside Operation (No Cylinder); Pull Only	
Lever (E) x 49 x Lever (N) x *903	Key unlocks Trim; Trim retracts latch; Trim relocks when key is removed	
Lever (E) x 49 x Lever (N) x *905	Key unlocks Trim; Trim retracts latch; Trim relocks when key is removed	
Lever (E) x 903 x Lever (N) x 10	Electrified Trim - Fail Safe	
Lever (E) x 903 x Lever (N) x *45	Electrified Trim - Fail Safe	
Lever (E) x 905 x Lever (N) x 10	Electrified Trim - Fail Secure	
Lever (E) x 905 x Lever (N) x *45	Electrified Trim - Fail Secure	
Lever (E) x 905 x Lever (N) x *903	Electrified Trim - Fail Secure	\$3,914.00
Lever (E) x 905 x Lever (N) x *905	Electrified Trim - Fail Secure	
Lever (E) x 903 x Lever (N) x *903	Electrified Trim - Fail Safe	
Lever (E) x 903 x Lever (N) x *905	Electrified Trim - Fail Safe	

* Not recommended for use on any door used for Life Safety egress.

MP9800 Series

Multi-Point Vertical Rod Lock

USA & Canada Prices Effective March 3, 2025

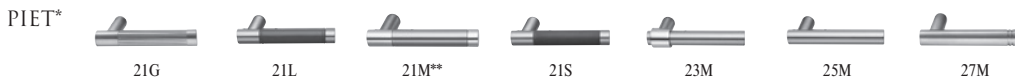

**613E, BSP, WSP finishes are not available with 21M levers.

MP9800A/B		613E, 629, 630, BSP, WSP
	Piet 21G, 21L, 21M, 21S, 23M, 25M, 27M	
Lever (E) x 01 x Lever (N) x *49	Blank Escutcheon Plate	\$3,579.00
Lever (E) x 01 x Lever (N) x *45	Blank Escutcheon Plate	
Lever (E) x 01 x Lever (N) x 10	Blank Escutcheon Plate	
Lever (E) x 01 x Lever (N) x *55	Blank Escutcheon Plate	
Lever (E) x 01 x Lever (N) x 59	Blank Escutcheon Plate	
Lever (E) x 10 x Lever (N) x *49	Passage only (No cylinder)	
Lever (E) x 10 x Lever (N) x *45	Passage only (No cylinder)	
Lever (E) x 10 x Lever (N) x 10	Passage only (No cylinder)	
Lever (E) x 10 x Lever (N) x *55	Passage only (No cylinder)	
Lever (E) x 10 x Lever (N) x *59	Passage only (No cylinder)	
Lever (E) x 40 x Lever (N) x *49	No outside Operation (No Cylinder); Pull Only	
Lever (E) x 40 x Lever (N) x *45	No outside Operation (No Cylinder); Pull Only	
Lever (E) x 40 x Lever (N) x 10	No outside Operation (No Cylinder); Pull Only	
Lever (E) x 45 x Lever (N) x *49	Class Room Key Outside Unlocks/locks Trim	
Lever (E) x 45 x Lever (N) x *45	Class Room Key Outside Unlocks/locks Trim	
Lever (E) x 45 x Lever (N) x 10	Class Room Key Outside Unlocks/locks Trim	
Lever (E) x 49 x Lever (N) x *10	Key unlocks Trim; Trim retracts latch; Trim relocks when key is removed	
Lever (E) x 49 x Lever (N) x *45	Key unlocks Trim; Trim retracts latch; Trim relocks when key is removed	
Lever (E) x 49 x Lever (N) x *49	Key unlocks Trim; Trim retracts latch; Trim relocks when key is removed	
MP9800A/B Freewheeling Trim		
Lever (E) x 50 x Lever (N) x *55	Freewheeling Trim; No Outside Operation	\$3,579.00
Lever (E) x 50 x Lever (N) x *59	Freewheeling Trim; No Outside Operation	
Lever (E) x 52 x Lever (N) x 52	Key outside unlocks/locks O/S trim; Key inside unlocks/locks O/S trim	
Lever (E) x 55 x Lever (N) x *10	Freewheeling Trim; Key Outside Unlocks/locks Trim	
Lever (E) x 55 x Lever (N) x 50	Freewheeling Trim; Key Outside Unlocks/locks Trim	
Lever (E) x 55 x Lever (N) x *55	Freewheeling Trim; Key Outside Unlocks/locks Trim	
Lever (E) x 55 x Lever (N) x *59	Freewheeling Trim; Key Outside Unlocks/locks Trim	
Lever (E) x 59 x Lever (N) x *10	Freewheeling Trim; Key unlocks Trim; Trim retracts latch/Trim relocks when key is removed	
Lever (E) x 59 x Lever (N) x 50	Freewheeling Trim; Key unlocks Trim; Trim retracts latch/Trim relocks when key is removed	
Lever (E) x 59 x Lever (N) x *55	Freewheeling Trim; Key unlocks Trim; Trim retracts latch/Trim relocks when key is removed	
Lever (E) x 59 x Lever (N) x *59	Freewheeling Trim; Key unlocks Trim; Trim retracts latch/Trim relocks when key is removed	
MP9800A/B Electromechanical		
Lever (E) x 01 x Lever (N) x *903	Blank Escutcheon Plate	\$3,959.00
Lever (E) x 01 x Lever (N) x *905	Blank Escutcheon Plate	
Lever (E) x 40 x Lever (N) x *903	No outside Operation (No Cylinder); Pull Only	
Lever (E) x 40 x Lever (N) x *905	No outside Operation (No Cylinder); Pull Only	
Lever (E) x 49 x Lever (N) x *903	Key unlocks Trim; Trim retracts latch; Trim relocks when key is removed	
Lever (E) x 49 x Lever (N) x *905	Key unlocks Trim; Trim retracts latch; Trim relocks when key is removed	
Lever (E) x 903 x Lever (N) x 10	Electrified Trim - Fail Safe	\$4,177.00
Lever (E) x 903 x Lever (N) x *45	Electrified Trim - Fail Safe	
Lever (E) x 905 x Lever (N) x 10	Electrified Trim - Fail Secure	
Lever (E) x 905 x Lever (N) x *45	Electrified Trim - Fail Secure	
Lever (E) x 905 x Lever (N) x *903	Electrified Trim - Fail Secure	
Lever (E) x 905 x Lever (N) x *905	Electrified Trim - Fail Secure	
Lever (E) x 903 x Lever (N) x *903	Electrified Trim - Fail Safe	
Lever (E) x 903 x Lever (N) x *905	Electrified Trim - Fail Safe	

* Not recommended for use on any door used for Life Safety egress.

MP9800 Series

Multi-Point Vertical Rod Lock

JOSEF



GEORGES



USA & Canada Prices Effective March 3, 2025

MP9800		613E, 626, BSP, WSP	605 606 611 612 613 618 625
	Josef, Georges Levers		
Lever (E) x 01 x Lever (N) x *49	Blank Escutcheon Plate		
Lever (E) x 01 x Lever (N) x *45	Blank Escutcheon Plate		
Lever (E) x 01 x Lever (N) x 10	Blank Escutcheon Plate		
Lever (E) x 01 x Lever (N) x *55	Blank Escutcheon Plate		
Lever (E) x 01 x Lever (N) x 59	Blank Escutcheon Plate		
Lever (E) x 10 x Lever (N) x *49	Passage only (No cylinder)		
Lever (E) x 10 x Lever (N) x *45	Passage only (No cylinder)		
Lever (E) x 10 x Lever (N) x 10	Passage only (No cylinder)		
Lever (E) x 10 x Lever (N) x *55	Passage only (No cylinder)		
Lever (E) x 10 x Lever (N) x *59	Passage only (No cylinder)		
Lever (E) x 40 x Lever (N) x *49	No outside Operation (No Cylinder); Pull Only		
Lever (E) x 40 x Lever (N) x *45	No outside Operation (No Cylinder); Pull Only		
Lever (E) x 40 x Lever (N) x 10	No outside Operation (No Cylinder); Pull Only		
Lever (E) x 45 x Lever (N) x *49	Class Room Key Outside Unlocks/locks Trim		
Lever (E) x 45 x Lever (N) x *45	Class Room Key Outside Unlocks/locks Trim		
Lever (E) x 45 x Lever (N) x 10	Class Room Key Outside Unlocks/locks Trim		
Lever (E) x 49 x Lever (N) x *10	Key unlocks Trim; Trim retracts latch; Trim relocks when key is removed		
Lever (E) x 49 x Lever (N) x *45	Key unlocks Trim; Trim retracts latch; Trim relocks when key is removed		
Lever (E) x 49 x Lever (N) x *49	Key unlocks Trim; Trim retracts latch; Trim relocks when key is removed		
		\$3,253.00	\$3,330.00
MP9800 Freewheeling Trim			
Lever (E) x 50 x Lever (N) x *55	Freewheeling Trim; No Outside Operation		
Lever (E) x 50 x Lever (N) x *59	Freewheeling Trim; No Outside Operation		
Lever (E) x 52 x Lever (N) x 52	Key outside unlocks/locks O/S trim; Key inside unlocks/locks O/S trim		
Lever (E) x 55 x Lever (N) x *10	Freewheeling Trim; Key Outside Unlocks/locks Trim		
Lever (E) x 55 x Lever (N) x 50	Freewheeling Trim; Key Outside Unlocks/locks Trim		
Lever (E) x 55 x Lever (N) x *55	Freewheeling Trim; Key Outside Unlocks/locks Trim		
Lever (E) x 55 x Lever (N) x *59	Freewheeling Trim; Key Outside Unlocks/locks Trim		
Lever (E) x 59 x Lever (N) x *10	Freewheeling Trim; Key unlocks Trim; Trim retracts latch/Trim relocks when key is removed		
Lever (E) x 59 x Lever (N) x 50	Freewheeling Trim; Key unlocks Trim; Trim retracts latch/Trim relocks when key is removed		
Lever (E) x 59 x Lever (N) x *55	Freewheeling Trim; Key unlocks Trim; Trim retracts latch/Trim relocks when key is removed		
Lever (E) x 59 x Lever (N) x *59	Freewheeling Trim; Key unlocks Trim; Trim retracts latch/Trim relocks when key is removed		
		\$3,253.00	\$3,330.00
MP9800 Electromechanical			
Lever (E) x 01 x Lever (N) x *903	Blank Escutcheon Plate		
Lever (E) x 01 x Lever (N) x *905	Blank Escutcheon Plate		
Lever (E) x 40 x Lever (N) x *903	No outside Operation (No Cylinder); Pull Only		
Lever (E) x 40 x Lever (N) x *905	No outside Operation (No Cylinder); Pull Only		
Lever (E) x 49 x Lever (N) x *903	Key unlocks Trim; Trim retracts latch; Trim relocks when key is removed		
Lever (E) x 49 x Lever (N) x *905	Key unlocks Trim; Trim retracts latch; Trim relocks when key is removed		
Lever (E) x 903 x Lever (N) x 10	Electrified Trim - Fail Safe		
Lever (E) x 903 x Lever (N) x *45	Electrified Trim - Fail Safe		
Lever (E) x 905 x Lever (N) x 10	Electrified Trim - Fail Secure		
Lever (E) x 905 x Lever (N) x *45	Electrified Trim - Fail Secure		
Lever (E) x 905 x Lever (N) x *903	Electrified Trim - Fail Secure		
Lever (E) x 905 x Lever (N) x *905	Electrified Trim - Fail Secure		
Lever (E) x 903 x Lever (N) x *903	Electrified Trim - Fail Safe		
Lever (E) x 903 x Lever (N) x *905	Electrified Trim - Fail Safe		
		\$3,618.00	\$3,695.00
		\$3,837.00	\$3,914.00

MP9800 Series

Multi-Point Vertical Rod Lock

JOSEF



GEORGES



USA & Canada Prices Effective March 3, 2025

MP9800A/B		613E, 626, BSP, WSP	605 606 611 612 613 618 625
	Josef, Georges Levers		
Lever (E) x 01 x Lever (N) x *49	Blank Escutcheon Plate		
Lever (E) x 01 x Lever (N) x *45	Blank Escutcheon Plate		
Lever (E) x 01 x Lever (N) x 10	Blank Escutcheon Plate		
Lever (E) x 01 x Lever (N) x *55	Blank Escutcheon Plate		
Lever (E) x 01 x Lever (N) x 59	Blank Escutcheon Plate		
Lever (E) x 10 x Lever (N) x *49	Passage only (No cylinder)		
Lever (E) x 10 x Lever (N) x *45	Passage only (No cylinder)		
Lever (E) x 10 x Lever (N) x 10	Passage only (No cylinder)		
Lever (E) x 10 x Lever (N) x *55	Passage only (No cylinder)		
Lever (E) x 10 x Lever (N) x *59	Passage only (No cylinder)	\$3,502.00	\$3,665.00
Lever (E) x 40 x Lever (N) x *49	No outside Operation (No Cylinder); Pull Only		
Lever (E) x 40 x Lever (N) x *45	No outside Operation (No Cylinder); Pull Only		
Lever (E) x 40 x Lever (N) x 10	No outside Operation (No Cylinder); Pull Only		
Lever (E) x 45 x Lever (N) x *49	Class Room Key Outside Unlocks/locks Trim		
Lever (E) x 45 x Lever (N) x *45	Class Room Key Outside Unlocks/locks Trim		
Lever (E) x 45 x Lever (N) x 10	Class Room Key Outside Unlocks/locks Trim		
Lever (E) x 49 x Lever (N) x *10	Key unlocks Trim; Trim retracts latch; Trim relocks when key is removed		
Lever (E) x 49 x Lever (N) x *45	Key unlocks Trim; Trim retracts latch; Trim relocks when key is removed		
Lever (E) x 49 x Lever (N) x *49	Key unlocks Trim; Trim retracts latch; Trim relocks when key is removed		
MP9800A/B Freewheeling Trim			
Lever (E) x 50 x Lever (N) x *55	Freewheeling Trim; No Outside Operation		
Lever (E) x 50 x Lever (N) x *59	Freewheeling Trim; No Outside Operation		
Lever (E) x 52 x Lever (N) x 52	Key outside unlocks/locks O/S trim; Key inside unlocks/locks O/S trim		
Lever (E) x 55 x Lever (N) x *10	Freewheeling Trim; Key Outside Unlocks/locks Trim		
Lever (E) x 55 x Lever (N) x 50	Freewheeling Trim; Key Outside Unlocks/locks Trim		
Lever (E) x 55 x Lever (N) x *55	Freewheeling Trim; Key Outside Unlocks/locks Trim	\$3,502.00	\$3,665.00
Lever (E) x 55 x Lever (N) x *59	Freewheeling Trim; Key Outside Unlocks/locks Trim		
Lever (E) x 59 x Lever (N) x *10	Freewheeling Trim; Key unlocks Trim; Trim retracts latch/Trim relocks when key is removed		
Lever (E) x 59 x Lever (N) x 50	Freewheeling Trim; Key unlocks Trim; Trim retracts latch/Trim relocks when key is removed		
Lever (E) x 59 x Lever (N) x *55	Freewheeling Trim; Key unlocks Trim; Trim retracts latch/Trim relocks when key is removed		
Lever (E) x 59 x Lever (N) x *59	Freewheeling Trim; Key unlocks Trim; Trim retracts latch/Trim relocks when key is removed		
MP9800A/B Electromechanical			
Lever (E) x 01 x Lever (N) x *903	Blank Escutcheon Plate		
Lever (E) x 01 x Lever (N) x *905	Blank Escutcheon Plate		
Lever (E) x 40 x Lever (N) x *903	No outside Operation (No Cylinder); Pull Only		
Lever (E) x 40 x Lever (N) x *905	No outside Operation (No Cylinder); Pull Only		
Lever (E) x 49 x Lever (N) x *903	Key unlocks Trim; Trim retracts latch; Trim relocks when key is removed	\$3,882.00	\$3,959.00
Lever (E) x 49 x Lever (N) x *905	Key unlocks Trim; Trim retracts latch; Trim relocks when key is removed		
Lever (E) x 903 x Lever (N) x 10	Electrified Trim - Fail Safe		
Lever (E) x 903 x Lever (N) x *45	Electrified Trim - Fail Safe		
Lever (E) x 905 x Lever (N) x 10	Electrified Trim - Fail Secure		
Lever (E) x 905 x Lever (N) x *45	Electrified Trim - Fail Secure		
Lever (E) x 905 x Lever (N) x *903	Electrified Trim - Fail Secure		
Lever (E) x 905 x Lever (N) x *905	Electrified Trim - Fail Secure	\$4,100.00	\$4,177.00
Lever (E) x 903 x Lever (N) x *903	Electrified Trim - Fail Safe		
Lever (E) x 903 x Lever (N) x *905	Electrified Trim - Fail Safe		

* Not recommended for use on any door used for Life Safety egress.

MP9800 Series

Multi-Point Vertical Rod Lock



USA & Canada Prices Effective March 3, 2025

Cylinder Options*		
Description	Specify Quick Code	Add or Deduct
Conventional 6-pin	6P**	Add \$130.00 per cylinder
Conventional 7-pin	7P	Add \$132.00 per cylinder
LFIC		
LFIC 6-pin	C6	Add \$242.00 per cylinder
LFIC 6-pin less core	CL6	Add \$130.00 per cylinder
LFIC 6-pin with temporary construction core (Red)	CT6R	Add \$242.00 per cylinder
LFIC 6-pin with temporary construction core (Blue)	CT6B	Add \$242.00 per cylinder
LFIC 6-pin with temporary construction core (Green)	CT6G	Add \$242.00 per cylinder
LFIC 6-pin with temporary disposable core	CT6D	Add \$130.00 per cylinder
LFIC 7-pin	C7	Add \$246.00 per cylinder
LFIC 7-pin less core	CL7	Add \$132.00 per cylinder
LFIC 7-pin with temporary construction core (Red)	CT7R	Add \$246.00 per cylinder
LFIC 7-pin with temporary construction core (Blue)	CT7B	Add \$246.00 per cylinder
LFIC 7-pin with temporary construction core (Green)	CT7G	Add \$246.00 per cylinder
LFIC 7-pin with temporary disposable core	CT7D	Add \$132.00 per cylinder
SFIC		
SFIC 6-pin	C6S	Add \$231.00 per cylinder
SFIC 6-pin with temporary construction core (Blue)	CT6SB	Add \$231.00 per cylinder
SFIC 6-pin with SFIC disposable temporary core	CT6SD	Add \$130.00 per cylinder
SFIC 6-pin with Less Core	CLS6	Add \$130.00 per cylinder
SFIC 7-pin	C7S	Add \$231.00 per cylinder
SFIC 7-pin with temporary construction core (Blue)	CT7SB	Add \$231.00 per cylinder
SFIC 7-pin with SFIC disposable temporary core	CT7SD	Add \$130.00 per cylinder
SFIC 7-pin with Less Core	CLS7	Add \$130.00 per cylinder
Security		
Security ⁴	HS	Add \$301.00 per cylinder
Security LFIC ⁴	CHS	Add \$409.00 per cylinder
Access 3		
Access 3 Patented	AP	Add \$130.00 per cylinder
Access 3 Security	AS	Add \$214.00 per cylinder
Access 3 High Security, UL 437	AHS	Add \$250.00 per cylinder
Access 3 LFIC Patented	ACP	Add \$242.00 per cylinder
Access 3 LFIC Security	ACS	Add \$326.00 per cylinder
Access 3 LFIC High Security, UL 437	ACHS	Add \$362.00 per cylinder
Pyramid		
Pyramid Security fixed core	PS	Add \$220.00 per cylinder
Pyramid Security LFIC	PCS	Add \$326.00 per cylinder
Pyramid High Security fixed core	PHS	Add \$265.00 per cylinder
Pyramid High Security LFIC	PCHS	Add \$371.00 per cylinder
Pyramid LFIC with temporary construction core ³	CTP	Add \$242.00 per cylinder
Pyramid LFIC with temporary disposable core ³	CTPD	Add \$130.00 per cylinder
Pyramid LFIC less core	CLP	Add \$130.00 per cylinder

Notes:

1. CMK Construction master keying charge is in addition to master keying charge.
2. CMK Construction master keying is not available in interchangeable core, Access 3, Pyramid, or Security series.
3. Pyramid series is not available keyed random.
4. Security series is not available 0-bitted.

*Optional dogging cylinder will be furnished with the same mechanism and keyed alike with the trim cylinder, unless otherwise specified.

If different keying or cylinder type is required, specify outside (trim) first, then inside (dogging) cylinder.

**6P cylinder option is supplied in 6-pin, L4 keyway, 0-bitted with two nickel silver keys.

MP9800 Series

Multi-Point Vertical Rod Lock

USA & Canada Prices Effective March 3, 2025

Cylinder Options (continued) & Keying Options*				
Description	Specify Quick Code		Add or Deduct	
Keying and Keys				
0-bitted with 2 Blank Keys	(standard)		No Charge	
Keyed Random	KR			
Construction Master Keyed ²	CMK		Add \$16.00 per cylinder	
More than 2 Keys	KY# (e.g., KY6)		See page 29 - Cut Keys Section	
Master Keying				
Master keyed (all cylinders except CR8000, CR8020, CR8027, CR8200, CR8500, CR8600, CR8700)	MK		Add \$16.00 per cylinder	
Master keyed Pyramid (except CR8020, CR8027 LFIC cores)	MK			
Master keyed Security (including LFIC cylinder and core)	MK			
Master keyed Access 3 (except CR8500, CR8600, CR8700 LFIC cores)	MK			
Master keyed (CR8000, CR8020, CR8027, CR8200, CR8500, CR8600, CR8700)	MK-IC		No Charge	
Master keyed to customer bittings or sample key	MK-CB		Add \$16.00 per cylinder	
Visual Cylinder/Key Control (VKC)	Cylinders		Keys	
	Stamping	List Price	Stamping	List Price
VKC0 – No stamping except keyway designation (keys will be tagged)	No Stamping	No Charge	No Stamping	\$5/Cyl
VKC1 – Keys only	N/A	N/A	Keyset	No Charge
VKC2 – Cylinder and keys*	Keyset	\$4/Cyl	Keyset	No Charge
VKC3 – Cylinder*	Keyset	\$4/Cyl	Bittings	No Charge
All VKC, VDC, or VAC stamping codes that use an alternate symbol	Alternate Stamping	\$4/Cyl	Alternate Stamping	\$4/Cyl
Concealed Cylinder/Visual Key Control (CKC)	Cylinders		Keys	
	Stamping	List Price	Stamping	List Price
CKC2 – Cylinder and Keys*	Keyset	\$4/Cyl	Keyset	No Charge
CKC3 – Cylinders only*	Keyset	\$4/Cyl	Bittings	No Charge
All CKC, CDC, or CAC stamping codes that use an alternate symbol	Alternate Stamping	\$4/Cyl	Alternate Stamping	\$4/Cyl

*Cylinder face stamping not available for Access 3, Pyramid, or Security products

Notes:

1. CMK Construction master keying charge is in addition to master keying charge and is not available in interchangeable core, Access 3, Pyramid, or Security series.

MP9800 Series

Multi-Point Vertical Rod Lock



USA & Canada Prices Effective March 3, 2025

Door Height Options	Specify	Add or Deduct
7'0"	Standard	No Charge
7'2"	H702	
7'6"	H706	
8'0"	H0800	
9'0"	H0900	
10'0"	H1000	
Door Thickness	Specify	Add or Deduct
1-3/4" (44mm)	Standard	No Charge
2" (51mm)	D200	No Charge
2-1/4" (57mm)	D214	No Charge
Motorized Electric Latch Retraction	Specify	Add or Deduct
Electric Latch Retraction	MELR	Add \$1277.00
Miscellaneous Options	Specify	Add or Deduct
Spanner Head Screw	M02	Add \$51.00 per device
Torx® head screws	M04	Add \$71.00 per device
Knurling outside and inside	M20*	Add \$219.00 per device
Knurling outside only ¹	M21*	Add \$105.00 per device
Knurling inside only	M22*	Add \$114.00 per device
Abrasive coat outside and inside (trim and device)	M23	Add \$135.00 per device
Abrasive coat inside only (device side)	M24	Add \$72.00 per device
Abrasive coat outside only (trim side)	M25	Add \$63.00 per device
Less bottom vertical rod	M55	No Charge
Latchbolt Monitoring	M91	Add \$340.00
O/S Lever Monitoring	M93	Add \$333.00
I/S Lever Monitoring	M92	Add \$333.00
Windstorm	M107	Add \$127.00 per device
Aluminum Door	MPAD	No Charge
Rectangular Back Plate (Required for Wood Door - MPWD)	MPER	
Back Plate (Required for Wood Door - MPWD)	MPES	
Lever Hold Back	MPHB	Add \$30.00 per device
Fire Rated Wood Door	MPWD	No Charge
aux control (classroom)	AUX155	Add \$919.00 per device
aux control (storeroom)	AUX159	Add \$919.00 per device
MicroShield® Antimicrobial finish coating	626C	Add \$99.00 (Exit Devices & Trims (ordered separately) Add \$119.00 (Exit Devices & Outside Trims (ordered together)
MicroShield® Antimicrobial finish coating	630C	Add \$99.00 (Exit Devices & Trims (ordered separately) Add \$119.00 (Exit Devices & Outside Trims (ordered together)

1. Not available with Vineyard™ or Muséo® levers.

*All levers provided in a powder coat finish will be supplied with an abrasive coating.

Blank Page

MicroShield® How to Order, Pricing	256
------------------------------------	-----

ED2000 Pushpad Series:

ED2000 Series Standard Features	257
ED2000 Series Ordering Example	258
ED2000 Series: Rim ED2000, Vertical Rod ED2400	259
ED2000 Series Rose Trim Designs: A5 Armstrong, N5 Newport, PR5 Princeton	260
ED2000 Series Rose Trim Flat Plate Trim F1 Flat Plate, Pull Trim Design P8 Wing Pull, Trim Design K1 Key Only	261
ED2000 Series Cylinder Options, Rim Cylinder Trim	262
ED2000 Series Cylinder Options (continued) & Keying Options	263
ED2000 Series Keying, Door Width, Door Thickness, Door Height Options, Miscellaneous & Strike Options	264
ED2000 Series Alarm Kit, Mullions, Door Height Options, Mullions Cylinder Options	265

ED3000 Crossbar Series:

ED3000 Series Standard Features	266
ED3000 Series Ordering Examples	267
ED3000 Series: Rim ED3200	268
ED3000 Series: Surface Vertical Rod ED3400 Series, Mortise ED3600 Series	269
ED3000 Series Escutcheon Trim Designs: A33 Armstrong, C33 Citation, D33 Dirke, L33 Lustra	270
ED3000 Series Escutcheon Trim Designs: N33 Newport, PR33 Princeton, R33 Regis	271
ED3000 Series Escutcheon Trim Designs: T33 D Grip, T34 Round Grip, T35 Sectional Grip, Auxiliary Control/Inside Lever Assembly: 3357T Nightlatch	272
ED3000 Series Offset Pull Trim & Cylinder Options	273
ED3000 Series Keying Options	274
ED3000 Series Strike Options	275
ED3000 Series Miscellaneous, Door Width, Door Thickness, Door Height Options	276
ED3000 Series Mullions, Removable Mullions, Key Removable Mullions, Mullion Cylinder Options, Ordering Examples	277

PED4000 Narrow Stile Pushpad Series:

PED4000 Series Standard Features	278
PED4000 Series Ordering Examples	279
PED4200 Rim Exit Devices & Levers	280
PED4200 Rim Exit Devices & Grips	281
PED4200 Electrified & Miscellaneous Options	282
PED4600 Mortise Exit Devices & Levers	283
PED4600 Mortise Exit Devices & Grips	284
PED4600 Electrified & Miscellaneous Options	285
PED4800 Concealed Vertical Rod Exit Devices & Levers	286
PED4800 Electrified & Miscellaneous Options	287
PED4000 Series Cylinder Options	288
PED4000 Series Keying Options	289
PED4000 Series Offset Pull Trims, Auxiliary Controls, Door Height, Above Finished Floor, Door Width, Door Thickness Options	290
PED4000 Series Active Dogging Indicator Options	291

Continued on next page.

PED5000 Pushpad Series:

PED5000 Series Standard Features	292
PED5000 Series Ordering Examples	293
PED5200 Rim Exit Devices & Levers	294
PED5200 Rim Exit Devices & Grips	295
PED5200 Electrified & Miscellaneous Options	296
PED5400 Surface Vertical Rod Exit Devices & Levers	297
PED5400 Surface Vertical Rod Exit Devices & Grips	298
PED5400 Electrified & Miscellaneous Options	299
PED5400 FE Surface Vertical Rod Exit Devices & Levers	300
PED5400 FE Electrified & Miscellaneous Options	301
PED5600 Mortise Exit Devices & Levers	302
PED5600 Mortise Exit Devices & Grips	303
PED5600 Electrified & Miscellaneous Options	304
PED5800 Concealed Vertical Rod Exit Devices & Levers	305
PED5800 Electrified & Miscellaneous Options	306
PED5000 Series Cylinder Options	307
PED5000 Series Keying Options	308
PED5000 Series Offset Pull Trims, Auxiliary Controls, Inactive/Active Bar, Door Height, Above Finished Floor, Door Width, Door Thickness Options	309
PED5000 Series Active Dogging Indicator Options	310
PED5000 Series Mullions, Removable Mullions, Key Removable Mullions, Mullions Cylinder Options	311

ED4000 Narrow Stile Pushpad Series:

ED4000 Series How to Order	312
ED4000 Series Standard Features	313
ED4000 Series Ordering Example	314
ED4000 Series: ED4200S, ED4200, ED4400, ED4800	315

ED4000 Series Muséo Pushpad Exit Devices:

ED4000 Series: Muséo Levers with 800 Series Escutcheon: Georgia, Pablo, Jackson, Salvador, Josef Marc Levers	316
ED4000 Series: Muséo Levers with 800 Series Escutcheon: Piet Levers	317

ED4000 Narrow Stile Pushpad Series:

ED4000 Series Escutcheon Trim Designs: A8 Armstrong, C8 Citation, D8 Dirke	318
ED4000 Series Escutcheon Trim Designs: E8 Essex, L8 Lustra, N8 Newport, R8 Regis	319
ED4000 Series Escutcheon Trim Designs: PR8 Princeton, F4 Plate, O8 Plate x Thumbturn	320
ED4000 Series Escutcheon Trim Designs: O14 Plate x Thumbturn, T14 Pull/Thumbpiece, P10 Pull, K1 Key Only	321
ED4000 Series Pull Trim & Accessories	322
ED4000 Series Cylinder & Keying Options	323
ED4000 Series Door Height Options for ED4400, ED4800 Series, Width, Thickness, Strike Options	324
ED4000 Series Miscellaneous Options, Removable Mullion	325

ED5000 Pushpad Series:

ED5000 Series Standard Features	326
ED5000 Series Ordering Examples	327
ED5000 Series: ED5200S, ED5200, ED5400, ED5600, ED5800, ED5000DB	328

Continued on next page.

ED5000 Series: Muséo Levers with 900 Series Escutcheon:

ED5000 Series: Muséo Georgia, Jackson, Josef, Laslo, Marc, Salvador, Levers with 900 Series Escutcheon	329
ED5000 Series: Muséo Josef, Georges Levers with 900 Series Escutcheon	330
ED5000 Series: Muséo Piet Levers with 900 Series Escutcheon	331

ED5000 Pushpad Series:

ED5000 Series Escutcheon Trim Designs: A9 Armstrong, C9 Citation, D9 Dirke	332
ED5000 Series Escutcheon Trim Designs: E9 Essex, L9 Lustra, N9 Newport, R9 Regis	333
ED5000 Series Escutcheon Trim Designs: PR9 Princeton, F9, VT9	334
ED5000 Series Escutcheon Trim Designs: FR9 Frascati, M9 Merlot, Z9 Zinfandel	335
ED5000 Series Escutcheon Trim Designs: TH900 Pull/Thumbpiece, P9 Pull, K1 Key Only	336
ED5000 Series Escutcheon Trim Designs: A4M Armstrong, C9M Citation, D9M Dirke	337
ED5000 Series Escutcheon Trim Designs: E9M Essex, L9M Lustra, N9M Newport	338
ED5000 Series Escutcheon Trim Designs: R9M Regis, PR9M Princeton, F9	339
ED5000 Series Escutcheon Trim Designs: FR9M Frascati, M9M Merlot, Z9M Zinfandel	340
ED5000 Series Escutcheon Trim Designs: TH900, TH9M00 Pull/Thumbpiece, P9M Pull, VT9M, K1M Key Only	341
ED5000 Series Escutcheon Trim Designs: A4M Armstrong, C9M Citation, D9M Dirke, E9 Essex	342
ED5000 Series Escutcheon Trim Designs: L9 Lustra, N9 Newport, R9 Regis, PR9 Princeton	343
ED5000 Series Escutcheon Trim Designs: FR9 Frascati, M9 Merlot, Z9 Zinfandel	344
ED5000 Series Offset Pull Trim P12, P13, P14, Electrified Options, Delayed Egress Device, Retrofit MELR Kit:	345
ED5000 Series Electrified Accessories	346
ED5000 Series Cylinder & Keying Options	347
ED5000 Series Cylinder & Keying Options (continued), Door Height,	348
ED5000 Series Door Width, Thickness, Strike Options, Surface Bolt	349
ED5000 Series Mullions, Removable Mullions, Key Removable Mullions, Mullions Cylinder Options	350

ED7000 Narrow Stile Crossbar Series:

ED7000 Series Standard Features	351
ED7000 Series Ordering Example	352
ED7000 Series: ED7200, ED7400, ED7600, ED7800	353
ED7000 Series Pull Trim Designs: P4 D Grip Pull, P5 Round Grip Pull, P6 Pull, P7 Plate	354
ED7000 Series Escutcheon Trim Designs: C4 Citation, D4 Dirke, O3 D Grip Operator, O4 Round Grip Operator	355
ED7000 Series Escutcheon Trim Designs: O5 Operator, Offset Pull Trim: P12, P13, P14	356
ED7000 Series Cylinder & Keying Options	357
ED7000 Series Cylinder & Keying Options	358
ED7000 Series Strike Options	359
ED7000 Series Door Width, Door Thickness, Door Height, Miscellaneous Options	360
ED7000 Series Mortise Lock Only, Removable Mullion Ordering Example	361

MicroShield®

Look for the *MicroShield* icon.

ED3000
 PED4000
 PED5000
 ED4000
 ED5000
 ED7000

MicroShield®

As part of their promise to provide innovative solutions to their customers, certain ASSA ABLOY Group brands offer the MicroShield® technology, a silver-based antimicrobial coating designed to inhibit the growth of bacteria.

MicroShield® is a registered trademark of ASSA ABLOY Access and Egress Hardware Group, Inc.

Product	Series	MicroShield® Coated Components
Exit Devices	PED4000 and PED5000 Series	Inside rail, push rail, head cover, end cap* Outside trim: levers/pull* and escutcheons

AVAILABLE FINISHES

- MicroShield® is available on 626 and 630. Other finishes available by Special Product Application Request Form only.
- Specify 626C (satin chrome plated) or 630C (satin stainless steel) when ordering.
- MicroShield® coating will be applied over 626 and 630 finishes. All components will match 626.

Note: MicroShield® coating will only be applied to "high touch" components.

HOW TO ORDER

Product	How to Order
Exit Devices & Outside Trims (ordered together)	PED5255 x C855PT x 630C x LHR
Exit Devices & Trims (ordered separately)	N855PT x 630C x RHR

Description	Add
Exit Devices & Outside Trims (ordered together)	Add \$119.00 (when ordered together)
Exit Devices & Trims (ordered separately)	Add \$99.00

Standard Features

Handing

ED2200 Non-handed
ED2400 Handed; specify hand

Door Thickness

1-3/4"

Backset

2-3/4"

Bar Length

36 standard; 42" and 48" available. Easily field cut to size.

Projection

2-1/2"

Trim

Cylinder is not included. See page 275 for cylinder options.

RIM

ED2200
ED2200A

Panic
3 Hour Fire Rated

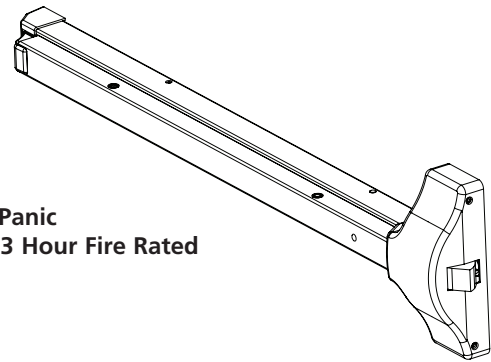

VERTICAL ROD

ED2400
ED2400A

Panic
3 Hour Fire Rated

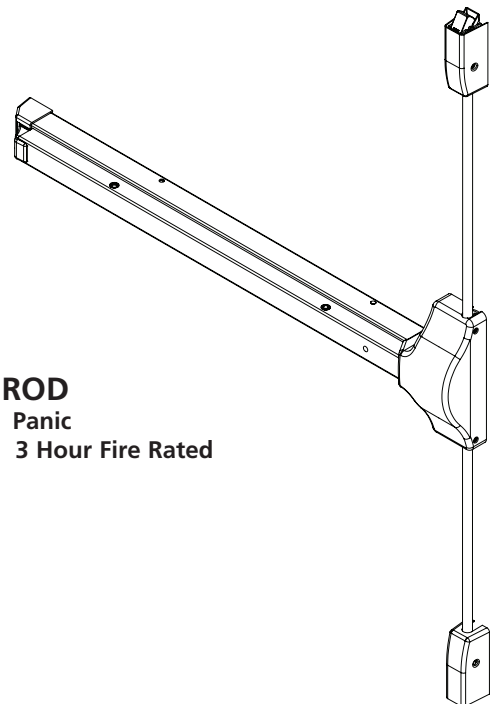

Ordering Example

Rim Exit Device		
Quantity	Exit Device	Finish
20	ED2200	689

Rim Exit Device with Trim

Quantity	Exit Device	Trim/Function	Finish		Hand	Door Thickness	Door Width	Misc. Options
			Trim	Device				
50	ED2200A	A557ET	613	690	RHR	D200	W048	M58

Trim Only (Rim or Vertical Rod)

Quantity	Trim/Function	Finish	Hand
10	N555ET	606	RHR

Vertical Rod Exit Device with Trim

Quantity	Exit Device	Trim/Function	Finish		Hand	Optional Strike	Door Width	Height
			Trim	Device				
50	ED2400	PR510ET	626	689	RHR	S03	W048	H0700

Contract/Detailed Order - Rim Exit Device with Trim

Quantity	Keyset	Exit Device	Trim/Function	Finish		Hand	Door Thickness	Door Width	Optional Cylinder	Keying
				Trim	Device					
50	AA1	ED2200	N555ET	626	689	LHR	D200	W048	C6	VKC3

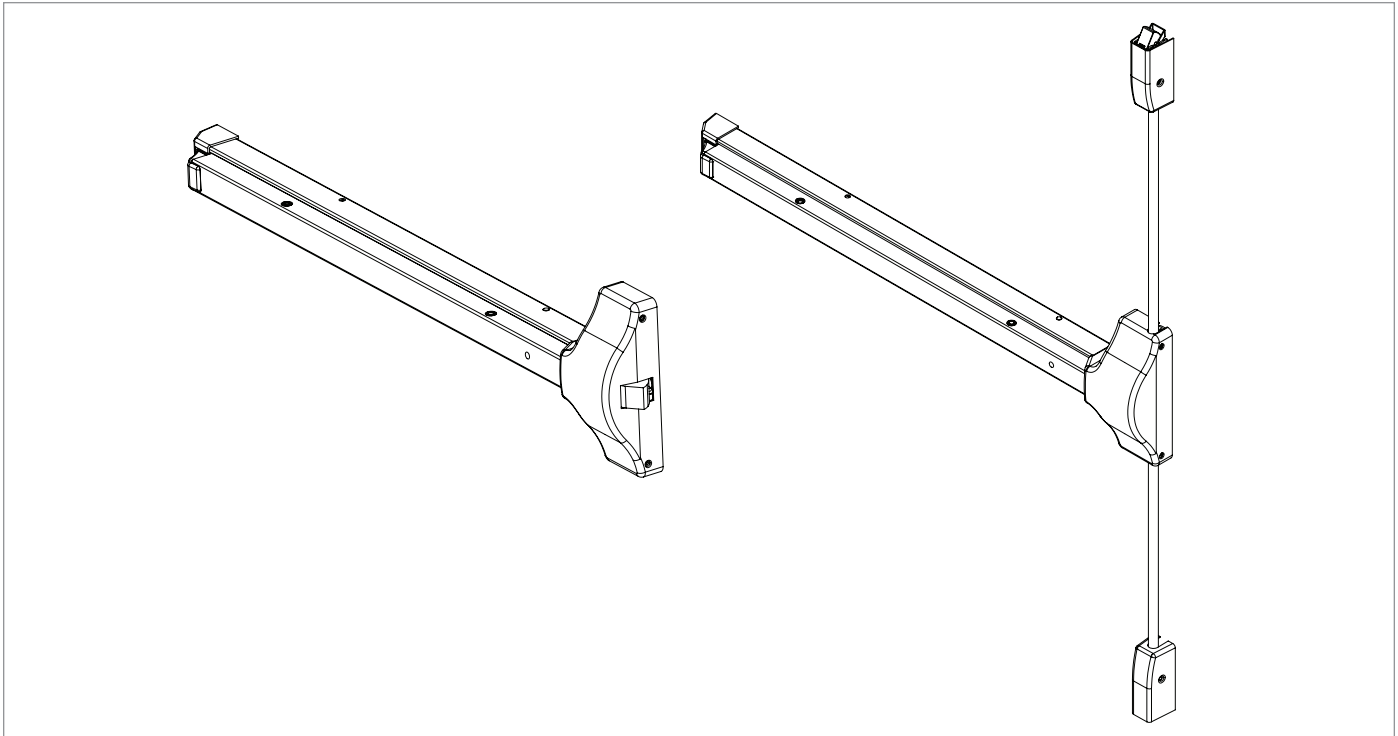

36", 42" and 48" Exit Devices

Includes device, strike(s) and screw pack. No cylinder or trim.

Rim ED2000 Series

Function	Description	Finish: 689, 691, 693, 695, BSP, WSP
ED2200	Panic	\$347.00
ED2200A	3 Hour Fire Rated	\$451.00

Vertical Rod ED2400 Series

Function	Description	Finish: 689, 691, 693, 695, BSP, WSP
ED2400	Panic	\$498.00
ED2400A	3 Hour Fire Rated	\$602.00

Caution: Be sure of your measurements. Exit devices are NOT returnable.

ED2200/ED2400 Rim and Surface Vertical Rod Trim

Cylinder is not included, except where noted.

Rose Trim Design: A5 Armstrong



Lever: Die cast zinc
Cylinder included

Rose: Wrought brass or bronze

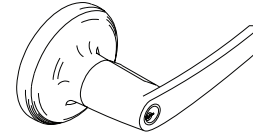

Function	Description	Finish: 605, 606, 611, 612, 613, 613E, 619, 625, 626, 722 BSP
A510ET	Passage	\$182.00
A550ET	Dummy	
A555ET	Classroom	\$226.00
A557ET	Nightlatch ¹	

Rose Trim Design: N5 Newport



Lever: Die cast zinc
Cylinder included

Rose: Wrought brass or bronze

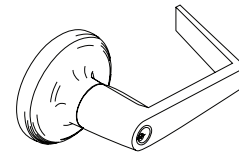

Function	Description	Finish: 605, 606, 611, 612, 613, 613E, 619, 625, 626, 722 BSP
N510ET	Passage	\$182.00
N550ET	Dummy	
N555ET	Classroom	\$226.00
N557ET	Nightlatch ¹	

Rose Trim Design: PR5 Princeton



Lever: Die cast zinc
Cylinder included

Rose: Wrought brass or bronze

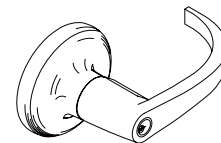

Function	Description	Finish: 605, 606, 611, 612, 613, 613E, 619, 625, 626, 722 BSP
PR510ET	Passage	\$182.00
PR550ET	Dummy	
PR555ET	Classroom	\$226.00
PR557ET	Nightlatch ¹	

Note:
1. Not recommended for use with ED2400 and ED2400A surface vertical rod exit devices.

ED2200/ED2400 Rim and Surface Vertical Rod Trim

Cylinder is not included, except where noted.

Flat Plate Trim Design: F1 Flat Plate

Plate: Steel

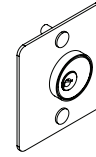

Function	Description	Finish: 689, 691, 695
F1857ET	Nightlatch ¹	\$102.00

Note:

1. Not recommended for use with ED2400 and ED2400A surface vertical rod exit devices.

Pull Trim Design: P8 Wing Pull



Pull: Extruded Aluminum



Function	Description	Finish: 689, 691, 695
P1850ET	Dummy	\$102.00
P1857ET	Nightlatch ¹	

Trim Design: K1 Key Only

Note: Available with cylinder option only.
Example: K157 x 6P
Cylinder option pricing applies.



Function	Description	Finish: 605, 606, 611, 612, 613, 619, 622, 625, 626, 722
K157ET	Nightlatch ¹	\$88.00

Rim Cylinder Trim Options*		
Description	Specify Quick Code	Add or Deduct
Conventional 6-pin	6P**	Add \$130.00 per cylinder
Conventional 7-pin	7P	Add \$132.00 per cylinder
LFIC		
LFIC 6-pin	C6	Add \$242.00 per cylinder
LFIC 6-pin less core	CL6	Add \$130.00 per cylinder
LFIC 6-pin with temporary construction core (Red)	CT6R	Add \$242.00 per cylinder
LFIC 6-pin with temporary construction core (Blue)	CT6B	Add \$242.00 per cylinder
LFIC 6-pin with temporary construction core (Green)	CT6G	Add \$242.00 per cylinder
LFIC 6-pin with temporary disposable core	CT6D	Add \$130.00 per cylinder
LFIC 7-pin	C7	Add \$246.00 per cylinder
LFIC 7-pin less core	CL7	Add \$132.00 per cylinder
LFIC 7-pin with temporary construction core (Red)	CT7R	Add \$246.00 per cylinder
LFIC 7-pin with temporary construction core (Blue)	CT7B	Add \$246.00 per cylinder
LFIC 7-pin with temporary construction core (Green)	CT7G	Add \$246.00 per cylinder
LFIC 7-pin with temporary disposable core	CT7D	Add \$132.00 per cylinder
SFIC		
SFIC 6-pin	C6S	Add \$231.00 per cylinder
SFIC 6-pin with Temporary Construction Core (Blue)	CT6SB	Add \$231.00 per cylinder
SFIC 6-pin Disposable Temporary Core	CT6SD	Add \$130.00 per cylinder
SFIC 6-pin with Less Core	CLS6	Add \$130.00 per cylinder
SFIC 7-pin	C7S	Add \$231.00 per cylinder
SFIC 7-pin with Temporary Construction Core (Blue)	CT7SB	Add \$231.00 per cylinder
SFIC 7-pin Disposable Temporary Core	CT7SD	Add \$130.00 per cylinder
SFIC 7-pin with Less Core	CLS7	Add \$130.00 per cylinder
Security		
Security ⁴	HS	Add \$301.00 per cylinder
Security LFIC ⁴	CHS	Add \$409.00 per cylinder
Access 3		
Access 3 [®] Patented Fixed Core	AP	Add \$130.00 per cylinder
Access 3 [®] Security Fixed Core	AS	Add \$214.00 per cylinder
Access 3 [®] High Security Fixed Core	AHS	Add \$250.00 per cylinder
Access 3 [®] Patented LFIC ¹	ACP	Add \$242.00 per cylinder
Access 3 [®] Security LFIC ¹	ACS	Add \$326.00 per cylinder
Access 3 [®] High Security LFIC ¹	ACHS	Add \$362.00 per cylinder
Pyramid		
Pyramid Security fixed core	PS	Add \$220.00 per cylinder
Pyramid Security LFIC	PCS	Add \$326.00 per cylinder
Pyramid High Security fixed core	PHS	Add \$265.00 per cylinder
Pyramid High Security LFIC	PCHS	Add \$371.00 per cylinder
Pyramid LFIC with temporary construction core ³	CTP	Add \$242.00 per cylinder
Pyramid LFIC with temporary disposable core ³	CTPD	Add \$130.00 per cylinder
Pyramid LFIC less core	CLP	Add \$130.00 per cylinder

*Optional alarm unit cylinder and trim are keyed alike unless otherwise specified. If different keying is required, specify outside cylinder, then inside cylinder.

**6P cylinder option is supplied in 6-pin, L4 keyway, 0-bitted with two nickel silver keys.

500ET Cylinder Options (Continued on next page)		
Description	Specify Quick Code	Add or Deduct
Conventional 6-pin	(standard)	No Charge
Conventional 7-pin	7P	Add \$2.00 per cylinder
Less Cylinder(s)	LC	Deduct \$120.00 per cylinder
LFIC		
LFIC 6-pin	C6	Add \$112.00 per cylinder
LFIC 6-pin Less Core ¹	CL6	No Charge
LFIC 6-pin with Temporary Construction Core (Red) ¹	CT6R	Add \$112.00 per cylinder
LFIC 6-pin with Temporary Construction Core (Blue) ¹	CT6B	Add \$112.00 per cylinder
LFIC 6-pin with Temporary Construction Core (Green) ¹	CT6G	Add \$112.00 per cylinder
LFIC 6-Pin Disposable Core ¹	CT6D	No Charge
LFIC 7-pin	C7	Add \$114.00 per cylinder
LFIC 7-pin Less Core ¹	CL7	No Charge
LFIC 7-pin with Temporary Construction Core (Red) ¹	CT7R	Add \$114.00 per cylinder
LFIC 7-pin with Temporary Construction Core (Blue) ¹	CT7B	Add \$114.00 per cylinder
LFIC 7-pin with Temporary Construction Core (Green) ¹	CT7G	Add \$114.00 per cylinder
LFIC 7-Pin Disposable Core ¹	CT7D	No Charge

500ET Cylinder Options (Continued)		
Description	Specify Quick Code	Add or Deduct
SFIC (all lever designs)¹		
SFIC 6-pin	C6S	Add \$101.00 per cylinder
SFIC 6-pin with Temporary Construction Core (Blue)	CT6SB	Add \$101.00 per cylinder
SFIC 6-pin or 7-pin Temporary Disposable core	CTSD	No Charge
SFIC 7-pin ¹	C7S	Add \$101.00 per cylinder
SFIC 7-pin with Temporary Construction Core (Blue)	CT7SB	Add \$101.00 per cylinder
Security		
Security ¹	HS	Add \$167.00 per cylinder
Security LFIC ¹	CHS	Add \$279.00 per cylinder
Access 3		
Access 3 [®] Patented Fixed Core	AP	No Charge
Access 3 [®] Security Fixed Core	AS	Add \$84.00 per cylinder
Access 3 [®] High Security Fixed Core	AHS	Add \$120.00 per cylinder
Access 3 [®] Patented LFIC ¹	ACP	Add \$112.00 per cylinder
Access 3 [®] Security LFIC ¹	ACS	Add \$196.00 per cylinder
Access 3 [®] High Security LFIC ¹	ACHS	Add \$232.00 per cylinder
Pyramid		
Pyramid Security Fixed Core ¹	PS	Add \$90.00 per cylinder
Pyramid Security LFIC ¹	PCS	Add \$196.00 per cylinder
Pyramid High Security Fixed Core ¹	PHS	Add \$131.00 per cylinder
Pyramid High Security LFIC ¹	PCHS	Add \$241.00 per cylinder
Pyramid with Temporary Construction Core ¹	CTP	Add \$112.00 per cylinder
Pyramid Disposable Core ¹	CTPD	No Charge
Pyramid LFIC Less Core ¹	CLP	No Charge
Other		
Lockset furnished in Schlage [®] C Keyway	C	No Charge
Lockset furnished in Sargent [®] LA Keyway	LA	No Charge

Notes: 1. Not available in CLX3329 function

Cylinder Options & Keying Options**				
Description	Specify Quick Code		Add or Deduct	
Keying and Keys				
0-bitted with 2 Blank Keys	(standard)		No Charge	
Keyed Random	KR			
Construction Master Keyed ²	CMK		Add \$16.00 per cylinder	
More than 2 Keys	KY# (e.g., KY6)		See page 33 - Cut Keys Section	
Master Keying				
Master keyed (all cylinders except CR8000, CR8020, CR8027, CR8200, CR8500, CR8600, CR8700)	MK		Add \$16.00 per cylinder	
Master keyed Pyramid (except CR8020, CR8027 LFIC cores)	MK			
Master keyed Security (including LFIC cylinder and core)	MK			
Master keyed Access 3 (except CR8500, CR8600, CR8700 LFIC cores)	MK		No Charge	
Master keyed (CR8000, CR8020, CR8027, CR8200, CR8500, CR8600, CR8700)	MK-IC			
Master keyed to customer bittings or sample key	MK-CB		Add \$16.00 per cylinder	
Visual Cylinder/Key Control (VKC)	Cylinders		Keys	
	Stamping	List Price	Stamping	List Price
VKC0 – No stamping except keyway designation (keys will be tagged)	No Stamping	No Charge	No Stamping	\$5/key
VKC1 – Keys only	N/A	N/A	Keyset	No Charge
VKC2 – Cylinder and keys*	Keyset	\$4/cyl	Keyset	No Charge
VKC3 – Cylinder*	Keyset	\$4/cyl	Bittings	No Charge
All VKC, VDC, or VAC stamping codes that use an alternate symbol	Alternate Stamping	\$4/cyl	Alternate Stamping	\$4/cyl
Concealed Cylinder/Visual Key Control (CKC)	Cylinders		Keys	
	Stamping	List Price	Stamping	List Price
CKC2 – Cylinder and Keys*	Keyset	\$4/cyl	Keyset	No Charge
CKC3 – Cylinders only*	Keyset	\$4/cyl	Bittings	No Charge
All CKC, CDC, or CAC stamping codes that use an alternate symbol	Alternate Stamping	\$4/cyl	Alternate Stamping	\$4/cyl

*Cylinder face stamping not available for Access 3, Pyramid, or Security products

Notes: 1. CMK Construction master keying charge is in addition to master keying charge.

2. CMK construction master keying is not available in interchangeable core, Access 3, Pyramid, or Security series.

**For key bows other than 10 and 90, specify 'KB' + bow number as Quick Code, e.g. KB12. No extra charge.

Door Width Options

Door Width	Specify	Add or Deduct
36"	(standard)	No Charge
42"	W042	
48"	W048	

Door Thickness Options

Door Thickness	Specify	Add or Deduct
1-3/4"	(standard)	No Charge
2"	D200	
2-1/4"	D214	

Door Height Options

Door Height	Specify	Add or Deduct
7'0" (ED2400 devices)	(standard)	No Charge
7'2"	H0702	
7'6"	H0706	
8'0" (ED2400A devices)	H0800	

Miscellaneous Options

Description	Specify	Add or Deduct
Bottom Pullman Latch	BPL	Add \$47.00 per device
Lever to accept 6- or 7-pin Best-type IC core (SFIC) – (N5, PR5 design only)	M08	No Charge
Lever to accept Sargent® cylinder – (N5, PR5 design only)	M09	
Trim Lever to accept <i>Schlage</i> IC core – (N5, PR5 design only)	M69	
Less dogging	M51	
Sex nuts and bolts (SNBs)	M54	Add \$73.00 per mullion
Mullion Stabilizer	M57	
Shim kit (for vision light)		
- Rim device	M58	Add \$87.00 per device
- Vertical Rod device	M58	Add \$156.00 per device

Strike Options*

Description	Specify	Add or Deduct
Rim strike on ED2200 device	(standard)	No Charge
Fire rated Rim strike on ED2200A devices		
Rim x Vertical Rod strike for pairs of doors	S02	Add \$54.00 per device
Vertical Rod top strike on ED2400 device	(standard)	No Charge
Vertical Rod surface projecting bottom strike on ED2400 device		
Vertical Rod flush bottom strike on ED2400 device	S09	No Charge
Fire rated Vertical Rod top strike on ED2400A device	(standard)	No Charge
Fire rated Vertical Rod bottom strike on ED2400A device	(standard)	No Charge

*To purchase strike separately, see catalog or parts manual for part no.

Removable Mullion (Cylinder not included)

Cylinder not included

Ordering Example

Quantity	Mullion Number
10	CR972

Door Height Options

Door Height	Specify	Price
Up to 7'2", Steel Mullion – Panic Rated	CR972	\$1,030.00
Up to 7'2", Steel Mullion – 3 Hour Fire Rated	CR972A	\$1,432.00
Up to 10'0", Steel Mullion – 3 Hour Fire Rated up to 8'	CR910A	\$1,442.00
Up to 8' Split Mullion – Removable – Steel – Panic Rated	CR908SM	\$1,201.00
Up to 8' Split Mullion – Lockable – Steel – Panic Rated	CR908KMSM	\$1,774.00

Options

Description	Specify	Price
Up to 7'2", key removable mullion, 1-1/2 Hour Fire Rated	CR972BKM'	\$2,204.00
Up to 10'0", key removable mullion, 1-1/2 Hour Fire Rated up to 8'	CR910BKM'	\$2,214.00
Door frame filler block for double rabbeted frames	M95	Add \$49.00 per mullion
Door frame angle bracket for aluminum frames	M96	Add \$49.00 per mullion

Note 1: Mullion Cylinder Kit not included with Keyed Removable (KM) Mullions. Must order separately.

Mullion Cylinder Kits

Description	Specify	Price
CR972KM – Steel Mullion, Up to 7'2", Key Removable, Panic Rated	CRMCK1	\$130.00
CR972BKM – Steel Mullion, Up to 7'2", Key Removable, 1-1/2 Hour Fire Rated		
CR910BKM – Steel Mullion, Up to 10'0", Key Removable, 1-1/2 Hour Fire Rated up to 8'		
CR908KMSM – Split Mullion, Up to 8', Split Mullion, Lockable, Steel, Panic Rated		

*Specify Finish and Cylinder Key Code when ordering.

Example: CRMCK1 x FINISH x CYLINDER CODE (i.e. CRMCK1 x 630 x CT6R)

Mullions Cylinder Options

Description	Specify	Add or Deduct
Conventional 6-pin	6P	Add \$130.00 per cylinder
Conventional 7-pin	7P	Add \$132.00 per cylinder
LFIC 6-pin	C6	Add \$242.00 per cylinder
LFIC 7-pin	C7	Add \$246.00 per cylinder
Pyramid High Security Fixed Core	PHS	Add \$265.00 per cylinder
Pyramid Security Fixed Core	PS	Add \$220.00 per cylinder
Pyramid High Security IC	PCHS	Add \$371.00 per cylinder
Pyramid Security IC	PCS	Add \$326.00 per cylinder
Security	HS	Add \$301.00 per cylinder
Security IC	CHS	Add \$409.00 per cylinder
LFIC 6-pin with temporary construction core (Red)	CT6R	Add \$242.00 per cylinder
LFIC 6-pin with temporary construction core (Blue)	CT6B	Add \$242.00 per cylinder
LFIC 6-pin with temporary construction core (Green)	CT6G	Add \$242.00 per cylinder
LFIC 6-Pin with temporary disposable core	CT6D	Add \$130.00 per cylinder
LFIC 6-pin less core	CL6	Add \$130.00 per cylinder
LFIC 7-pin with temporary construction core (Red)	CT7R	Add \$246.00 per cylinder
LFIC 7-pin with temporary construction core (Blue)	CT7B	Add \$246.00 per cylinder
LFIC 7-pin with temporary construction core (Green)	CT7G	Add \$246.00 per cylinder
LFIC 7-Pin with temporary disposable core	CT7D	Add \$132.00 per cylinder
LFIC 7-pin less core	CL7	Add \$132.00 per cylinder

Standard Features

Handing

Handed, specify hand

Door Thickness

1-3/4"

Backset

2-3/4"

Projection

4" (102mm); 2 7/8" (74mm) depressed

Trim

Cylinder is not included.

See page 286 for

cylinder options.

Rim

ED3200
ED3200A

Panic
3 Hour Fire Rated

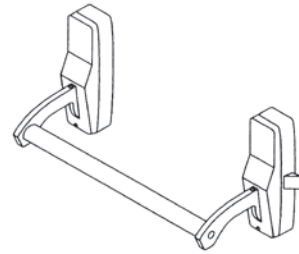

Surface Vertical Rod

ED3400 Panic
ED3400A 3 Hour Fire Rated

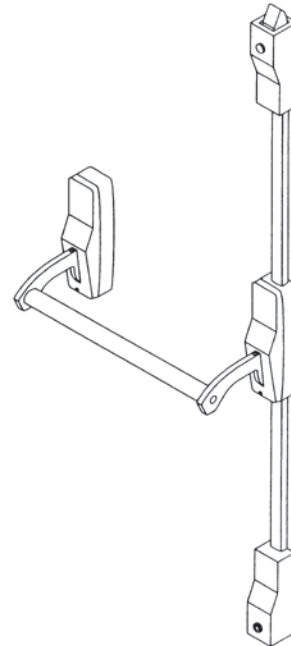

Mortise

ED3600 Panic
ED3600A 3 Hour Fire Rated

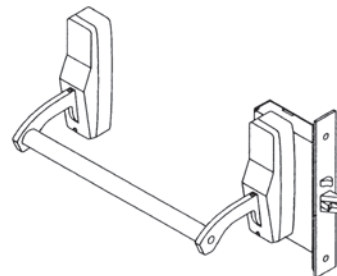

Ordering Examples

Rim Exit Device

Quantity	Exit Device	Finish	Hand	Misc. Options
20	ED3250	630	RHR	M51-M54

Rim Exit Device with Trim

Quantity	Exit Device	Trim	Finish	Hand	Door Thickness	Door Width	Misc. Options
50	ED3255A	A3355ET	630	RHR	D200	W048	M53

Trim Only (Rim Exit Device or Vertical Rod)

Quantity	Exit Device	Finish	Hand
10	L3310ET	606	RHR

Surface Vertical Rod Exit Device with Trim

Quantity	Exit Device	Trim	Finish	Hand	Door Thickness	Door Width	Misc. Options
50	ED3410	R3310ET	606	RHR	D214	W048	H1000

Mortise Exit Device with Trim

Quantity	Exit Device	Trim	Finish	Hand	Door Thickness	Strike	Door Width
50	ED3657	L3357ET	630	LHR	D200	SB200	W048

Contract/Detailed Order - Rim Exit Device with Trim

Quantity	Keypad	Exit Device	Trim	Finish	Hand	Door Thickness	Door Width	Optional Cylinders	Keying
50	AA1	ED3255	N3355ET	630	LHR	D200	W048	C6	VKC3

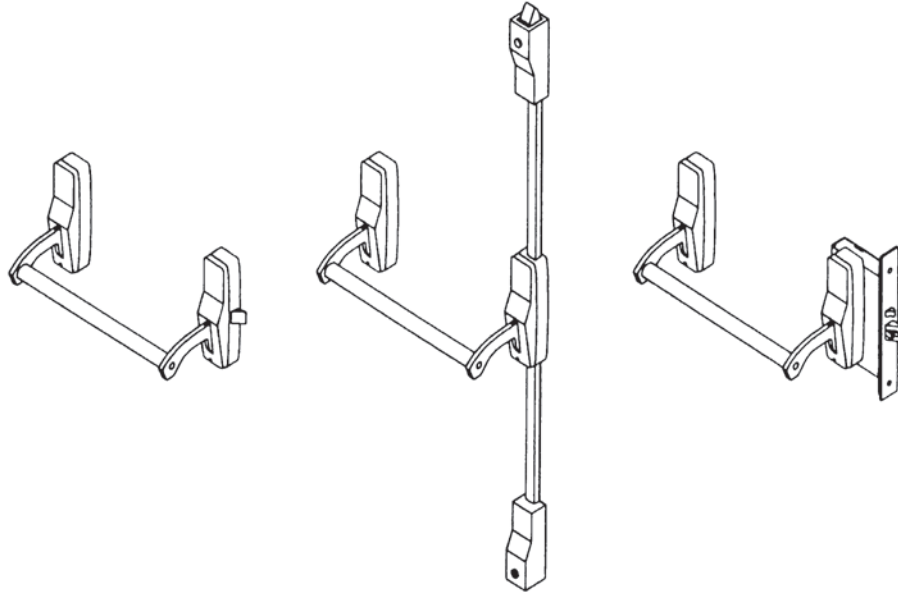

36" Device Only

Includes device, strike(s) and screw pack. No cylinder or trim.

Rim ED3200 Series

Function	Description	Finish: 613E	Finish: 605, 606, 611, 612, 613, 629, 630
ED3210	Panic device only (Passage)	\$2,855.00	\$3,025.00
ED3250	Panic device only (Dummy)		
ED3255	Panic (Classroom)		
ED3257	Panic (Nightlatch)		
ED3210T	Thumb Piece (Passage)		
ED3255T	Thumb Piece (Classroom)	\$3,104.00	\$3,274.00
ED3210A	3 Hour Fire Rated (Passage)		
ED3250A	3 Hour Fire Rated (Dummy)		
ED3255A	3 Hour Fire Rated (Classroom)		
ED3257A	3 Hour Fire Rated (Nightlatch)		
ED3210AT	Thumb Piece – 3 Hour Fire Rated (Passage)	\$3,104.00	\$3,274.00
ED3255AT	Thumb Piece – 3 Hour Fire Rated (Classroom)		

Caution: Be sure of your measurements. Exit devices are NOT returnable.

Notes:

For doors over 1-3/4" thick, a Special Application Request must be submitted to the factory prior to approval and pricing.

Surface Vertical Rod ED3400 Series			
Function	Description	Finish: 613E	Finish: 605, 606, 611, 612, 613, 629, 630
ED3410	Panic (Passage)	\$3,550.00	\$3,720.00
ED3450	Panic (Dummy)		
ED3455	Panic (Classroom)		
ED3457	Panic (Nightlatch)		
ED3410T	Thumb Piece (Passage)		
ED3455T	Thumb Piece (Classroom)		
ED3410A	3 Hour fire rated (Passage)	\$3,799.00	\$3,969.00
ED3450A	3 Hour fire rated (Dummy)		
ED3455A	3 Hour Fire Rated (Classroom)		
ED3457A	3 Hour Fire Rated (Nightlatch)		
ED3410AT	Thumb Piece – 3 Hour Fire Rated (Passage)		
ED3455AT	Thumb Piece – 3 Hour Fire Rated (Classroom)		

Mortise ED3600 Series			
Function	Description	Finish: 613E	Finish: 605, 606, 611, 612, 613, 629, 630
ED3610	Panic (Passage)	\$3,239.00	\$3,409.00
ED3650	Panic (Dummy)		
ED3655	Panic (Classroom)		
ED3657	Panic (Nightlatch)		
ED3610T	Thumb Piece (Passage)		
ED3655T	Thumb Piece (Classroom)		
ED3610A	3 Hour fire rated (Passage)		
ED3650A	3 Hour fire rated (Dummy)		
ED3655A	3 Hour Fire Rated (Classroom)		
ED3657A	3 Hour Fire Rated (Nightlatch)		
ED3610AT	Thumb Piece – 3 Hour Fire Rated (Passage)		
ED3655AT	Thumb Piece – 3 Hour Fire Rated (Classroom)		

Caution: Be sure of your measurements. Exit devices are NOT returnable.

Notes:

For doors over 1-3/4" thick, a Special Application Request must be submitted to the factory prior to approval and pricing.

ED3200/ED3200A/ED3400/ED3400A/ED3600/ED3600A Rim, Surface Vertical Rod, and Mortise Trim

Cylinder is not included.

Escutcheon Trim Design: A33 Armstrong



Lever: Cast **Escutcheon:** Cast

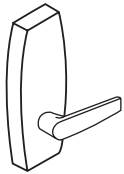

Function	Description	Finish: 605, 606, 611, 612, 613, 613E, 618, 619, 625, 626
A3310ET	Passage	\$855.00
A3350ET	Dummy	
A3355ET	Classroom	
A3357ET	Nightlatch – Rim	
A33V57ET	Nightlatch – SVR	
A33M57ET	Nightlatch – Mortise	

Escutcheon Trim Design: C33 Citation



Lever: Cast **Escutcheon:** Cast

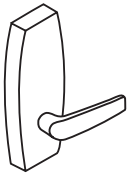

Function	Description	Finish: 605, 606, 611, 612, 613, 613E, 618, 619, 625, 626
C3310ET	Passage	\$855.00
C3350ET	Dummy	
C3355ET	Classroom	
C3357ET	Nightlatch – Rim	
C33V57ET	Nightlatch – SVR	
C33M57ET	Nightlatch – Mortise	

Escutcheon Trim Design: D33 Dirke



Lever: Cast **Escutcheon:** Cast

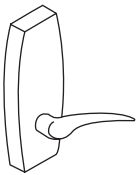

Function	Description	Finish: 605, 606, 611, 612, 613, 613E, 618, 619, 625, 626
D3310ET	Passage	\$855.00
D3350ET	Dummy	
D3355ET	Classroom	
D3357ET	Nightlatch – Rim	
D33V57ET	Nightlatch – SVR	
D33M57ET	Nightlatch – Mortise	

Escutcheon Trim Design: L33 Lustra



Lever: Cast **Escutcheon:** Cast

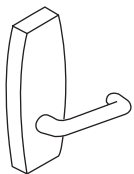

Function	Description	Finish: 605, 606, 611, 612, 613, 613E, 618, 619, 625, 626
L3310ET	Passage	\$855.00
L3350ET	Dummy	
L3355ET	Classroom	
L3357ET	Nightlatch – Rim	
L33V57ET	Nightlatch – SVR	
L33M57ET	Nightlatch – Mortise	

ED3200/ED3200A/ED3400/ED3400A/ED3600/ED3600A Rim, Surface Vertical Rod, and Mortise Trim

Cylinder is not included.

Escutcheon Trim Design: N33 Newport



Lever: Cast **Escutcheon:** Cast

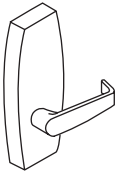

Function	Description	Finish: 605, 606, 611, 612, 613, 613E, 618, 619, 625, 626
N3310ET	Passage	\$855.00
N3350ET	Dummy	
N3355ET	Classroom	
N3357ET	Nightlatch – Rim	
N33V57ET	Nightlatch – SVR	
N33M57ET	Nightlatch – Mortise	

Escutcheon Trim Design: PR33 Princeton



Lever: Cast **Escutcheon:** Cast



Function	Description	Finish: 605, 606, 611, 612, 613, 613E, 618, 619, 625, 626
PR3310ET	Passage	\$855.00
PR3350ET	Dummy	
PR3355ET	Classroom	
PR3357ET	Nightlatch – Rim	
PR33V57ET	Nightlatch – SVR	
PR33M57ET	Nightlatch – Mortise	

Escutcheon Trim Design: R33 Regis



Lever: Cast **Escutcheon:** Cast

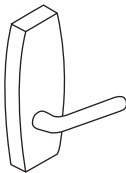

Function	Description	Finish: 605, 606, 611, 612, 613, 613E, 618, 619, 625, 626
R3310ET	Passage	\$855.00
R3350ET	Dummy	
R3355ET	Classroom	
R3357ET	Nightlatch – Rim	
R33V57ET	Nightlatch – SVR	
R33M57ET	Nightlatch – Mortise	

ED3200/ED3200A/ED3400/ED3400A/ED3600/ED3600A Rim, Surface Vertical Rod, and Mortise Trim

Cylinder is not included.

Escutcheon Trim Design: T33 D Grip

Grip: Extruded **Escutcheon:** Wrought



Function	Description	Finish: 605, 606, 611, 612, 613, 613E, 629, 630, BSP, WSP
T3310ET	Passage	\$561.00
T3350ET	Dummy	
T3355ET	Classroom	
T3357ET	Nightlatch – Rim	
T33M55ET	Classroom – Mortise	
T33M57ET	Nightlatch – Mortise	

Escutcheon Trim Design: T34 Round Grip

Grip: Extruded **Escutcheon:** Wrought



Function	Description	Finish: 605, 606, 611, 612, 613, 613E, 618, 619, BSP, WSP
T3410ET	Passage	\$561.00
T3450ET	Dummy	
T3455ET	Classroom	
T3457ET	Nightlatch – Rim	
T34M55ET	Classroom – Mortise	
T34M57ET	Nightlatch – Mortise	

Escutcheon Trim Design: T35 Sectional Grip

Grip: Extruded



Function	Description	Finish: 605, 606, 611, 612, 613, 613E, 629, 630, BSP, WSP
T3510ET	Passage	\$597.00
T3550ET	Dummy	
T3555ET	Classroom	
T3557ET	Nightlatch – Rim	
T35M55ET	Classroom – Mortise	
T35M57ET	Nightlatch – Mortise	

Auxiliary Control/Inside Lever Assembly: 3357T Nightlatch

Auxiliary Control



Function	Description	Finish: 605, 606, 611, 612, 613, 613E, 618, 619, 625, 626
3357T	Auxiliary Control/Inside Lever Assembly	\$1,030.00

Inside Lever Assembly



Offset Pull Trim: P12, P13, P14		
Offset Pull Trim	Part Number	Finish: 605, 606, 612, 613, 613E, 626, 629, 630, BSP
P12	716F50M X Finish	\$431.00
P13	716F51M X Finish	\$524.00
P14	716F52M X Finish	\$369.00

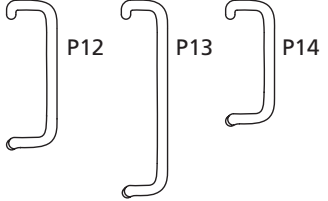

Cylinder Options*		
Description	Specify Quick Code	Add or Deduct
Conventional 6-pin	6P*	Add \$130.00 per cylinder
Conventional 7-pin	7P	Add \$132.00 per cylinder
LFIC		
LFIC 6-pin	C6	Add \$242.00 per cylinder
LFIC 6-pin less core	CL6	Add \$130.00 per cylinder
LFIC 6-pin with temporary construction core (Red)	CT6R	Add \$242.00 per cylinder
LFIC 6-pin with temporary construction core (Blue)	CT6B	Add \$242.00 per cylinder
LFIC 6-pin with temporary construction core (Green)	CT6G	Add \$242.00 per cylinder
LFIC 6-pin with temporary disposable core	CT6D	Add \$130.00 per cylinder
LFIC 7-pin	C7	Add \$246.00 per cylinder
LFIC 7-pin less core	CL7	Add \$132.00 per cylinder
LFIC 7-pin with temporary construction core (Red)	CT7R	Add \$246.00 per cylinder
LFIC 7-pin with temporary construction core (Blue)	CT7B	Add \$246.00 per cylinder
LFIC 7-pin with temporary construction core (Green)	CT7G	Add \$246.00 per cylinder
LFIC 7-pin with temporary disposable core	CT7D	Add \$132.00 per cylinder
SFIC		
SFIC 6-pin	C6S	Add \$231.00 per cylinder
SFIC 6-pin with temporary construction core (Blue)	CT6SB	Add \$231.00 per cylinder
SFIC 6-pin with SFIC disposable temporary core	CT6SD	Add \$130.00 per cylinder
SFIC 6-pin with Less Core	CLS6	Add \$130.00 per cylinder
SFIC 7-pin	C7S	Add \$231.00 per cylinder
SFIC 7-pin with temporary construction core (Blue)	CT7SB	Add \$231.00 per cylinder
SFIC 7-pin with SFIC disposable temporary core	CT7SD	Add \$130.00 per cylinder
SFIC 7-pin with Less Core	CLS7	Add \$130.00 per cylinder
Security		
Security ⁴	HS	Add \$301.00 per cylinder
Security LFIC ⁴	CHS	Add \$409.00 per cylinder
Access 3		
Access 3 Patented	AP	Add \$130.00 per cylinder
Access 3 Security	AS	Add \$214.00 per cylinder
Access 3 High Security, UL 437	AHS	Add \$250.00 per cylinder
Access 3 LFIC Patented	ACP	Add \$242.00 per cylinder
Access 3 LFIC Security	ACS	Add \$326.00 per cylinder
Access 3 LFIC High Security, UL 437	ACHS	Add \$362.00 per cylinder
Pyramid		
Pyramid Security fixed core	PS	Add \$220.00 per cylinder
Pyramid Security LFIC	PCS	Add \$326.00 per cylinder
Pyramid High Security fixed core	PHS	Add \$265.00 per cylinder
Pyramid High Security LFIC	PCHS	Add \$371.00 per cylinder
Pyramid LFIC with temporary construction core ³	CTP	Add \$242.00 per cylinder
Pyramid LFIC with temporary disposable core ³	CTPD	Add \$130.00 per cylinder
Pyramid LFIC less core	CLP	Add \$130.00 per cylinder

*6P cylinder option is supplied in 6-pin, L4 keyway 0-bitted with two nickel silver keys.

IC 6-pin with temporary construction core CT6.

IC 7-pin with temporary construction core CT7.

**Not available with Rim or SVR Lever Trim – Classroom Function.
or SVR Lever Trim – Night Latch Function.

Cylinder Options & Keying Options**				
Description	Specify Quick Code		Add or Deduct	
Keying and Keys				
0-bitted with 2 Blank Keys	(standard)		No Charge	
Keyed Random	KR			
Construction Master Keyed ²	CMK		Add \$16.00 per cylinder	
More than 2 Keys	KY# (e.g., KY6)		See page 33 - Cut Keys Section	
Master Keying				
Master keyed (all cylinders except CR8000, CR8020, CR8027, CR8200, CR8500, CR8600, CR8700)	MK		Add \$16.00 per cylinder	
Master keyed Pyramid (except CR8020, CR8027 LFIC cores)	MK			
Master keyed Security (including LFIC cylinder and core)	MK			
Master keyed Access 3 (except CR8500, CR8600, CR8700 LFIC cores)	MK			
Master keyed (CR8000, CR8020, CR8027, CR8200, CR8500, CR8600, CR8700)	MK-IC		No Charge	
Master keyed to customer bittings or sample key	MK-CB		Add \$16.00 per cylinder	
Visual Cylinder/Key Control (VKC)				
	Cylinders		Keys	
	Stamping	List Price	Stamping	List Price
VKC0 – No stamping except keyway designation (keys will be tagged)	No Stamping	No Charge	No Stamping	\$5/key
VKC1 – Keys only	N/A	N/A	Keyset	No Charge
VKC2 – Cylinder and keys*	Keyset	\$4/cyl	Keyset	No Charge
VKC3 – Cylinder*	Keyset	\$4/cyl	Bittings	No Charge
All VKC, VDC, or VAC stamping codes that use an alternate symbol	Alternate Stamping	\$4/cyl	Alternate Stamping	\$4/cyl
Concealed Cylinder/Visual Key Control (CKC)				
	Cylinders		Keys	
	Stamping	List Price	Stamping	List Price
CKC2 – Cylinder and Keys*	Keyset	\$4/cyl	Keyset	No Charge
CKC3 – Cylinders only*	Keyset	\$4/cyl	Bittings	No Charge
All CKC, CDC, or CAC stamping codes that use an alternate symbol	Alternate Stamping	\$4/cyl	Alternate Stamping	\$4/cyl
*Cylinder face stamping not available for Access 3, Pyramid, or Security products				
Notes: 1. CMK Construction master keying charge is in addition to master keying charge. 2. CMK construction master keying is not available in interchangeable core, Access 3, Pyramid, or Security series. **For key bows other than 10 and 90, specify 'KB' + bow number as Quick Code, e.g. KB12. No extra charge.				

Strike Options

To purchase strike separately see catalog for part no.

Description	Specify Quick Code	Add or Deduct
Fire rated rim strike on ED3200	(standard)	No Charge
Rim x vertical rod strike for pairs of doors	S02	Add \$54.00 per device
Vertical rod flush bottom strike (ED3400 only)	S03	No Charge
Vertical rod surface projecting bottom strike on ED3400 device	(standard)	
Fire rated vertical rod bottom strike on ED3400A device	(standard)	
Fire rated vertical rod bottom strike for threshold	S06	

Description	Door Thickness	Specify	Add or Deduct
Curved lip ANSI strike	1-3/4"	SA114 (standard)	No Charge
	2"	SA138	
	2-1/4"	SA158	

Description	Door Thickness	Specify	Add or Deduct
Mortise straight lip ANSI strike on ED3600, ED3600A	1-3/4"	SS118	No Charge
	2"	SS138	
	2-1/4"	SS158	

Description	Door Thickness	Specify	Add or Deduct
Mortise open back strike	1-3/4"	SB134	Add \$124.00 per device
	2"	SB200	\$197.00
	2-1/4"	SB214	\$197.00

Miscellaneous Options		
Description	Specify	Add or Deduct
Spanner head screws	M02	Add \$51.00 per device
Torx® screws for rim, mortise	M04	Add \$71.00 per device
Torx® screws for surface vertical rod		Add \$130.00 per device
Abrasive coat outside and inside (trim and device)	M23	Add \$135.00 per device
Abrasive coat inside only (device side)	M24	Add \$72.00 per device
Abrasive coat outside only (trim side)	M25	Add \$63.00 per device
Steel reinforced crossbar	M53	Add \$101.00 per device
Sex nuts and bolts (SNBs)	M54	No Charge
Mullion stabilizer	M57	Add \$73.00 per mullion
Shim for 2-3/4" backset on doors with 1/2" stop (rim devices only)	M59	No Charge
Flush transom bracket	M67	Add \$44.00 per device

Door Width Options		
Description	Specify	Add or Deduct
36"	(standard)	No Charge
48"	W048	Add \$53.00 per device

Door Thickness Options		
Description	Specify	Add or Deduct
1-3/4"	(standard)	No Charge
2"	D200	
2-1/4"	D214	

Door Height Options		
Description	Specify	Add or Deduct
7'0" H0700	H0700	No Charge
7'2" H0702	H0702	
7'6" H0706	H0706	
8' (Standard)	(standard)	
8'6" H0806 (ED3400 device only)	H0806	Add \$121.00 per device
9' H0900 (ED3400 device only)	H0900	
10' H01000 (ED3400 device only)	H1000	

Removable Mullion		
Description	Specify	Price
Up to 7'2" Steel Mullion - Panic Rated	CR972	\$1,030.00
Up to 7'2", Steel Mullion - 3 Hour Fire Rated	CR972A	\$1,432.00
Up to 10' (Only Fire rated up to 8'), Steel Mullion - 3 Hour Fire up to 8' size	CR910A	\$1,442.00
Up to 8' Split Mullion – Removable – Steel – Panic Rated	CR908SM	\$1,201.00

Key Removable Mullion		
Description	Specify	Price
Up to 7'2" Steel Mullion – Panic Rated	CR972KM	\$1,589.00
Up to 7'2", key removable mullion, 1-1/2 Hour Fire Rated	CR972BKM ¹	\$2,204.00
Up to 10' (only fire rated up to 8'), key removable mullion, 1-1/2 Hour Fire Rated	CR910BKM ^{1,2}	\$2,214.00
Up to 8' Split Mullion – Lockable – Steel – Panic Rated	CR908KMSM	\$1,774.00
Door frame filler block for double rabbeted frames	M95	Add \$49.00 per mullion
Door frame angle bracket for aluminum frames	M96	Add \$49.00 per mullion

Notes: 1. Mullion Cylinder Kit not included with Keyed Removable (KM) Mullions. Must order separately.
 2. Mullions longer than 8" must be ordered as fire rated option x 10' length. Fire rating is valid only up to 96".

Mullion Cylinder Kits		
Description	Specify	Price
CR972KM – Steel Mullion, Up to 7'2", Key Removable, Panic Rated	CRMCK1	\$130.00
CR972BKM – Steel Mullion, Up to 7'2", Key Removable, 1-1/2 Hour Fire Rated		
CR910BKM – Steel Mullion, Up to 10'0", Key Removable, 1-1/2 Hour Fire Rated up to 8'		
CR908KMSM – Split Mullion, Up to 8', Split Mullion, Lockable, Steel, Panic Rated		

*Specify Finish and Cylinder Key Code when ordering. Example: CRMCK1 x FINISH x CYLINDER CODE (i.e. CRMCK1 x 630 x CT6R)

Mullions Cylinder Options		
Description	Specify Quick Code	Add or Deduct
Conventional 6-pin	6P	Add \$130.00 per cylinder
Conventional 7-pin	7P	Add \$132.00 per cylinder
LFIC		
LFIC 6-pin	C6	Add \$242.00 per cylinder
LFIC 6-pin less core	CL6	Add \$130.00 per cylinder
LFIC 6-pin with temporary construction core (Red)	CT6R	Add \$242.00 per cylinder
LFIC 6-pin with temporary construction core (Blue)	CT6B	Add \$242.00 per cylinder
LFIC 6-pin with temporary construction core (Green)	CT6G	Add \$242.00 per cylinder
LFIC 6-pin with temporary disposable core	CT6D	Add \$130.00 per cylinder
LFIC 7-pin	C7**	Add \$246.00 per cylinder
LFIC 7-pin less core	CL7	Add \$132.00 per cylinder
LFIC 7-pin with temporary construction core (Red)	CT7R**	Add \$246.00 per cylinder
LFIC 7-pin with temporary construction core (Blue)	CT7B**	Add \$246.00 per cylinder
LFIC 7-pin with temporary construction core (Green)	CT7G**	Add \$246.00 per cylinder
LFIC 7-pin with temporary disposable core	CT7D**	Add \$132.00 per cylinder
Security		
Security	HS	Add \$301.00 per cylinder
Security LFIC	CHS	Add \$409.00 per cylinder
Pyramid		
Pyramid Security fixed core	PS	Add \$220.00 per cylinder
Pyramid Security LFIC	PCS	Add \$326.00 per cylinder
Pyramid High Security fixed core	PHS	Add \$265.00 per cylinder
Pyramid High Security LFIC	PCHS	Add \$371.00 per cylinder

IC 7-pin with temporary construction core CT7.

**Not available with Rim or SVR Lever Trim – Classroom Function. or SVR Lever Trim – Night Latch Function.

Mortise Lock Only

Lock Number	Description	Finish: 605, 606, 611, 612, 613, 613E, 625, 626
MLE012	Lockbody for Nightlatch/Dummy function	\$944.00
MLE013	Lockbody for Classroom function	
MLE014	Lockbody for Passage function	
MLE015	Lockbody for Passage Thumbpiece function	
MLE016	Lockbody for Classroom Thumbpiece function	

Ordering Example

Mortise Lock Only			
Quantity	Lock Number	Finish	Hand
2	MLE013	630	LHR

Standard Features

Handing

Devices are field reversible; specify hand. Lever trims are handed; specify hand

Door Thickness

1-3/4"

Door Width

36"

Projection

Standard 2.88"; 1.96" dogged
DEED 3.375"; 2.688" dogged

Trim

Cylinder is not included.
See page 302 for cylinder options

900PT Wide Trim
800PT Narrow Trim



**900PT
Wide Trim**



**800PT
Narrow Trim**

Product	Minimum Stile	
	Narrow Trim	Wide Trim
PED4200	2"	3"
PED4600	4-1/2"	4-1/2"
PED4800	1-3/4"	3"

Rim

PED4200 Panic
PED4200 A* 3 Hour Fire Rated



Mortise

PED4600 Panic
PED4600 A* 3 Hour Fire Rated



Concealed Vertical Rod

PED4800 Panic
PED4800 A* 3 Hour Fire Rated

* See Options Pages for Fire Rated Pricing

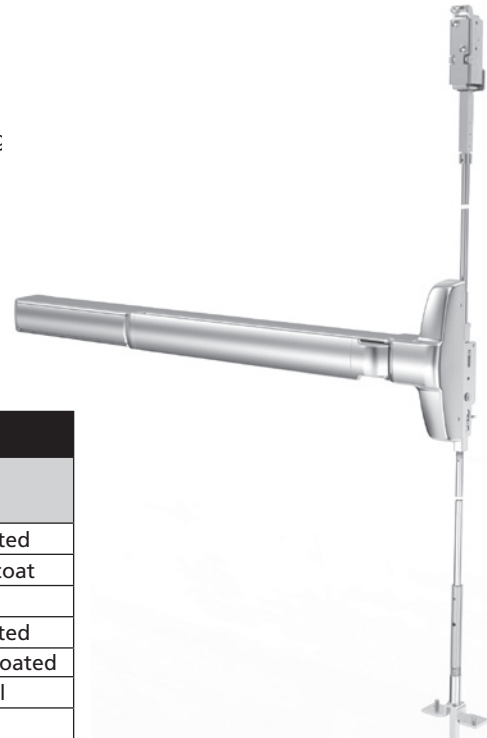

PED4000 Exit Device Mixed Finishes		
Mixed Finish Code	Rail Mount, Chassis Cover, End Cap, Dogging Scalp, Insert	Pushbar
613606	Oxidized bronze, oil rubbed	Satin brass, clear coated
630BSP	Satin stainless steel	Black suede powder coat
630ERD*	Satin stainless steel	Red powder coat
BSP606	Black suede powder coat	Satin brass, clear coated
BSP611	Black suede powder coat	Polished bronze, clear coated
BSP630	Black suede powder coat	Satin stainless steel
BSPERD*	Black suede powder coat	Red powder coat
WSPBSP	White suede powder coat	Black suede powder coat

* Available with M61 only.

Ordering Example
Exit Device Only

Quantity	Exit Device/ Function	Misc. Options	Finish	Door Thickness	Hand
20	PED4210	M51-M54	606	D134	RHR

Exit Device with Trim

Quantity	Exit Device/ Function	Misc. Options	Lever/Trim Function	Finish	Hand	Door Type	Door Thickness	Door Width	Door Height
10	PED4855	M51-M54	N9CV55PT	605	LHR	AD	D200	W048	H0706

Note: Any device is available with narrow and wide trims.

Trim Only

Quantity	Lever/Trim/ Function	Finish	Hand	Door Thickness
24	N855PT	625	RHR	D214
24	N955PT	625	RHR	D214

Contract/Detailed Order – Rim Exit Device with Trim

Quantity	Keyset	Exit Device	Misc. Options	Lever/Trim Function	Finish	Hand	Door Width	Optional Cylinder
36	AA1	PED4255	M52-M54	C955PT	626	LHR	W048	7P

Exit Device with Trim

Quantity	Exit Device/ Function	Options	Lever/Trim/ Function	Finish	Hand	Door Type	Door Thickness	Door Width	Door Height
10	PED4855	A	N9CV55PT	605	LHR	AD	D200	W048	H0706

PED4200 Series – Rim Device

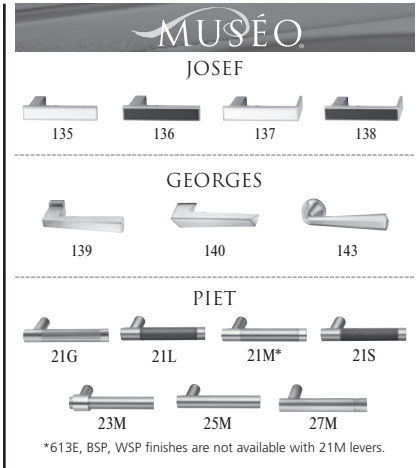
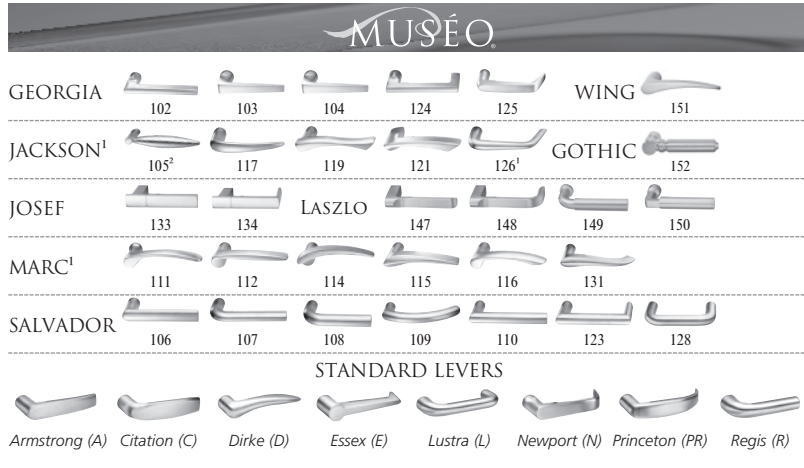

PED4200 Rim – Device Only			Standard Levers & Muséo (Except Josef, Georges & Piet)			Muséo (Josef, Georges & Piet)		
Exit Device/ Function	Trim	Description	613E, 630, BSP, WSP	605, 606, 611, 612, 613, 613L, 629 All Mixed Finishes**		613E, 630, BSP, WSP	605, 606, 611, 612, 613, 613L, 629 All Mixed Finishes**	
PED4201	No Trim	Dummy	\$3,085.00	\$3,220.00		\$3,085.00	\$3,220.00	

PED4200 Rim – 900PT Wide Trim*			Standard Levers & Muséo (Except Josef, Georges & Piet)			Muséo (Josef, Georges & Piet)		
Exit Device/ Function	900PT Wide Trim	Description	613E, 630, BSP, WSP	605, 606, 611, 612, 613, 613L, 629 All Mixed Finishes**	Trim Only	613E, 630, BSP, WSP	605, 606, 611, 612, 613, 613L, 629 All Mixed Finishes**	Trim Only
PED4210	910PT	Passage	\$4,126.00	\$4,261.00	\$1,041.00	\$4,469.00	\$4,604.00	\$1,384.00
PED4240	940PT	Dummy						
PED4245	945PT	Classroom						
PED4247	947PT	Nightlatch						
PED4249	949PT	Storeroom						
PED4250	950PT	Dummy Freewheeling						
PED4255	955PT	Classroom Freewheeling						
PED4257	957PT	Nightlatch Freewheeling						
PED4259	959PT	Storeroom Freewheeling						

Electrically Controlled Trims								
PED42910	9910PT	Fail Safe w/o Key Override	\$4,785.00	\$4,920.00	\$1,700.00	\$5,073.00	\$5,208.00	\$1,988.00
PED42930	9930PT	Fail Secure w/o Key Override						

PED4200 Rim – 800PT Narrow Trim*			Standard Levers & Muséo (Except Josef, Georges & Piet)			Muséo (Josef, Georges & Piet)		
Exit Device/ Function	800PT Narrow Trim	Description	613E, 630, BSP, WSP	605, 606, 611, 612, 613, 613L, 629 All Mixed Finishes**	Trim Only	613E, 630, BSP, WSP	605, 606, 611, 612, 613, 613L, 629 All Mixed Finishes**	Trim Only
PED4210	810PT	Passage	\$4,026.00	\$4,161.00	\$941.00	\$4,369.00	\$4,504.00	\$1,284.00
PED4240	840PT	Dummy						
PED4245	845PT	Classroom						
PED4247	847PT	Nightlatch						
PED4249	849PT	Storeroom						
PED4250	850PT	Dummy Freewheeling						
PED4255	855PT	Classroom Freewheeling						
PED4257	857PT	Nightlatch Freewheeling						
PED4259	859PT	Storeroom Freewheeling						

Electrically Controlled Trims								
PED42910	8910PT	Fail Safe w/o Key Override	\$4,685.00	\$4,820.00	\$1,600.00	\$4,973.00	\$5,108.00	\$1,888.00
PED42930	8930PT	Fail Secure w/o Key Override						

* Cylinder not included.
 **Listed finishes are for the Exit Device. Refer to catalog for available trims, trim finishes, device mixed finishes and how to order.
 1. Handed: specify hand when ordering.
 2. Contact factory for current lead time.

PED4200 Series – Rim Device



T33 Pull Trim

PED4200 Rim – T33 Pull Trim					
Exit Device/ Function	Trim	Description	Finish: 613E, 630, BSP, WSP	605, 606, 611, 612, 613, 613L, 629 All Mixed Finishes**	Trim Only
PED4250T	T3301ET	Blank Plate with Screw Holes	\$3,510.00	\$3,645.00	\$425.00
PED4250T	T3350ET	Dummy	\$3,646.00	\$3,781.00	\$561.00
PED4257T	T3357ET	Nightlatch			



T34 Pull Trim

PED4200 Rim – T34 Pull Trim					
Exit Device/ Function	Trim	Description	Finish: 613E, 630, BSP, WSP	605, 606, 611, 612, 613, 613L, 629 All Mixed Finishes**	Trim Only
PED4250T	T3450ET	Dummy	\$3,646.00	\$3,781.00	\$561.00
PED4257T	T3457ET	Nightlatch			



T35 Pull Trim

PED4200 Rim – T35 Pull Trim					
Exit Device/ Function	Trim	Description	Finish: 613E, 630, BSP, WSP	605, 606, 611, 612, 613, 613L, 629 All Mixed Finishes**	Trim Only
PED4250T	T3550ET	Dummy	\$3,682.00	\$3,817.00	\$597.00
PED4257T	T3557ET	Nightlatch			



T36 Pull Trim

PED4200 Rim – T36 Pull Trim					
Exit Device/ Function	Trim	Description	Finish: 613E, 630, BSP, WSP	605, 606, 611, 612, 613, 613L, 629 All Mixed Finishes**	Trim Only
PED4250T	T3650ET	Dummy	\$3,646.00	\$3,781.00	\$561.00
PED4257T	T3657ET	Nightlatch			



T37 Pull Trim

PED4200 Rim – T37 Pull Trim					
Exit Device/ Function	Trim	Description	Finish: 613E, 630, BSP, WSP	605, 606, 611, 612, 613, 613L, 629 All Mixed Finishes**	Trim Only
PED4250T	T3750ET	Dummy	\$3,646.00	\$3,781.00	\$561.00
PED4257T	T3757ET	Nightlatch			

**Listed finishes are for the Exit Device. Refer to catalog for available trims, trim finishes, device mixed finishes and how to order.

PED4200 Series – Rim Device Options

Electrified Options for Exit Devices

Description	Specify	Add or Deduct
Delayed Egress (Ex: PED4200 D)	D	Add \$2873.00
Exit Alarm Device (cylinder is not included)	M61	Add \$828.00
Bolt Position Monitoring	M91	Add \$385.00
Touchbar Monitoring or Signaling/Request to Exit (REX)	M92	Add \$376.00
Double Touchbar Monitoring or Signaling/Request to Exit (REX)	M92 ERM	Add \$752.00
Outside Trim Monitoring or Signaling ¹	M93	Add \$349.00
Weather Resistant Bolt Position Monitoring ⁵	WM91	Add \$572.00
Weather Resistant Touchbar Monitoring or Signaling/Request to Exit (REX) ⁵	WM92	Add \$546.00
Weather Resistant Double Touchbar Monitoring or Signaling/Request to Exit (REX) ⁵	WM92 ERM	Add \$1092.00
Weather Resistant Outside Trim Monitoring or Signaling ⁵	WM93	Add \$520.00
Motorized Electric Latch Retraction	MELR	Add \$1341.00
Latch Retraction Override (order with MELR)	VLR	Add \$1341.00
Electric Dogging	M97	Add \$698.00
Manual Dogging with Electric Device (Order with MELR or M97)	M114	No Charge
Wire Routing (Trim) ⁴	WR	Add \$77.00

Miscellaneous Options

Description	Specify	Add or Deduct
Fire Rated Exit Device (Ex: PED4255 A)	A	Add \$249.00
Guarded Latch	GL	Add \$45.00 per device
6 Lobe Head Screws (Torx)	M04	Add \$52.00 per device
Milled Lever ³	M21	Add \$105.00 per device
Abrasive coat outside and inside (trim and device) ²	M23	Add \$199.00 per device
Abrasive coat inside only (device side)	M24	Add \$136.00 per device
Abrasive coat outside only (trim side) ²	M25	Add \$63.00 per device
Dogging Indicator	M48	Add \$104.00 per device
Photoluminescent Push	M49	Add \$510.00 per device
Less dogging	M51	No Charge
Cylinder dogging (less cylinder)	M52	Add \$72.00 per device
Through Bolts	M54	Add \$35.00 per device
Overlapping End Cap	M111	No Charge
Weep Holes	WH	Add \$208.00
5lb Pressure Release	5CH	Add \$40.00 per device
Clear Lacquer Coat for 626 or 630 Finish ⁵	626LF / 630LF	Add \$315.00

1. M93 only available with PED4210, PED4245, PED4249, PED42910 & PED42930.
2. Not available with Muséo levers.
3. M21 not available with PED4201, PED4250T, PED4257T.
4. WR option standard with PED42910 & PED42930. Otherwise only available with PED4210, PED4245 & PED4249.
5. When WM91, WM92, WM92 ERM and/or WM93 are ordered with 626 or 630 finish, Clear Lacquer Coat is required (626LF or 630LF). List add applies.

PED4600 Series – Mortise Device

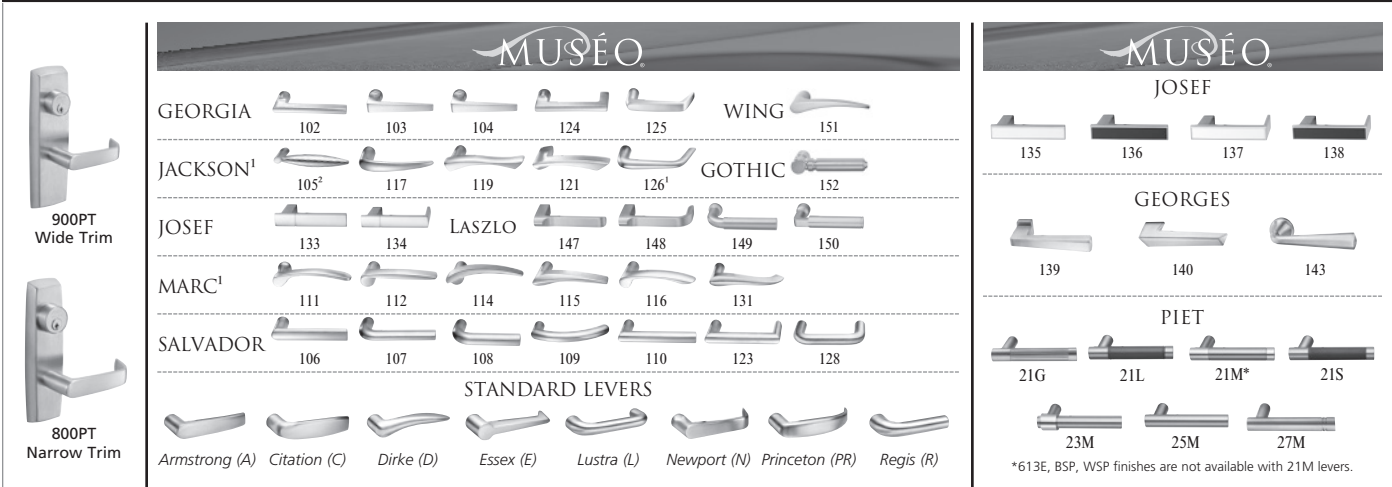

PED4600 Mortise – Device Only			Standard Levers & Muséo (Except Josef, Georges & Piet)			Muséo (Josef, Georges & Piet)		
Exit Device/ Function	Trim	Description	613E, 630, BSP, WSP	605, 606, 611, 612, 613, 613L, 629 All Mixed Finishes**		613E, 630, BSP, WSP	605, 606, 611, 612, 613, 613L, 629 All Mixed Finishes**	
PED4601	No Trim	Dummy	\$3,905.00	\$4,125.00		\$3,905.00	\$4,125.00	

PED4600 Mortise – 900PT Wide Trim*			Standard Levers & Muséo (Except Josef, Georges & Piet)			Muséo (Josef, Georges & Piet)		
Exit Device/ Function	900PT Wide Trim	Description	613E, 630, BSP, WSP	605, 606, 611, 612, 613, 613L, 629 All Mixed Finishes**	Trim Only	613E, 630, BSP, WSP	605, 606, 611, 612, 613, 613L, 629 All Mixed Finishes**	Trim Only
PED4610	9M10PT	Passage	\$4,946.00	\$5,166.00	\$1,041.00	\$5,289.00	\$5,509.00	\$1,384.00
PED4640	9M40PT	Dummy						
PED4645	9M45PT	Classroom						
PED4647	9M47PT	Nightlatch						
PED4650	9M50PT	Dummy Freewheeling						
PED4655	9M55PT	Classroom Freewheeling						
PED4657	9M57PT	Nightlatch Freewheeling						

Electrically Controlled Trims								
PED46903	9M903PT	Fail Safe w/ Key Override	\$5,858.00	\$6,078.00	\$1,953.00	\$6,131.00	\$6,351.00	\$2,226.00
PED46905	9M905PT	Fail Secure w/ Key Override						
PED46910	9M910PT	Fail Safe w/o Key Override						
PED46930	9M930PT	Fail Secure w/o Key Override	\$5,605.00	\$5,825.00	\$1,700.00	\$5,893.00	\$6,113.00	\$1,988.00

PED4600 Mortise – 800PT Narrow Trim*			Standard Levers & Muséo (Except Josef, Georges & Piet)			Muséo (Josef, Georges & Piet)		
Exit Device/ Function	800PT Narrow Trim	Description	613E, 630, BSP, WSP	605, 606, 611, 612, 613, 613L, 629 All Mixed Finishes**	Trim Only	613E, 630, BSP, WSP	605, 606, 611, 612, 613, 613L, 629 All Mixed Finishes**	Trim Only
PED4610	8M10PT	Passage	\$4,846.00	\$5,066.00	\$941.00	\$5,189.00	\$5,409.00	\$1,284.00
PED4640	8M40PT	Dummy						
PED4645	8M45PT	Classroom						
PED4647	8M47PT	Nightlatch						
PED4650	8M50PT	Dummy Freewheeling						
PED4655	8M55PT	Classroom Freewheeling						
PED4657	8M57PT	Nightlatch Freewheeling						

Electrically Controlled Trims								
PED46903	8M903PT	Fail Safe w/ Key Override	\$5,758.00	\$5,978.00	\$1,853.00	\$6,031.00	\$6,251.00	\$2,126.00
PED46905	8M905PT	Fail Secure w/ Key Override						
PED46910	8M910PT	Fail Safe w/o Key Override						
PED46930	8M930PT	Fail Secure w/o Key Override	\$5,505.00	\$5,725.00	\$1,600.00	\$5,793.00	\$6,013.00	\$1,888.00

* Cylinder not included.
 **Listed finishes are for the Exit Device. Refer to catalog for available trims, trim finishes, device mixed finishes and how to order.
 1. Handed: specify hand when ordering.
 2. Contact factory for current lead time.

PED4600 Series – Mortise Device



T33 Pull Trim

PED4600 Mortise – T33 Pull Trim					
Exit Device/ Function	Trim	Description	Finish: 613E, 630, BSP, WSP	605, 606, 611, 612, 613, 613L, 629 All Mixed Finishes**	Trim Only
PED4650T	T3301ET	Blank Plate with Screw Holes	\$4,330.00	\$4,550.00	\$425.00
PED4610T	T3310ET	Passage	\$4,466.00	\$4,686.00	\$561.00
PED4650T	T3350ET	Dummy			
PED4655T	T33M55ET	Classroom			
PED4657T	T33M57ET	Nightlatch			



T34 Pull Trim

PED4600 Mortise – T34 Pull Trim					
Exit Device/ Function	Trim	Description	Finish: 613E, 630, BSP, WSP	605, 606, 611, 612, 613, 613L, 629 All Mixed Finishes**	Trim Only
PED4610T	T3410ET	Passage	\$4,466.00	\$4,686.00	\$561.00
PED4650T	T3450ET	Dummy			
PED4655T	T34M55ET	Classroom			
PED4657T	T34M57ET	Nightlatch			



T35 Pull Trim

PED4600 Mortise – T35 Pull Trim					
Exit Device/ Function	Trim	Description	Finish: 613E, 630, BSP, WSP	605, 606, 611, 612, 613, 613L, 629 All Mixed Finishes**	Trim Only
PED4610T	T3510ET	Passage	\$4,502.00	\$4,722.00	\$597.00
PED4650T	T3550ET	Dummy			
PED4655T	T35M55ET	Classroom			
PED4657T	T35M57ET	Nightlatch			



T36 Pull Trim

PED4600 Mortise – T36 Pull Trim					
Exit Device/ Function	Trim	Description	Finish: 613E, 630, BSP, WSP	605, 606, 611, 612, 613, 613L, 629 All Mixed Finishes**	Trim Only
PED4610T	T3610ET	Passage	\$4,466.00	\$4,686.00	\$561.00
PED4650T	T3650ET	Dummy			
PED4655T	T36M55ET	Classroom			
PED4657T	T36M57ET	Nightlatch			



T37 Pull Trim

PED4600 Mortise – T37 Pull Trim					
Exit Device/ Function	Trim	Description	Finish: 613E, 630, BSP, WSP	605, 606, 611, 612, 613, 613L, 629 All Mixed Finishes**	Trim Only
PED4610T	T3710ET	Passage	\$4,466.00	\$4,686.00	\$561.00
PED4650T	T3750ET	Dummy			
PED4655T	T37M55ET	Classroom			
PED4657T	T37M57ET	Nightlatch			

**Listed finishes are for the Exit Device. Refer to catalog for available trims, trim finishes, device mixed finishes and how to order.

PED4600 Series – Mortise Device Options

Electrified Options for Exit Devices

Description	Specify	Add or Deduct
Delayed Egress (Ex: PED4655 D)	D	Add \$2873.00
Exit Alarm Device (cylinder is not included)	M61	Add \$828.00
Bolt Position Monitoring	M91	Add \$385.00
Touchbar Monitoring or Signaling/Request to Exit (REX)	M92	Add \$376.00
Double Touchbar Monitoring or Signaling/Request to Exit (REX)	M92 ERM	Add \$752.00
Outside Trim Monitoring or Signaling ¹	M93	Add \$349.00
Wire Routing (Trim) ⁴	WR	Add \$77.00
Motorized Electric Latch Retraction	MELR	Add \$1341.00
Latch Retraction Override (order with MELR)	VLR	Add \$610.00
Electric Dogging	M97	Add \$698.00
Manual Dogging with Electric Device (Order with MELR or M97)	M114	No Charge

Miscellaneous Options

Description	Specify	Add or Deduct
Fire Rated Exit Device (Ex: PED4655 A)	A	Add \$249.00
6 Lobe Head Screws (Torx)	M04	Add \$67.00 per device
Milled Lever ³	M21	Add \$105.00 per device
Abrasive coat outside and inside (trim and device) ²	M23	Add \$199.00 per device
Abrasive coat inside only (device side)	M24	Add \$136.00 per device
Abrasive coat outside only (trim side) ²	M25	Add \$63.00 per device
Dogging Indicator	M48	Add \$104.00 per device
Photoluminescent Push	M49	Add \$510.00 per device
Less dogging	M51	No Charge
Cylinder dogging (less cylinder)	M52	Add \$72.00 per device
Through Bolts	M54	Add \$35.00 per device
Overlapping End Cap	M111	No Charge

1. M93 only available with PED4610, PED4645, PED46903, PED46905, PED46910 & PED46930.
2. Not available with Muséo levers.
3. M21 not available with PED4601, PED4610T, PED4650T, PED4655T & PED4657T.
4. WR option standard with PED46903, PED46905, PED46910 & PED46930. Otherwise only available with PED4610 & PED4645.

PED4800 Series – Concealed Vertical Rod Device

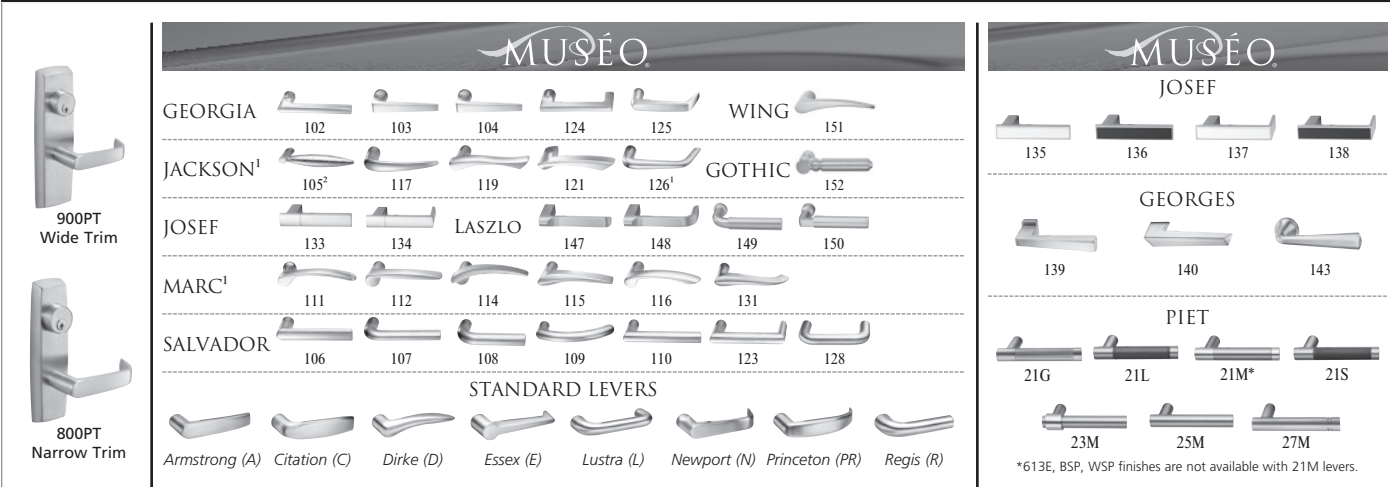

PED4800 Concealed Vertical Rod – Device Only			Standard Levers & Muséo (Except Josef, Georges & Piet)			Muséo (Josef, Georges & Piet)		
Exit Device/ Function	Trim	Description	613E, 630, BSP, WSP	605, 606, 611, 612, 613, 613L, 629 All Mixed Finishes**		613E, 630, BSP, WSP	605, 606, 611, 612, 613, 613L, 629 All Mixed Finishes**	
PED4801	No Trim	Dummy	\$4,061.00	\$4,269.00		\$4,061.00	\$4,269.00	

PED4800 Concealed Vertical Rod – 900PT Wide Trim*			Standard Levers & Muséo (Except Josef, Georges & Piet)			Muséo (Josef, Georges & Piet)		
Exit Device/ Function	900PT Wide Trim	Description	613E, 630, BSP, WSP	605, 606, 611, 612, 613, 613L, 629 All Mixed Finishes**	Trim Only	613E, 630, BSP, WSP	605, 606, 611, 612, 613, 613L, 629 All Mixed Finishes**	Trim Only
PED4810	9CV10PT	Passage	\$5,102.00	\$5,310.00	\$1,041.00	\$5,445.00	\$5,653.00	\$1,384.00
PED4840	9CV40PT	Dummy						
PED4845	9CV45PT	Classroom						
PED4849	9CV49PT	Storeroom						
PED4850	9CV50PT	Dummy Freewheeling						
PED4855	9CV55PT	Classroom Freewheeling						
PED4859	9CV59PT	Storeroom Freewheeling						

Electrically Controlled Trims								
PED48910	9CV910PT	Fail Safe w/o Key Override	\$5,761.00	\$5,969.00	\$1,700.00	\$6,049.00	\$6,257.00	\$1,988.00
PED48930	9CV930PT	Fail Secure w/o Key Override						

PED4800 Concealed Vertical Rod – 800PT Narrow Trim*			Standard Levers & Muséo (Except Josef, Georges & Piet)			Muséo (Josef, Georges & Piet)		
Exit Device/ Function	800PT Narrow Trim	Description	613E, 630, BSP, WSP	605, 606, 611, 612, 613, 613L, 629 All Mixed Finishes**	Trim Only	613E, 630, BSP, WSP	605, 606, 611, 612, 613, 613L, 629 All Mixed Finishes**	Trim Only
PED4810	8CV10PT	Passage	\$5,002.00	\$5,210.00	\$941.00	\$5,345.00	\$5,553.00	\$1,284.00
PED4840	8CV40PT	Dummy						
PED4845	8CV45PT	Classroom						
PED4849	8CV49PT	Storeroom						
PED4850	8CV50PT	Dummy Freewheeling						
PED4855	8CV55PT	Classroom Freewheeling						
PED4859	8CV59PT	Storeroom Freewheeling						

Electrically Controlled Trims								
PED48910	8CV910PT	Fail Safe w/o Key Override	\$5,661.00	\$5,869.00	\$1,600.00	\$5,949.00	\$6,157.00	\$1,888.00
PED48930	8CV930PT	Fail Secure w/o Key Override						

Notes: *Cylinder not included. **Refer to catalog for available trims, trim finishes, device mixed finishes and how to order.
 **Listed finishes are for the Exit Device. Refer to catalog for available trims, trim finishes, device mixed finishes and how to order.
 1. Handed: specify hand when ordering. 2. Contact factory for current lead time.

Exit Device Door Application (Required Selection)

Description	Specify	Add or Deduct
Aluminum Door Application	AD	No Charge
Metal Door Application	MD	No Charge

PED4800 Series – Concealed Vertical Rod Device

Electrified Options for Exit Devices

Description	Specify	Add or Deduct
Delayed Egress (Ex: PED4855 D)	D	Add \$2873.00
Exit Alarm Device (cylinder is not included)	M61	Add \$828.00
Bolt Position Monitoring	M91	Add \$385.00
Touchbar Monitoring or Signaling/Request to Exit (REX)	M92	Add \$376.00
Double Touchbar Monitoring or Signaling/Request to Exit (REX)	M92 ERM	Add \$752.00
Outside Trim Monitoring or Signaling ¹	M93	Add \$349.00
Wire Routing (Trim) ⁴	WR	Add \$77.00
Motorized Electric Latch Retraction	MELR	Add \$1341.00
Latch Retraction Override (order with MELR)	VLR	Add \$1341.00
Electric Dogging	M97	Add \$698.00
Manual Dogging with Electric Device (Order with MELR or M97)	M114	No Charge

Miscellaneous Options

Description	Specify	Add or Deduct
Fire Rated Exit Device (Ex: PED4855 A)	A	Add \$249.00
6 Lobe Head Screws (Torx)	M04	Add \$86.00 per device
Milled Lever ³	M21	Add \$105.00 per device
Abrasive coat outside and inside (trim and device) ²	M23	Add \$199.00 per device
Abrasive coat inside only (device side)	M24	Add \$136.00 per device
Abrasive coat outside only (trim side) ²	M25	Add \$63.00 per device
Dogging Indicator	M48	Add \$104.00 per device
Photoluminescent Push	M49	Add \$510.00 per device
Less dogging	M51	No Charge
Cylinder dogging (less cylinder)	M52	Add \$72.00 per device
Through Bolts	M54	Add \$35.00 per device
Less Bottom Rod	M55	No Charge
Overlapping End Cap	M111	No Charge
5lb Pressure Release	5CH	Add \$86.00 per device

1. M93 only available with PED4810, PED4845, PED4849, PED48910 & PED48930.
2. Not available with Muséo levers.
3. M21 not available with PED4801, PED4850T.
4. WR option standard with PED48910 & PED48930. Otherwise only available with PED4810, PED4845 & PED4849.

Cylinder Options*		
Description	Specify Quick Code	Add or Deduct
Conventional 6-pin	6P*	Add \$130.00 per cylinder
Conventional 7-pin	7P	Add \$132.00 per cylinder
LFIC		
LFIC 6-pin	C6	Add \$242.00 per cylinder
LFIC 6-pin less core	CL6	Add \$130.00 per cylinder
LFIC 6-pin with temporary construction core (Red)	CT6R	Add \$242.00 per cylinder
LFIC 6-pin with temporary construction core (Blue)	CT6B	Add \$242.00 per cylinder
LFIC 6-pin with temporary construction core (Green)	CT6G	Add \$242.00 per cylinder
LFIC 6-pin with temporary disposable core	CT6D	Add \$130.00 per cylinder
LFIC 7-pin	C7	Add \$246.00 per cylinder
LFIC 7-pin less core	CL7	Add \$132.00 per cylinder
LFIC 7-pin with temporary construction core (Red)	CT7R	Add \$246.00 per cylinder
LFIC 7-pin with temporary construction core (Blue)	CT7B	Add \$246.00 per cylinder
LFIC 7-pin with temporary construction core (Green)	CT7G	Add \$246.00 per cylinder
LFIC 7-pin with temporary disposable core	CT7D	Add \$132.00 per cylinder
SFIC		
SFIC 6-pin	C6S	Add \$231.00 per cylinder
SFIC 6-pin with temporary construction core (Blue)	CT6SB	Add \$231.00 per cylinder
SFIC 6-pin with SFIC disposable temporary core	CT6SD	Add \$130.00 per cylinder
SFIC 6-pin with Less Core	CLS6	Add \$130.00 per cylinder
SFIC 7-pin	C7S	Add \$231.00 per cylinder
SFIC 7-pin with temporary construction core (Blue)	CT7SB	Add \$231.00 per cylinder
SFIC 7-pin with SFIC disposable temporary core	CT7SD	Add \$130.00 per cylinder
SFIC 7-pin with Less Core	CLS7	Add \$130.00 per cylinder
Security		
Security ³	HS	Add \$301.00 per cylinder
Security LFIC ³	CHS	Add \$409.00 per cylinder
Access 3		
Access 3 Patented	AP	Add \$130.00 per cylinder
Access 3 Security	AS	Add \$214.00 per cylinder
Access 3 High Security, UL 437	AHS	Add \$250.00 per cylinder
Access 3 LFIC Patented	ACP	Add \$242.00 per cylinder
Access 3 LFIC Security	ACS	Add \$326.00 per cylinder
Access 3 LFIC High Security, UL 437	ACHS	Add \$362.00 per cylinder
Pyramid		
Pyramid Security fixed core	PS	Add \$220.00 per cylinder
Pyramid Security LFIC	PCS	Add \$326.00 per cylinder
Pyramid High Security fixed core	PHS	Add \$265.00 per cylinder
Pyramid High Security LFIC	PCHS	Add \$371.00 per cylinder
Pyramid LFIC with temporary construction core ³	CTP	Add \$242.00 per cylinder
Pyramid LFIC with temporary disposable core ³	CTPD	Add \$130.00 per cylinder
Pyramid LFIC less core	CLP	Add \$130.00 per cylinder

*For key bows other than 10 and 90, specify "KB" + bow number as Quick Code, e.g. KB12.

Notes: 1. CMK Construction master keying charge is in addition to master keying charge.

2. CMK Construction master keying is not available in interchangeable core, Access 3, Pyramid, or Security series.

*Optional dogging cylinder will be furnished with the same mechanism and keyed alike with the trim cylinder, unless otherwise specified. If different keying or cylinder type is required, specify outside (trim) first, then inside (dogging) cylinder.

**6P cylinder option is supplied in 6-pin, L4 keyway, 0-bitted with two nickel silver keys.

Cylinder Options & Keying Options*				
Description	Specify Quick Code		Add or Deduct	
Keying and Keys				
0-bitted with 2 Blank Keys	(standard)		No Charge	
Keyed Random	KR			
Construction Master Keyed ²	CMK		Add \$16.00 per cylinder	
More than 2 Keys	KY# (e.g., KY6)		See page 33 - Cut Keys Section	
Master Keying				
Master keyed (all cylinders except CR8000, CR8020, CR8027, CR8200, CR8500, CR8600, CR8700)	MK		Add \$16.00 per cylinder	
Master keyed Pyramid (except CR8020, CR8027 LFIC cores)	MK			
Master keyed Security (including LFIC cylinder and core)	MK			
Master keyed Access 3 (except CR8500, CR8600, CR8700 LFIC cores)	MK			
Master keyed (CR8000, CR8020, CR8027, CR8200, CR8500, CR8600, CR8700)	MK-IC		No Charge	
Master keyed to customer bittings or sample key	MK-CB		Add \$16.00 per cylinder	
Visual Cylinder/Key Control (VKC)	Cylinders		Keys	
	Stamping	List Price	Stamping	List Price
VKC0 – No stamping except keyway designation (keys will be tagged)	No Stamping	No Charge	No Stamping	\$5/key
VKC1 – Keys only	N/A	N/A	Keyset	No Charge
VKC2 – Cylinder and keys*	Keyset	\$4/cyl	Keyset	No Charge
VKC3 – Cylinder*	Keyset	\$4/cyl	Bittings	No Charge
All VKC, VDC, or VAC stamping codes that use an alternate symbol	Alternate Stamping	\$4/cyl	Alternate Stamping	\$4/cyl
Concealed Cylinder/Visual Key Control (CKC)	Cylinders		Keys	
	Stamping	List Price	Stamping	List Price
CKC2 – Cylinder and Keys*	Keyset	\$4/cyl	Keyset	No Charge
CKC3 – Cylinders only*	Keyset	\$4/cyl	Bittings	No Charge
All CKC, CDC, or CAC stamping codes that use an alternate symbol	Alternate Stamping	\$4/cyl	Alternate Stamping	\$4/cyl
*Cylinder face stamping not available for Access 3, Pyramid, or Security products				
Notes: 1. CMK Construction master keying charge is in addition to master keying charge. 2. CMK construction master keying is not available in interchangeable core, Access 3, Pyramid, or Security series. *For key bows other than 10 and 90, specify "KB" + bow number as Quick Code, e.g. KB12.				

Offset Pull Trim: P12, P13, P14		
Offset Pull Trim	Part Number	Finish: 605, 606, 611, 612, 613, 613E, 618, 619, 625, 626, 629, 630, 722, BSP
P12	716F50M X Finish	\$431.00
P13	716F51M X Finish	\$524.00
P14	716F52M X Finish	\$369.00

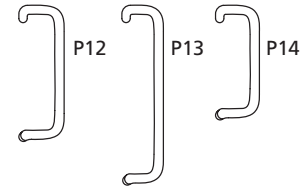

Key Only Trim: K1		
Note: Available with cylinder option only. Example K157ET x 6P. Cylinder option pricing applies.		
Aux Items	Compatible Device Functions	Finish: 605, 606, 611, 612, 613, 618, 619, 625, 626, 629, 630, BSP, WSP
K157ET	PED4247, PED4257 & PED4257T	\$88.00
K1M57ET	PED4647 & PED4657	



Auxiliary Outside Controls			
Aux Items	Description	Compatible Device Functions	Finish: 605, 606, 611, 612, 613, 618, 619, 625, 626, 629, 630, BSP, WSP
PED155	Classroom	PED48910, PED48930 & PED4850T	\$1,071.00
PED159	Storeroom		



Door Height Options – ED4800 Exit Devices		
Door Height	Specify	Add or Deduct
6'0" - 8'11-3/4"	H0600 - H08113	No Charge
9'0" - 10'0"	H0900 - H1000	Add \$86.00 per device

*Exact door height required. Reference catalog for more information.

Above Finished Floor Options – PED4800 Exit Devices		
Door Height	Specify	Add or Deduct
35" - 39-1/2"	AFF035 to AFF0394	No Charge
39-5/8" (Standard)	AFF0395 (Standard)	
39-3/4" - 48"	AFF0396 to AFF048	

*Exact above finished floor required. Reference catalog for more information.

Door Width Options		
Door Width	Specify	Add or Deduct
24" to 32"	W032	No Charge
32-1/2" to 36"	W036 (Standard)	
36-1/2" to 42"	W042	
42-1/2" to 48"	W048	

*Exact Door Width required. Reference catalog for more information.

Door Thickness Options		
Door Thickness	Specify	Add or Deduct
1-3/4"	D134 (Standard)	No Charge
2"	D200	
2-1/4"	D214	
2-3/8" to 5"	D238 up to D500*	\$468.00
2-3/8" to 5" w/ PED300		\$936.00

*Refer to catalog for available devices, trims, and auxiliary control functions.

Active Dogging Indicator Options

Description	Option	List Price
Single Indicator Inside – Unlocked/Locked – Green/Red	V01	\$368.00
Single Indicator Inside – Icons Only – Green/Red	V03	\$368.00
Single Indicator Inside – Unlocked/Locked – White/Red	V04	\$368.00
Single Indicator Inside – Icons Only – White/Red	V06	\$368.00
Inside Engraving with “Lock” and Directional Arrow (only 605,606,629,630 finishes)	EMD	\$57.00
French Indicator Option Codes		
Description	Option	List Price
Single Indicator Inside – Ouvert/Fermé – Green/Red	V01F	\$368.00

Ordering Examples:

Hex Dogging with Active Indicator:

Device Type	Function	Options	Hand	Finish	Door Width
PED52	47	V01	RHR	630	W036

Cylinder Dogging with Active Indicator (less cylinder):

Device Type	Function	Options	Hand	Finish	Door Width
PED52	47	V01 x M52	RHR	630	W036

Thumb Turn Dogging with Active Indicator:

Device Type/ Cylinder	Function	Options	Hand	Finish	Door Width	Cylinder
PED52	47	V01 x M52	RHR	630	W036	LC
CR1300-118-A07				630		

- Notes:**
- Handing must be specified.
 - M52 Cylinder dogging (less cylinder) list add applies.
 - Thumb Turn Mortise Cylinder CR1300 must be ordered separately. Exit Device must be ordered with M52 Cylinder Dogging and LC – Less Cylinder to be compatible with Thumb Turn Mortise Cylinder.
 - Not available with A, MELR, D, M97, M61, M23, M24 and M25.
 - For more information, please reference the Corbin Russwin PED4000/PED5000 Catalogs.

PED4000 Motorized Electric Latch Retraction Retrofit Kit

Kit Includes: Carrier Assembly (includes motor assembly and controller) and dogging slope plug for hex key devices.

Kit#	Rail Size	Stile	List Price	Available Options				
				M91	M92	M92 ERM	M93	5CH
PMELR	32" (W032)	Narrow (N) Wide (W)	\$2,392.00	Add \$385.00	Add \$376.00	Add \$752.00	Add \$349.00	No Charge
	36" (W036)							
	42" (W042)							
	48" (W048)							

PED4000 M92 Request to Exit Retrofit Kit

Compatible with M91 and M93 options – Kit includes the harness assembly.

Kit#	Included Option	Rail Size	Compatible Options	List Price
896F18	M92	W032/W036	M91	\$376.00
896F19		W042/W048	M91	
896F20		W032/W036	M91 M93	\$476.00
896F21		W042/W048	M91 M93	
896F22	M92 ERM	W032/W036	M91	\$564.00
896F23		W042/W048	M91	
896F24		W032/W036	M91 M93	\$664.00
896F25		W042/W048	M91 M93	

Note: The M92 retrofit harness is available with M91 and M93 option compatibility. M91 (Latchbolt Monitoring) chassis assemblies and M93 (PT Lever Monitoring) trim sold separately.

Standard Features

Handing

Devices are field reversible; specify hand.
Lever trims are handed; specify hand.

Note: Specify hand for all double cylinder exit devices

Door Thickness

1-3/4"

Door Width

36"

Projection

Standard 2.88"; 1.96" dogged
DEED 3.375"; 2.688" dogged

Trim

900PT Wide Trim
800PT Narrow Trim



**900PT
Wide Trim**



**800PT
Narrow Trim**

RIM

PED5200 Panic
PED5200 A* 3 Hour Fire Rated



Vertical Rod

PED5400 Panic
PED5400 A* 3 Hour Fire Rated



Mortise

PED5600 Panic
PED5600 A* 3 Hour Fire Rated



Concealed Vertical Rod

PED5800 Panic
PED5800 A* 3 Hour Fire Rated



* See Options pages for Fire Rated pricing.

Product	Minimum Stile	
	Narrow Trim	Wide Trim
PED5200	4-1/2"	4-1/2"
PED5400	4-1/2"	4-1/2"
	(3-1/2" without trim)	
PED5600	4-1/2"	4-1/2"
PED5800	4-1/2"	4-1/2"
	(3-1/2" without trim)	

PED5000 Exit Device Mixed Finishes

Mixed Finish Code	Rail Mount, Chassis Cover, End Cap, Dogging Scalp, Insert	Pushbar
613606	Oxidized bronze, oil rubbed	Satin brass, clear coated
630BSP	Satin stainless steel	Black suede powder coat
630ERD*	Satin stainless steel	Red powder coat
BSP606	Black suede powder coat	Satin brass, clear coated
BSP611	Black suede powder coat	Polished bronze, clear coated
BSP630	Black suede powder coat	Satin stainless steel
BSPERD*	Black suede powder coat	Red powder coat
WSPBSP	White suede powder coat	Black suede powder coat

* Available with M61 only.

Ordering Example
Exit Device Only

Quantity	Exit Device/ Function	Misc. Options	Finish	Door Thickness	Hand
20	PED5210	M51-M54	606	D134	RHR

Removable Mullions

Quantity	Mullion	Finish	Misc. Options
12	CR972	695	M57

Exit Device with Trim

Quantity	Exit Device/ Function	Misc. Options	Lever/Trim Function	Finish	Hand	Door Type	Door Thickness	Door Width	Door Height
10	PED5855	M51-M54	N9CV55PT	605	LHR	AD	D200	W048	H0706

Note: Any device is available with narrow and wide trims.

Trim Only

Quantity	Lever/Trim/ Function	Finish	Hand	Door Thickness
24	N855PT	625	RHR	D214
24	N955PT	625	RHR	D214

Contract/Detailed Order – Rim Exit Device with Trim

Quantity	Keyset	Exit Device	Misc. Options	Lever/Trim Function	Finish	Hand	Door Width	Optional Cylinder
36	AA1	PED5255	M52-M54	C955PT	626	LHR	W048	7P

Exit Device with Trim

Quantity	Exit Device/ Function	Options	Lever/Trim/ Function	Finish	Hand	Door Type	Door Thickness	Door Width	Door Height
10	PED5855	A	N9CV55PT	605	LHR	AD	D200	W048	H0706

PED5200 Series – Rim Device

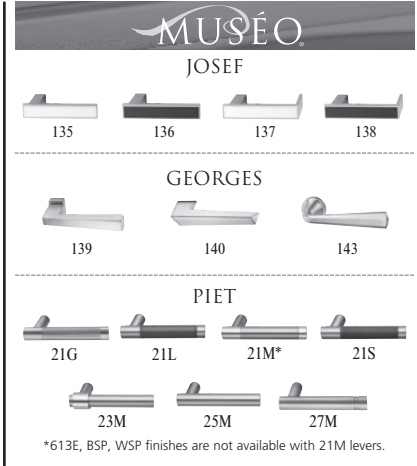
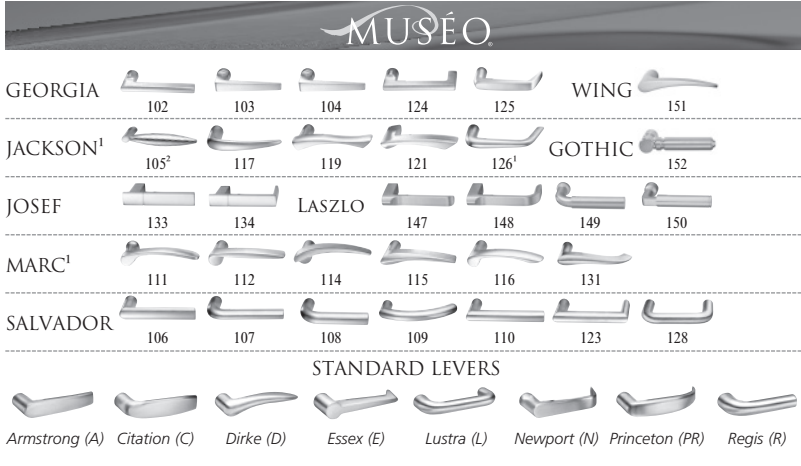

PED5200 Rim – Device Only			Standard Levers & Muséo (Except Josef, Georges & Piet)		Muséo (Josef, Georges & Piet)	
Exit Device/ Function	Trim	Description	613E, 630, BSP, WSP	605, 606, 611, 612, 613, 613L, 629 All Mixed Finishes**	613E, 630, BSP, WSP	605, 606, 611, 612, 613, 613L, 629 All Mixed Finishes**
PED5201	No Trim	Dummy	\$2,485.00	\$2,637.00	\$2,485.00	\$2,637.00

PED5200 Rim – 900PT Wide Trim*			Standard Levers & Muséo (Except Josef, Georges & Piet)			Muséo (Josef, Georges & Piet)		
Exit Device/ Function	900PT Wide Trim	Description	613E, 630, BSP, WSP	605, 606, 611, 612, 613, 613L, 629 All Mixed Finishes**	Trim Only	613E, 630, BSP, WSP	605, 606, 611, 612, 613, 613L, 629 All Mixed Finishes**	Trim Only
PED5210	910PT	Passage	\$3,526.00	\$3,678.00	\$1,041.00	\$3,869.00	\$4,021.00	\$1,384.00
PED5240	940PT	Dummy						
PED5242	942PT	Classroom Security						
PED5245	945PT	Classroom						
PED5247	947PT	Nightlatch						
PED5249	949PT	Storeroom						
PED5250	950PT	Dummy Freewheeling						
PED5255	955PT	Classroom Freewheeling						
PED5257	957PT	Nightlatch Freewheeling						
PED5259	959PT	Storeroom Freewheeling						
PED5267	967PT	Shelter	\$3,656.00	\$3,808.00	\$1,041.00	\$3,999.00	\$4,151.00	\$1,384.00

Electrically Controlled Trims			613E, 630, BSP, WSP	605, 606, 611, 612, 613, 613L, 629 All Mixed Finishes**	Trim Only	613E, 630, BSP, WSP	605, 606, 611, 612, 613, 613L, 629 All Mixed Finishes**	Trim Only
PED52903	9903PT	Fail Safe w/ Key Override	\$4,438.00	\$4,590.00	\$1,953.00	\$4,711.00	\$4,863.00	\$2,226.00
PED52905	9905PT	Fail Secure w/ Key Override						
PED52910	9910PT	Fail Safe w/o Key Override						
PED52930	9930PT	Fail Secure w/o Key Override	\$4,185.00	\$4,337.00	\$1,700.00	\$4,473.00	\$4,625.00	\$1,988.00

PED5200 Rim – 800PT Narrow Trim*			Standard Levers & Muséo (Except Josef, Georges & Piet)			Muséo (Josef, Georges & Piet)		
Exit Device/ Function	800PT Narrow Trim	Description	613E, 630, BSP, WSP	605, 606, 611, 612, 613, 613L, 629 All Mixed Finishes**	Trim Only	613E, 630, BSP, WSP	605, 606, 611, 612, 613, 613L, 629 All Mixed Finishes**	Trim Only
PED5210	810PT	Passage	\$3,426.00	\$3,578.00	\$941.00	\$3,769.00	\$3,921.00	\$1,284.00
PED5240	840PT	Dummy						
PED5242	842PT	Classroom Security						
PED5245	845PT	Classroom						
PED5247	847PT	Nightlatch						
PED5249	849PT	Storeroom						
PED5250	850PT	Dummy Freewheeling						
PED5255	855PT	Classroom Freewheeling						
PED5257	857PT	Nightlatch Freewheeling						
PED5259	859PT	Storeroom Freewheeling						
PED5267	867PT	Shelter	\$3,899.00	\$3,708.00	\$1,284.00	\$3,899.00	\$4,051.00	\$1,284.00

Electrically Controlled Trims			613E, 630, BSP, WSP	605, 606, 611, 612, 613, 613L, 629 All Mixed Finishes**	Trim Only	613E, 630, BSP, WSP	605, 606, 611, 612, 613, 613L, 629 All Mixed Finishes**	Trim Only
PED52903	8903PT	Fail Safe w/ Key Override	\$4,338.00	\$4,490.00	\$1,853.00	\$4,611.00	\$4,763.00	\$2,126.00
PED52905	8905PT	Fail Secure w/ Key Override						
PED52910	8910PT	Fail Safe w/o Key Override						
PED52930	8930PT	Fail Secure w/o Key Override	\$4,085.00	\$4,237.00	\$1,600.00	\$4,373.00	\$4,525.00	\$1,888.00

* Cylinder not included. **Listed finishes are for the Exit Device. Refer to catalog for available trims, trim finishes, device mixed finishes and how to order.
1. Handed: specify hand when ordering. 2. Contact factory for current lead time.

PED5200 Series – Rim Device



T33 Pull Trim

PED5200 Rim – T33 Pull Trim					
Exit Device/ Function	Trim	Description	Finish: 613E, 630, BSP, WSP	605, 606, 611, 612, 613, 613L, 629 All Mixed Finishes**	Trim Only
PED5250T	T3301ET	Blank Plate with Screw Holes	\$2,910.00	\$3,062.00	\$425.00
PED5210T	T3310ET	Passage	\$3,046.00	\$3,198.00	\$561.00
PED5242T	T3355ET	Classroom Security			
PED5250T	T3350ET	Dummy			
PED5255T	T3355ET	Classroom			
PED5257T	T3357ET	Nightlatch			



T34 Pull Trim

PED5200 Rim – T34 Pull Trim					
Exit Device/ Function	Trim	Description	Finish: 613E, 630, BSP, WSP	605, 606, 611, 612, 613, 613L, 629 All Mixed Finishes**	Trim Only
PED5210T	T3410ET	Passage	\$3,046.00	\$3,198.00	\$561.00
PED5242T	T3455ET	Classroom Security			
PED5250T	T3450ET	Dummy			
PED5255T	T3455ET	Classroom			
PED5257T	T3457ET	Nightlatch			



T35 Pull Trim

PED5200 Rim – T35 Pull Trim					
Exit Device/ Function	Trim	Description	Finish: 613E, 630, BSP, WSP	605, 606, 611, 612, 613, 613L, 629 All Mixed Finishes**	Trim Only
PED5210T	T3510ET	Passage	\$3,082.00	\$3,234.00	\$597.00
PED5242T	T3555ET	Classroom Security			
PED5250T	T3550ET	Dummy			
PED5255T	T3555ET	Classroom			
PED5257T	T3557ET	Nightlatch			



T36 Pull Trim

PED5200 Rim – T36 Pull Trim					
Exit Device/ Function	Trim	Description	Finish: 613E, 630, BSP, WSP	605, 606, 611, 612, 613, 613L, 629 All Mixed Finishes**	Trim Only
PED5210T	T3610ET	Passage	\$3,046.00	\$3,198.00	\$561.00
PED5242T	T3655ET	Classroom Security			
PED5250T	T3650ET	Dummy			
PED5255T	T3655ET	Classroom			
PED5257T	T3657ET	Nightlatch			



T37 Pull Trim

PED5200 Rim – T37 Pull Trim					
Exit Device/ Function	Trim	Description	Finish: 613E, 630, BSP, WSP	605, 606, 611, 612, 613, 613L, 629 All Mixed Finishes**	Trim Only
PED5210T	T3710ET	Passage	\$3,046.00	\$3,198.00	\$561.00
PED5242T	T3755ET	Classroom Security			
PED5250T	T3750ET	Dummy			
PED5255T	T3755ET	Classroom			
PED5257T	T3757ET	Nightlatch			

**Listed finishes are for the Exit Device. Refer to catalog for available trims, trim finishes, device mixed finishes and how to order.

PED5200 Series – Rim Device Options

Electrified Options for Exit Devices

Description	Specify	Add or Deduct
Delayed Egress (Ex: PED5255 D)	D	Add \$2873.00
Exit Alarm Device (cylinder is not included)	M61	Add \$828.00
Bolt Position Monitoring	M91	Add \$385.00
Touchbar Monitoring or Signaling/Request to Exit (REX)	M92	Add \$376.00
Double Touchbar Monitoring or Signaling/Request to Exit (REX)	M92 ERM	Add \$752.00
Outside Trim Monitoring or Signaling ¹	M93	Add \$349.00
Weather Resistant Bolt Position Monitoring ⁶	WM91	Add \$572.00
Weather Resistant Touchbar Monitoring or Signaling/Request to Exit (REX) ⁶	WM92	Add \$546.00
Weather Resistant Double Touchbar Monitoring or Signaling/Request to Exit (REX) ⁶	WM92 ERM	Add \$1092.00
Weather Resistant Outside Trim Monitoring or Signaling ⁶	WM93	Add \$520.00
Motorized Electric Latch Retraction	MELR	Add \$1341.00
Latch Retraction Override (order with MELR)	VLR	Add \$1341.00
Electric Dogging	M97	Add \$698.00
Manual Dogging with Electric Device	M114	No Charge
Wire Routing (Trim) ⁵	WR	Add \$77.00

Miscellaneous Options

Description	Specify	Add or Deduct
Fire Rated Exit Device (Ex: PED5255 A)	A	Add \$249.00
Guarded Latch	GL	Add \$45.00 per device
6 Lobe Head Screws (Torx)	M04	Add \$71.00 per device
Milled Lever ³	M21	Add \$105.00 per device
Abrasive coat outside and inside (trim and device) ²	M23	Add \$199.00 per device
Abrasive coat inside only (device side)	M24	Add \$136.00 per device
Abrasive coat outside only (trim side) ²	M25	Add \$63.00 per device
Visual Status Indicators (available with PED5242 & PED5242T only)	M47	Add \$498.00 per device
Dogging Indicator	M48	Add \$104.00 per device
Photoluminescent Push	M49	Add \$510.00 per device
Less dogging	M51	No Charge
Cylinder dogging (less cylinder)	M52	Add \$72.00 per device
Through Bolts	M54	Add \$30.00 per device
Hurricane Code ⁴	HC	Add \$108.00 per device
Windstorm Certified ⁴	M107	No Charge
Overlapping End Cap	M111	No Charge
Weep Holes	WH	Add \$208.00
5lb Pressure Release	5CH	Add \$40.00 per device
Clear Lacquer Coat for 626 or 630 Finish ⁶	626LF / 630LF	Add \$315.00

1. M93 only available with PED5210, PED5242, PED5245, PED5249, PED52903, PED52905, PED52910 & PED52930.
2. Not available with Muséo levers.
3. M21 not available with PED5201, PED5210T, PED5242T, PED5250T, PED5255T & PED5257T.
4. HC & M107 not available with PED5242, PED5210T, PED5242T & PED5255T.
5. WR option standard with PED52903, PED52905, PED52910 & PED52930. Otherwise only available with PED5210, PED5242 & PED5245.
6. When WM91, WM92, WM92 ERM and/or WM93 are ordered with 626 or 630 finish, Clear Lacquer Coat is required (626LF or 630LF). List add applies.

PED5400 Series – Surface Vertical Rod Device

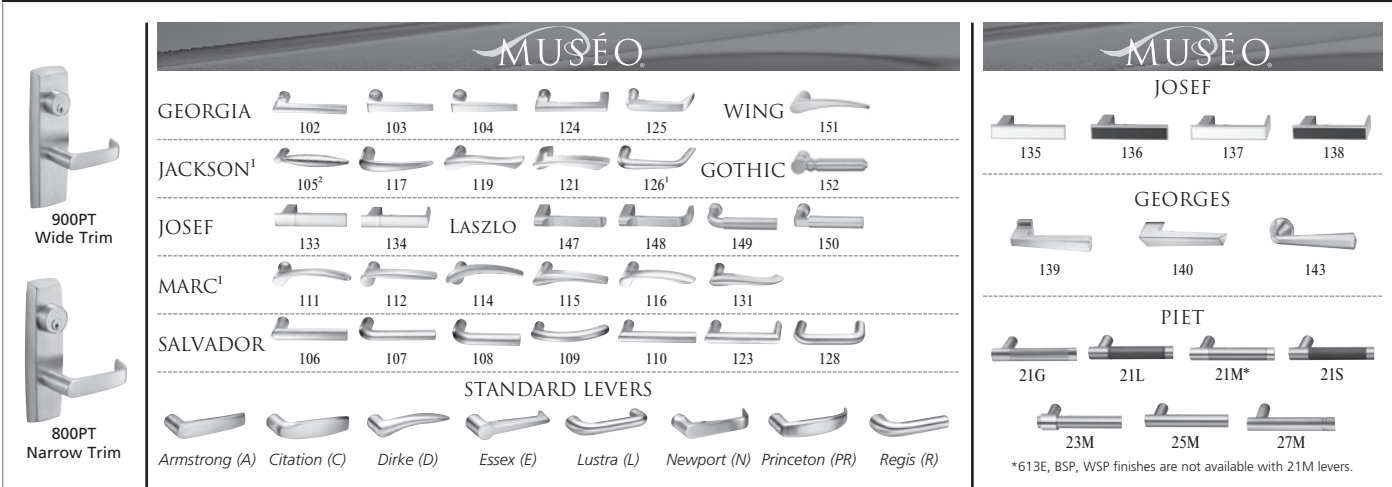

PED5400 Surface Vertical Rod – Device Only			Standard Levers & Muséo (Except Josef, Georges & Piet)			Muséo (Josef, Georges & Piet)		
Exit Device/ Function	Trim	Description	613E, 630, BSP, WSP	605, 606, 611, 612, 613, 613L, 629 All Mixed Finishes**		613E, 630, BSP, WSP	605, 606, 611, 612, 613, 613L, 629 All Mixed Finishes**	
PED5401	No Trim	Dummy	\$3,499.00	\$3,739.00		\$3,499.00	\$3,739.00	

PED5400 Surface Vertical Rod – 900PT Wide Trim*			Standard Levers & Muséo (Except Josef, Georges & Piet)			Muséo (Josef, Georges & Piet)		
Exit Device/ Function	900PT Wide Trim	Description	613E, 630, BSP, WSP	605, 606, 611, 612, 613, 613L, 629 All Mixed Finishes**	Trim Only	613E, 630, BSP, WSP	605, 606, 611, 612, 613, 613L, 629 All Mixed Finishes**	Trim Only
PED5410	9M10PT	Passage	\$4,540.00	\$4,780.00	\$1,041.00	\$4,883.00	\$5,123.00	\$1,384.00
PED5440	9M40PT	Dummy						
PED5445	9M45PT	Classroom						
PED5449	9M49PT	Storeroom						
PED5450	9M50PT	Dummy Freewheeling						
PED5455	9M55PT	Classroom Freewheeling						
PED5459	9M59PT	Storeroom Freewheeling						

Electrically Controlled Trims								
PED54910	9M910PT	Fail Safe w/o Key Override	\$5,199.00	\$5,439.00	\$1,700.00	\$5,487.00	\$5,727.00	\$1,988.00
PED54930	9M930PT	Fail Secure w/o Key Override						

PED5400 Surface Vertical Rod – 800PT Narrow Trim*			Standard Levers & Muséo (Except Josef, Georges & Piet)			Muséo (Josef, Georges & Piet)		
Exit Device/ Function	800PT Narrow Trim	Description	613E, 630, BSP, WSP	605, 606, 611, 612, 613, 613L, 629 All Mixed Finishes**	Trim Only	613E, 630, BSP, WSP	605, 606, 611, 612, 613, 613L, 629 All Mixed Finishes**	Trim Only
PED5410	8M10PT	Passage	\$4,440.00	\$4,680.00	\$941.00	\$4,783.00	\$5,023.00	\$1,284.00
PED5440	8M40PT	Dummy						
PED5445	8M45PT	Classroom						
PED5449	8M49PT	Storeroom						
PED5450	8M50PT	Dummy Freewheeling						
PED5455	8M55PT	Classroom Freewheeling						
PED5459	8M59PT	Storeroom Freewheeling						

Electrically Controlled Trims								
PED54910	8M910PT	Fail Safe w/o Key Override	\$5,099.00	\$5,339.00	\$1,600.00	\$5,387.00	\$5,627.00	\$1,888.00
PED54930	8M930PT	Fail Secure w/o Key Override						

* Cylinder not included.

**Listed finishes are for the Exit Device. Refer to catalog for available trims, trim finishes, device mixed finishes and how to order.

1. Handed: specify hand when ordering.
2. Contact factory for current lead time.

PED5400 Series – Surface Vertical Rod Device

T33 Pull Trim

PED5400 Surface Vertical Rod – T33 Pull Trim					
Exit Device/ Function	Trim	Description	Finish: 613E, 630, BSP, WSP	605, 606, 611, 612, 613, 613L, 629 All Mixed Finishes**	Trim Only
PED5450T	T3301ET	Blank Plate with Screw Holes	\$3,924.00	\$4,164.00	\$425.00
PED5410T	T3310ET	Passage	\$4,060.00	\$4,300.00	\$561.00
PED5450T	T3350ET	Dummy			
PED5455T	T33M55ET	Classroom			
PED5459T	T33M55ET	Storeroom			

T34 Pull Trim

PED5400 Surface Vertical Rod – T34 Pull Trim					
Exit Device/ Function	Trim	Description	Finish: 613E, 630, BSP, WSP	605, 606, 611, 612, 613, 613L, 629 All Mixed Finishes**	Trim Only
PED5410T	T3410ET	Passage	\$4,060.00	\$4,300.00	\$561.00
PED5450T	T3450ET	Dummy			
PED5455T	T34M55ET	Classroom			
PED5459T	T34M55ET	Storeroom			

T35 Pull Trim

PED5400 Surface Vertical Rod – T35 Pull Trim					
Exit Device/ Function	Trim	Description	Finish: 613E, 630, BSP, WSP	605, 606, 611, 612, 613, 613L, 629 All Mixed Finishes**	Trim Only
PED5410T	T3510ET	Passage	\$4,096.00	\$4,336.00	\$597.00
PED5450T	T3550ET	Dummy			
PED5455T	T35M55ET	Classroom			
PED5459T	T35M55ET	Storeroom			

T36 Pull Trim

PED5400 Surface Vertical Rod – T36 Pull Trim					
Exit Device/ Function	Trim	Description	Finish: 613E, 630, BSP, WSP	605, 606, 611, 612, 613, 613L, 629 All Mixed Finishes**	Trim Only
PED5410T	T3610ET	Passage	\$4,060.00	\$4,300.00	\$561.00
PED5450T	T3650ET	Dummy			
PED5455T	T36M55ET	Classroom			
PED5459T	T36M55ET	Storeroom			

T37 Pull Trim

PED5400 Surface Vertical Rod – T37 Pull Trim					
Exit Device/ Function	Trim	Description	Finish: 613E, 630, BSP, WSP	605, 606, 611, 612, 613, 613L, 629 All Mixed Finishes**	Trim Only
PED5410T	T3710ET	Passage	\$4,060.00	\$4,300.00	\$561.00
PED5450T	T3750ET	Dummy			
PED5455T	T37M55ET	Classroom			
PED5459T	T37M55ET	Storeroom			

**Listed finishes are for the Exit Device. Refer to catalog for available trims, trim finishes, device mixed finishes and how to order.

PED5400 Series – Surface Vertical Rod Device Options
Electrified Options for Exit Devices

Description	Specify	Add or Deduct
Delayed Egress (Ex: PED5455 D)	D	Add \$2873.00
Exit Alarm Device (cylinder is not included)	M61	Add \$828.00
Bolt Position Monitoring	M91	Add \$385.00
Touchbar Monitoring or Signaling/Request to Exit (REX)	M92	Add \$376.00
Double Touchbar Monitoring or Signaling/Request to Exit (REX)	M92 ERM	Add \$752.00
Outside Trim Monitoring or Signaling ¹	M93	Add \$349.00
Wire Routing (Trim) ⁶	WR	Add \$77.00
Motorized Electric Latch Retraction	MELR	Add \$1341.00
Latch Retraction Override (order with MELR)	VLR	Add \$1341.00
Electric Dogging	M97	Add \$698.00
Manual Dogging with Electric Device (Order with MELR)	M114	No Charge

Miscellaneous Options

Description	Specify	Add or Deduct
Fire Rated Exit Device (Ex: PED5455 A)	A	Add \$249.00
Sliding Bolt Bottom Case	M03	No Charge
6 Lobe Head Screws (Torx)	M04	Add \$130.00 per device
Milled Lever ³	M21	Add \$105.00 per device
Abrasive coat outside and inside (trim and device) ²	M23	Add \$199.00 per device
Abrasive coat inside only (device side)	M24	Add \$136.00 per device
Abrasive coat outside only (trim side) ²	M25	Add \$63.00 per device
Dogging Indicator	M48	Add \$104.00 per device
Photoluminescent Push	M49	Add \$510.00 per device
Less dogging	M51	No Charge
Cylinder dogging (less cylinder)	M52	Add \$72.00 per device
Through Bolts	M54	Add \$98.00 per device
Less Bottom Bolt & Rod ⁵	M55	No Charge
Hurricane Code ^{4,7}	HC	Add \$177.00 per device
Hurricane Resistant ^{4,7}	HC4	Add \$335.00 per device
Overlapping End Cap	M111	No Charge
5lb Pressure Release	5CH	Add \$54.00 per device

1. M93 only available with PED5410, PED5445, PED5449, PED54910 & PED54930.
2. Not available with Muséo levers.
3. M21 not available with PED5401, PED5410T, PED5450T, PED5455T & PED5459T.
4. HC, HC4 not available with PED5410T, PED5450T, PED5455T & PED5459T.
5. HC, HC4 & M55 not compatible with options D & M03.
6. WR option standard with PED54910 & PED54930. Otherwise only available with PED5410, PED5445 & PED5449.
7. HC & HC4 not compatible with M55.

PED5400 FE Series – Surface Vertical Rod Device

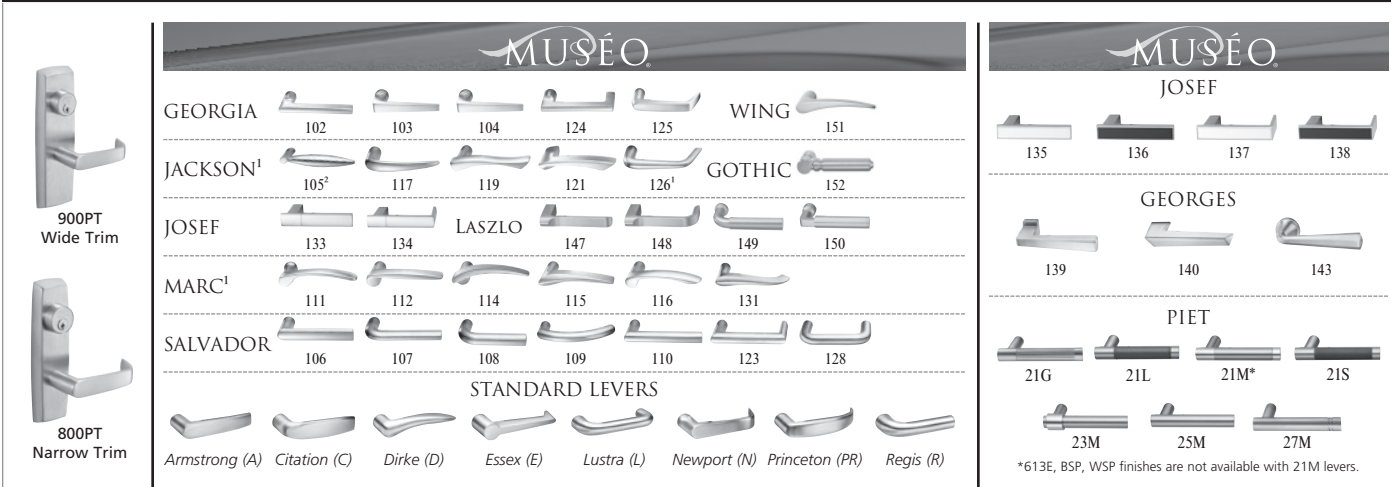

PED5400 FE Surface Vertical Rod – Device Only			Standard Levers & Muséo (Except Josef, Georges & Piet)			Muséo (Josef, Georges & Piet)		
Exit Device/ Function	Trim	Description	613E, 630, BSP, WSP	605, 606, 611, 612, 613, 613L, 629 All Mixed Finishes**		613E, 630, BSP, WSP	605, 606, 611, 612, 613, 613L, 629, All Mixed Finishes**	
PED5401 FE	No Trim	Dummy	\$4,788.00	\$5,028.00		\$4,788.00	\$5,028.00	

PED5400 FE Surface Vertical Rod – 900PT Wide Trim*			Standard Levers & Muséo (Except Josef, Georges & Piet)			Muséo (Josef, Georges & Piet)		
Exit Device/ Function	900PT Wide Trim	Description	613E, 630, BSP, WSP	605, 606, 611, 612, 613, 613L, 629 All Mixed Finishes**	Trim Only	613E, 630, BSP, WSP	605, 606, 611, 612, 613, 613L, 629 All Mixed Finishes**	Trim Only
PED5440 FE	9M40PT	Dummy	\$5,829.00	\$6,069.00	\$1,041.00	\$6,172.00	\$6,412.00	\$1,384.00
PED5445 FE	9M45PT	Classroom						
PED5449 FE	9M49PT	Storeroom						
PED5450 FE	9M50PT	Dummy Freewheeling						
PED5455 FE	9M55PT	Classroom Freewheeling						
PED5459 FE	9M59PT	Storeroom Freewheeling						

Electrically Controlled Trims								
PED54930 FE	9M930PT	Fail Secure w/o Key Override	\$6,488.00	\$6,728.00	\$1,700.00	\$6,776.00	\$7,016.00	\$1,988.00

PED5400 FE Surface Vertical Rod – 800PT Narrow Trim*			Standard Levers & Muséo (Except Josef, Georges & Piet)			Muséo (Josef, Georges & Piet)		
Exit Device/ Function	800PT Narrow Trim	Description	613E, 630, BSP, WSP	605, 606, 611, 612, 613, 613L, 629 All Mixed Finishes**	Trim Only	613E, 630, BSP, WSP	605, 606, 611, 612, 613, 613L, 629 All Mixed Finishes**	Trim Only
PED5440 FE	8M40PT	Dummy	\$5,729.00	\$5,969.00	\$941.00	\$6,072.00	\$6,312.00	\$1,284.00
PED5445 FE	8M45PT	Classroom						
PED5449 FE	8M49PT	Storeroom						
PED5450 FE	8M50PT	Dummy Freewheeling						
PED5455 FE	8M55PT	Classroom Freewheeling						
PED5459 FE	8M59PT	Storeroom Freewheeling						

Electrically Controlled Trims								
PED54930 FE	8M930PT	Fail Secure w/o Key Override	\$6,388.00	\$6,628.00	\$1,600.00	\$6,676.00	\$6,916.00	\$1,888.00

* Cylinder not included.
 **Listed finishes are for the Exit Device. Refer to catalog for available trims, trim finishes, device mixed finishes and how to order.
 1. Handed: specify hand when ordering.
 2. Contact factory for current lead time.

PED5400 FE Series – Surface Vertical Rod Device Options
Electrified Options for Exit Devices

Description	Specify	Add or Deduct
Bolt Position Monitoring	M91	Add \$385.00
Touchbar Monitoring or Signaling/Request to Exit (REX)	M92	Add \$376.00
Double Touchbar Monitoring or Signaling/Request to Exit (REX)	M92 ERM	Add \$752.00
Outside Trim Monitoring or Signaling ¹	M93	Add \$349.00
Wire Routing (Trim) ⁴	WR	Add \$77.00
Motorized Electric Latch Retraction	MELR	Add \$1341.00
Latch Retraction Override (order with MELR)	VLR	Add \$1341.00
Manual Dogging with Electric Device (Order with MELR)	M114	No Charge

Miscellaneous Options

Description	Specify	Add or Deduct
Fire Rated Exit Device (Suffix the letter D to device. Ex: PED5455 A)	A	Add \$249.00
6 Lobe Head Screws (Torx)	M04	Add \$130.00 per device
Milled Lever ³	M21	Add \$105.00 per device
Abrasive coat outside and inside (trim and device) ²	M23	Add \$199.00 per device
Abrasive coat inside only (device side)	M24	Add \$136.00 per device
Abrasive coat outside only (trim side) ²	M25	Add \$63.00 per device
Dogging Indicator	M48	Add \$104.00 per device
Photoluminescent Push	M49	Add \$510.00 per device
Less dogging	M51	No Charge
Through Bolts	M54	Add \$98.00 per device
Overlapping End Cap	M111	No Charge

1. M93 only available with PED5410, PED5445, PED5449, PED54910 & PED54930.
2. Not available with Muséo levers.
3. M21 not available with PED5401, PED5410T, PED5450T, PED5455T & PED5459T.
4. WR option standard with PED54910 & PED54930. Otherwise only available with PED5410, PED5445 & PED5449.

PED5600 Series – Mortise Device

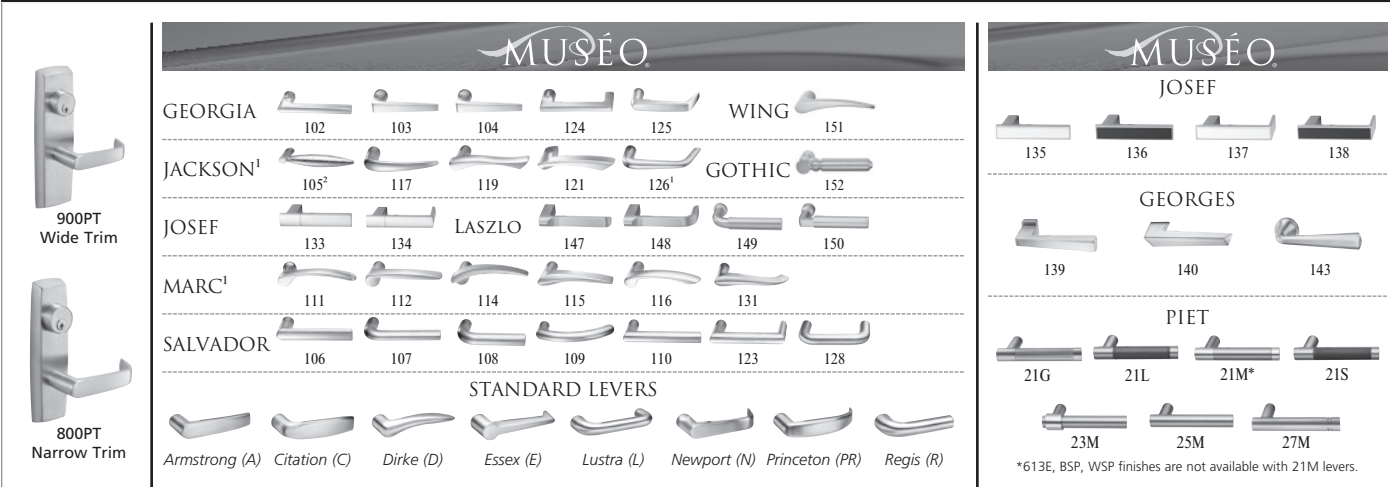

PED5600 Mortise – Device Only			Standard Levers & Muséo (Except Josef, Georges & Piet)			Muséo (Josef, Georges & Piet)		
Exit Device/ Function	Trim	Description	613E, 630, BSP, WSP	605, 606, 611, 612, 613, 613L, 629 All Mixed Finishes**		613E, 630, BSP, WSP	605, 606, 611, 612, 613, 613L, 629 All Mixed Finishes**	
PED5601	No Trim	Dummy	\$3,464.00	\$3,693.00		\$3,464.00	\$3,693.00	

PED5600 Mortise – 900PT Wide Trim*			Standard Levers & Muséo (Except Josef, Georges & Piet)			Muséo (Josef, Georges & Piet)		
Exit Device/ Function	900PT Wide Trim	Description	613E, 630, BSP, WSP	605, 606, 611, 612, 613, 613L, 629 All Mixed Finishes**	Trim Only	613E, 630, BSP, WSP	605, 606, 611, 612, 613, 613L, 629 All Mixed Finishes**	Trim Only
PED5610	9M10PT	Passage	\$4,505.00	\$4,734.00	\$1,041.00	\$4,848.00	\$5,077.00	\$1,384.00
PED5640	9M40PT	Dummy						
PED5642	9M42PT	Classroom Security						
PED5645	9M45PT	Classroom						
PED5647	9M47PT	Nightlatch						
PED5649	9M49PT	Storeroom						
PED5650	9M50PT	Dummy Freewheeling						
PED5655	9M55PT	Classroom Freewheeling						
PED5657	9M57PT	Nightlatch Freewheeling						
PED5659	9M59PT	Storeroom Freewheeling						

Electrically Controlled Trims								
PED56903	9M903PT	Fail Safe w/ Key Override	\$5,417.00	\$5,646.00	\$1,953.00	\$5,690.00	\$5,919.00	\$2,226.00
PED56905	9M905PT	Fail Secure w/ Key Override						
PED56910	9M910PT	Fail Safe w/o Key Override	\$5,164.00	\$5,393.00	\$1,700.00	\$5,452.00	\$5,681.00	\$1,988.00
PED56930	9M930PT	Fail Secure w/o Key Override						

PED5600 Mortise – 800PT Narrow Trim*			Standard Levers & Muséo (Except Josef, Georges & Piet)			Muséo (Josef, Georges & Piet)		
Exit Device/ Function	800PT Narrow Trim	Description	613E, 630, BSP, WSP	605, 606, 611, 612, 613, 613L, 629 All Mixed Finishes**	Trim Only	613E, 630, BSP, WSP	605, 606, 611, 612, 613, 613L, 629 All Mixed Finishes**	Trim Only
PED5610	8M10PT	Passage	\$4,405.00	\$4,634.00	\$941.00	\$4,748.00	\$4,977.00	\$1,284.00
PED5640	8M40PT	Dummy						
PED5642	8M42PT	Classroom Security						
PED5645	8M45PT	Classroom						
PED5647	8M47PT	Nightlatch						
PED5649	8M49PT	Storeroom						
PED5650	8M50PT	Dummy Freewheeling						
PED5655	8M55PT	Classroom Freewheeling						
PED5657	8M57PT	Nightlatch Freewheeling						
PED5659	8M59PT	Storeroom Freewheeling						

Electrically Controlled Trims								
PED56903	8M903PT	Fail Safe w/ Key Override	\$5,317.00	\$5,546.00	\$1,853.00	\$5,590.00	\$5,819.00	\$2,126.00
PED56905	8M905PT	Fail Secure w/ Key Override						
PED56910	8M910PT	Fail Safe w/o Key Override	\$5,064.00	\$5,293.00	\$1,600.00	\$5,352.00	\$5,581.00	\$1,888.00
PED56930	8M930PT	Fail Secure w/o Key Override						

* Cylinder not included.

**Listed finishes are for the Exit Device. Refer to catalog for available trims, trim finishes, device mixed finishes and how to order.

1. Handed: specify hand when ordering.
2. Contact factory for current lead time.

PED5600 Series – Mortise Device



T33 Pull Trim

PED5600 Mortise – T33 Pull Trim					
Exit Device/ Function	Trim	Description	Finish: 613E, 630, BSP, WSP	605, 606, 611, 612, 613, 613L, 629 All Mixed Finishes**	Trim Only
PED5650T	T3301ET	Blank Plate with Screw Holes	\$3,889.00	\$4,118.00	\$425.00
PED5610T	T3310ET	Passage	\$4,025.00	\$4,254.00	\$561.00
PED5642T	T33M55ET	Classroom Security			
PED5650T	T3350ET	Dummy			
PED5655T	T33M55ET	Classroom			
PED5657T	T33M57ET	Nightlatch			



T34 Pull Trim

PED5600 Mortise – T34 Pull Trim					
Exit Device/ Function	Trim	Description	Finish: 613E, 630, BSP, WSP	605, 606, 611, 612, 613, 613L, 629 All Mixed Finishes**	Trim Only
PED5610T	T3410ET	Passage	\$4,025.00	\$4,254.00	\$561.00
PED5642T	T34M55ET	Classroom Security			
PED5650T	T3450ET	Dummy			
PED5655T	T34M55ET	Classroom			
PED5657T	T34M57ET	Nightlatch			



T35 Pull Trim

PED5600 Mortise – T35 Pull Trim					
Exit Device/ Function	Trim	Description	Finish: 613E, 630, BSP, WSP	605, 606, 611, 612, 613, 613L, 629 All Mixed Finishes**	Trim Only
PED5610T	T3510ET	Passage	\$4,061.00	\$4,290.00	\$597.00
PED5642T	T35M55ET	Classroom Security			
PED5650T	T3550ET	Dummy			
PED5655T	T35M55ET	Classroom			
PED5657T	T35M57ET	Nightlatch			



T36 Pull Trim

PED5600 Mortise – T36 Pull Trim					
Exit Device/ Function	Trim	Description	Finish: 613E, 630, BSP, WSP	605, 606, 611, 612, 613, 613L, 629 All Mixed Finishes**	Trim Only
PED5610T	T3610ET	Passage	\$4,025.00	\$4,254.00	\$561.00
PED5642T	T36M55ET	Classroom Security			
PED5650T	T3650ET	Dummy			
PED5655T	T36M55ET	Classroom			
PED5657T	T36M57ET	Nightlatch			



T37 Pull Trim

PED5600 Mortise – T37 Pull Trim					
Exit Device/ Function	Trim	Description	Finish: 613E, 630, BSP, WSP	605, 606, 611, 612, 613, 613L, 629 All Mixed Finishes**	Trim Only
PED5610T	T3710ET	Passage	\$4,025.00	\$4,254.00	\$561.00
PED5642T	T37M55ET	Classroom Security			
PED5650T	T3750ET	Dummy			
PED5655T	T37M55ET	Classroom			
PED5657T	T37M57ET	Nightlatch			

**Listed finishes are for the Exit Device. Refer to catalog for available trims, trim finishes, device mixed finishes and how to order.

PED5600 Series – Mortise Device Options

Electrified Options for Exit Devices

Description	Specify	Add or Deduct
Delayed Egress (Ex: PED5655 D)	D	Add \$2873.00
Exit Alarm Device (cylinder is not included)	M61	Add \$828.00
Bolt Position Monitoring	M91	Add \$385.00
Touchbar Monitoring or Signaling/Request to Exit (REX)	M92	Add \$376.00
Double Touchbar Monitoring or Signaling/Request to Exit (REX)	M92 ERM	Add \$752.00
Outside Trim Monitoring or Signaling ¹	M93	Add \$349.00
Wire Routing (Trim) ⁵	WR	Add \$77.00
Motorized Electric Latch Retraction	MELR	Add \$1341.00
Latch Retraction Override (order with MELR)	VLR	Add \$1341.00
Electric Dogging	M97	Add \$698.00
Manual Dogging with Electric Device (Order with MELR or M97)	M114	No Charge

Miscellaneous Options

Description	Specify	Add or Deduct
Fire Rated Exit Device (Ex: PED5655 A)	A	Add \$249.00
6 Lobe Head Screws (Torx)	M04	Add \$76.00 per device
Milled Lever ³	M21	Add \$105.00 per device
Abrasive coat outside and inside (trim and device) ²	M23	Add \$199.00 per device
Abrasive coat inside only (device side)	M24	Add \$136.00 per device
Abrasive coat outside only (trim side) ²	M25	Add \$63.00 per device
Dogging Indicator	M48	Add \$104.00 per device
Photoluminescent Push	M49	Add \$510.00 per device
Less dogging	M51	No Charge
Cylinder dogging (less cylinder)	M52	Add \$72.00 per device
Through Bolts	M54	Add \$30.00 per device
Windstorm Certified ⁴	M107	No Charge
Overlapping End Cap	M111	No Charge
5lb Pressure Release	5CH	Add \$54.00 per device

1. M93 only available with PED5610, PED5642, PED5645, PED5649, PED56903, PED56905, PED56910 & PED56930.
2. Not available with Muséo levers.
3. M21 not available with PED5601, PED5610T, PED5642T, PED5650T & PED5655T.
4. M107 not available with PED5610T, PED5642T & PED5655T.
5. WR option standard with PED56903, PED56905, PED56910 & PED56930. Otherwise only available with PED5610, PED5642, PED5645 & PED5649.

PED5800 Series – Concealed Vertical Rod Device



MUSÉO

GEORGIA 102 103 104 124 125 WING 151

JACKSON¹ 105² 117 119 121 126¹ GOTHIC 152

JOSEF 133 134 LASZLO 147 148 149 150

MARC¹ 111 112 114 115 116 131

SALVADOR 106 107 108 109 110 123 128

STANDARD LEVERS

Armstrong (A) Citation (C) Dirke (D) Essex (E) Lustra (L) Newport (N) Princeton (PR) Regis (R)

MUSÉO

JOSEF

135 136 137 138

GEORGES

139 140 143

PIET

21G 21L 21M* 21S

23M 25M 27M

*613E, BSP, WSP finishes are not available with 21M levers.

PED5800 Concealed Vertical Rod – Device Only			Standard Levers & Muséo (Except Josef, Georges & Piet)			Muséo (Josef, Georges & Piet)		
Exit Device/ Function	Trim	Description	613E, 630, BSP, WSP	605, 606, 611, 612, 613, 613L, 629 All Mixed Finishes**		613E, 630, BSP, WSP	605, 606, 611, 612, 613, 613L, 629 All Mixed Finishes**	
PED5801 PED5850T	No Trim	Dummy	\$3,870.00	\$4,083.00		\$3,870.00	\$4,083.00	

PED5800 Concealed Vertical Rod – 900PT Wide Trim*			Standard Levers & Muséo (Except Josef, Georges & Piet)			Muséo (Josef, Georges & Piet)		
Exit Device/ Function	900PT Wide Trim	Description	613E, 630, BSP, WSP	605, 606, 611, 612, 613, 613L, 629 All Mixed Finishes**	Trim Only	613E, 630, BSP, WSP	605, 606, 611, 612, 613, 613L, 629 All Mixed Finishes**	Trim Only
PED5810	9CV10PT	Passage	\$4,911.00	\$5,124.00	\$1,041.00	\$5,254.00	\$5,467.00	\$1,384.00
PED5840	9CV40PT	Dummy						
PED5845	9CV45PT	Classroom						
PED5849	9CV49PT	Storeroom						
PED5850	9CV50PT	Dummy Freewheeling						
PED5855	9CV55PT	Classroom Freewheeling						
PED5859	9CV59PT	Storeroom Freewheeling						

Electrically Controlled Trims								
PED58910	9CV910PT	Fail Safe w/o Key Override	\$5,570.00	\$5,783.00	\$1,700.00	\$5,858.00	\$6,071.00	\$1,988.00
PED58930	9CV930PT	Fail Secure w/o Key Override						

PED5800 Concealed Vertical Rod – 800PT Narrow Trim*			Standard Levers & Muséo (Except Josef, Georges & Piet)			Muséo (Josef, Georges & Piet)		
Exit Device/ Function	800PT Narrow Trim	Description	613E, 630, BSP, WSP	605, 606, 611, 612, 613, 613L, 629 All Mixed Finishes**	Trim Only	613E, 630, BSP, WSP	605, 606, 611, 612, 613, 613L, 629 All Mixed Finishes**	Trim Only
PED5810	8CV10PT	Passage	\$4,811.00	\$5,024.00	\$941.00	\$5,154.00	\$5,367.00	\$1,284.00
PED5840	8CV40PT	Dummy						
PED5845	8CV45PT	Classroom						
PED5849	8CV49PT	Storeroom						
PED5850	8CV50PT	Dummy Freewheeling						
PED5855	8CV55PT	Classroom Freewheeling						
PED5859	8CV59PT	Storeroom Freewheeling						

Electrically Controlled Trims								
PED58910	8CV910PT	Fail Safe w/o Key Override	\$5,470.00	\$5,683.00	\$1,600.00	\$5,758.00	\$5,971.00	\$1,888.00
PED58930	8CV930PT	Fail Secure w/o Key Override						

Notes: *Cylinder not included. **Refer to catalog for available trims, trim finishes, device mixed finishes and how to order. **Listed finishes are for the Exit Device. Refer to catalog for available trims, trim finishes, device mixed finishes and how to order. 1. Handed: specify hand when ordering. 2. Contact factory for current lead time.

Exit Device Door Application (Required Selection)		
Description	Specify	Add or Deduct
Aluminum Door Application	AD	No Charge
Metal Door Application	MD	No Charge
Wood Door Application	WD	Add \$237.00 per device

PED5800 Series – Concealed Vertical Rod Device

Electrified Options for Exit Devices

Description	Specify	Add or Deduct
Delayed Egress (Ex: PED5855 D)	D	Add \$2873.00
Exit Alarm Device (cylinder is not included)	M61	Add \$828.00
Bolt Position Monitoring	M91	Add \$385.00
Touchbar Monitoring or Signaling/Request to Exit (REX)	M92	Add \$376.00
Double Touchbar Monitoring or Signaling/Request to Exit (REX)	M92 ERM	Add \$752.00
Outside Trim Monitoring or Signaling ¹	M93	Add \$349.00
Wire Routing (Trim)	WR	Add \$77.00
Motorized Electric Latch Retraction	MELR	Add \$1341.00
Latch Retraction Override (order with MELR)	VLR	Add \$1341.00
Electric Dogging	M97	Add \$698.00
Manual Dogging with Electric Device (Order with MELR or M97)	M114	No Charge

Miscellaneous Options

Description	Specify	Add or Deduct
Fire Rated Exit Device (Ex: PED5855 A)	A	Add \$249.00
6 Lobe Head Screws (Torx)	M04	Add \$86.00 per device
Milled Lever ³	M21	Add \$105.00 per device
Abrasive coat outside and inside (trim and device) ²	M23	Add \$199.00 per device
Abrasive coat inside only (device side)	M24	Add \$136.00 per device
Abrasive coat outside only (trim side) ²	M25	Add \$63.00 per device
Dogging Indicator	M48	Add \$104.00 per device
Photoluminescent Push	M49	Add \$510.00 per device
Less dogging	M51	No Charge
Cylinder dogging (less cylinder)	M52	Add \$72.00 per device
Through Bolts	M54	Add \$35.00 per device
Less Bottom Rod	M55	No Charge
Hurricane Code	HC	Add \$177.00 per device
Windstorm Certified	M107	No Charge
Overlapping End Cap	M111	No Charge
5lb Pressure Release	5CH	Add \$86.00 per device

1. M93 only available with PED5810, PED5845, PED5849, PED58910 & PED58930.
2. Not available with Muséo levers.
3. M21 not available with PED5801.
4. WR option standard with PED58910 & PED58930. Otherwise only available with PED5810, PED5845 & PED5849.

Cylinder Options*		
Description	Specify Quick Code	Add or Deduct
Conventional 6-pin	6P*	Add \$130.00 per cylinder
Conventional 7-pin	7P	Add \$132.00 per cylinder
LFIC		
LFIC 6-pin	C6	Add \$242.00 per cylinder
LFIC 6-pin less core	CL6	Add \$130.00 per cylinder
LFIC 6-pin with temporary construction core (Red)	CT6R	Add \$242.00 per cylinder
LFIC 6-pin with temporary construction core (Blue)	CT6B	Add \$242.00 per cylinder
LFIC 6-pin with temporary construction core (Green)	CT6G	Add \$242.00 per cylinder
LFIC 6-pin with temporary disposable core	CT6D	Add \$130.00 per cylinder
LFIC 7-pin	C7	Add \$246.00 per cylinder
LFIC 7-pin less core	CL7	Add \$132.00 per cylinder
LFIC 7-pin with temporary construction core (Red)	CT7R	Add \$246.00 per cylinder
LFIC 7-pin with temporary construction core (Blue)	CT7B	Add \$246.00 per cylinder
LFIC 7-pin with temporary construction core (Green)	CT7G	Add \$246.00 per cylinder
LFIC 7-pin with temporary disposable core	CT7D	Add \$132.00 per cylinder
SFIC		
SFIC 6-pin	C6S	Add \$231.00 per cylinder
SFIC 6-pin with temporary construction core (Blue)	CT6SB	Add \$231.00 per cylinder
SFIC 6-pin with SFIC disposable temporary core	CT6SD	Add \$130.00 per cylinder
SFIC 6-pin with Less Core	CLS6	Add \$130.00 per cylinder
SFIC 7-pin	C7S	Add \$231.00 per cylinder
SFIC 7-pin with temporary construction core (Blue)	CT7SB	Add \$231.00 per cylinder
SFIC 7-pin with SFIC disposable temporary core	CT7SD	Add \$130.00 per cylinder
SFIC 7-pin with Less Core	CLS7	Add \$130.00 per cylinder
Security		
Security ³	HS	Add \$301.00 per cylinder
Security LFIC ³	CHS	Add \$409.00 per cylinder
Access 3		
Access 3 Patented	AP	Add \$130.00 per cylinder
Access 3 Security	AS	Add \$214.00 per cylinder
Access 3 High Security, UL 437	AHS	Add \$250.00 per cylinder
Access 3 LFIC Patented	ACP	Add \$242.00 per cylinder
Access 3 LFIC Security	ACS	Add \$326.00 per cylinder
Access 3 LFIC High Security, UL 437	ACHS	Add \$362.00 per cylinder
Pyramid		
Pyramid Security fixed core	PS	Add \$220.00 per cylinder
Pyramid Security LFIC	PCS	Add \$326.00 per cylinder
Pyramid High Security fixed core	PHS	Add \$265.00 per cylinder
Pyramid High Security LFIC	PCHS	Add \$371.00 per cylinder
Pyramid LFIC with temporary construction core ³	CTP	Add \$242.00 per cylinder
Pyramid LFIC with temporary disposable core ³	CTPD	Add \$130.00 per cylinder
Pyramid LFIC less core	CLP	Add \$130.00 per cylinder

*For key bows other than 10 and 90, specify "KB" + bow number as Quick Code, e.g. KB12.

Notes: 1. CMK Construction master keying charge is in addition to master keying charge.

2. CMK Construction master keying is not available in interchangeable core, Access 3, Pyramid, or Security series.

*Optional dogging cylinder will be furnished with the same mechanism and keyed alike with the trim cylinder, unless otherwise specified. If different keying or cylinder type is required, specify outside (trim) first, then inside (dogging) cylinder.

**6P cylinder option is supplied in 6-pin, L4 keyway, 0-bitted with two nickel silver keys.

Cylinder Options & Keying Options*				
Description	Specify Quick Code		Add or Deduct	
Keying and Keys				
0-bitted with 2 Blank Keys	(standard)		No Charge	
Keyed Random	KR			
Construction Master Keyed ²	CMK			
More than 2 Keys	KY# (e.g., KY6)		See page 33 - Cut Keys Section	
Master Keying				
Master keyed (all cylinders except CR8000, CR8020, CR8027, CR8200, CR8500, CR8600, CR8700)	MK		Add \$16.00 per cylinder	
Master keyed Pyramid (except CR8020, CR8027 LFIC cores)	MK			
Master keyed Security (including LFIC cylinder and core)	MK			
Master keyed Access 3 (except CR8500, CR8600, CR8700 LFIC cores)	MK			
Master keyed (CR8000, CR8020, CR8027, CR8200, CR8500, CR8600, CR8700)	MK-IC		No Charge	
Master keyed to customer bittings or sample key	MK-CB		Add \$16.00 per cylinder	
Visual Cylinder/Key Control (VKC)				
	Cylinders		Keys	
	Stamping	List Price	Stamping	List Price
VKC0 – No stamping except keyway designation (keys will be tagged)	No Stamping	No Charge	No Stamping	\$5/key
VKC1 – Keys only	N/A	N/A	Keyset	No Charge
VKC2 – Cylinder and keys*	Keyset	\$4/cyl	Keyset	No Charge
VKC3 – Cylinder*	Keyset	\$4/cyl	Bittings	No Charge
All VKC, VDC, or VAC stamping codes that use an alternate symbol	Alternate Stamping	\$4/cyl	Alternate Stamping	\$4/cyl
Concealed Cylinder/Visual Key Control (CKC)				
	Cylinders		Keys	
	Stamping	List Price	Stamping	List Price
CKC2 – Cylinder and Keys*	Keyset	\$4/cyl	Keyset	No Charge
CKC3 – Cylinders only*	Keyset	\$4/cyl	Bittings	No Charge
All CKC, CDC, or CAC stamping codes that use an alternate symbol	Alternate Stamping	\$4/cyl	Alternate Stamping	\$4/cyl
*Cylinder face stamping not available for Access 3, Pyramid, or Security products				
Notes: 1. CMK Construction master keying charge is in addition to master keying charge. 2. CMK construction master keying is not available in interchangeable core, Access 3, Pyramid, or Security series. *For key bows other than 10 and 90, specify "KB" + bow number as Quick Code, e.g. KB12.				

Offset Pull Trim: P12, P13, P14		
Offset Pull Trim	Part Number	Finish: 605, 606, 611, 612, 613, 613E, 618, 619, 625, 626, 629, 630, 722, BSP
P12	716F50M X Finish	\$431.00
P13	716F51M X Finish	\$524.00
P14	716F52M X Finish	\$369.00

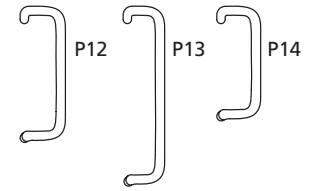

Key Only Trim: K1		
Note: Available with cylinder option only. Example K157ET x 6P. Cylinder option pricing applies.		
Aux Items	Compatible Device Functions	Finish: 605, 606, 611, 612, 613, 618, 619, 625, 626, 629, 630, BSP, WSP
K157ET	PED5247, PED5257 & PED5257T	\$88.00
K1M57ET	PED5647 & PED5657	



Anti-Vandal Pull Trim			
Trim	Compatible Device Functions	Description	630
VT950PT	PED5210, PED5410, PED5810 (MD/WD)	No Protective Lip & No Cylinder	\$913.00
VTL9M50PT	PED5610	Protective Lip & No Cylinder	
VT957PT	PED5247	No Protective Lip & Cylinder	
VTL9M57PT	PED5647	Protective Lip & Cylinder	



Auxiliary Outside Controls			
Aux Items	Description	Compatible Device Functions	Finish: 605, 606, 611, 612, 613, 618, 619, 625, 626, 629, 630, BSP, WSP
PED155	Classroom	PED58910, PED58930 & PED5850T	\$1,071.00
PED159	Storeroom		
PED355	Classroom	PED54910, PED54930 & PED5450T	
PED359	Storeroom		



Inactive/Active Dummy Bar PED5000			
Function	Description	Finish: 613E, 630, 722, BSP	Finish: 605, 606, 611, 612, 613, 618, 619, 625, 626, 629
PED5000DB	Inactive Device	\$1,217.00	\$1,352.00
PED5000ADB	Active Device	\$1,315.00	\$1,438.00

Door Height Options – PED5400 & PED5800 Exit Devices		
Door Height	Specify	Add or Deduct
6'0" - 8'11-3/4"	H0600 - H08113	No Charge
9'0" - 10'0"	H0900 - H1000	Add \$86.00 per device

*Exact door height required. Reference catalog for more information.

Above Finished Floor Options – PED5400 & PED5800 Exit Devices		
Door Height	Specify	Add or Deduct
35" - 39-1/2"	AFF035 to AFF0394	No Charge
39-5/8" (Standard)	AFF0395 (Standard)	
39-3/4" - 48"	AFF0396 to AFF048	

*Exact above finished floor required. Reference catalog for more information.

Door Width Options		
Door Width	Specify	Add or Deduct
24" to 32"	W032	No Charge
32-1/2" to 36"	W036 (Standard)	
36-1/2" to 42"	W042	
42-1/2" to 48"	W048	

*Exact Door Width required when ordering

Door Thickness Options		
Door Thickness	Specify	Add or Deduct
1-3/4"	D134 (Standard)	No Charge
2"	D200	
2-1/4"	D214	
2-3/8" to 5"	D238 up to D500*	\$468.00
2-3/8" to 5" w/ PED300		\$936.00

*Refer to catalog for available devices, trims, and auxiliary control functions.

Active Dogging Indicator Options

Description	Option	List Price
Single Indicator Inside – Unlocked/Locked – Green/Red	V01	\$368.00
Single Indicator Inside – Icons Only – Green/Red	V03	\$368.00
Single Indicator Inside – Unlocked/Locked – White/Red	V04	\$368.00
Single Indicator Inside – Icons Only – White/Red	V06	\$368.00
Inside Engraving with “Lock” and Directional Arrow (only 605,606,629,630 finishes)	EMD	\$57.00
French Indicator Option Codes		
Single Indicator Inside – Ouvert/Fermé – Green/Red	V01F	\$368.00

Ordering Examples:

Hex Dogging with Active Indicator:

Device Type	Function	Options	Hand	Finish	Door Width
PED52	47	V01	RHR	630	W036

Cylinder Dogging with Active Indicator (less cylinder):

Device Type	Function	Options	Hand	Finish	Door Width
PED52	47	V01 x M52	RHR	630	W036

Thumb Turn Dogging with Active Indicator:

Device Type/ Cylinder	Function	Options	Hand	Finish	Door Width	Cylinder
PED52	47	V01 x M52	RHR	630	W036	LC
CR1300-118-A07				630		

Notes:

- Handing must be specified.
- M52 Cylinder dogging (less cylinder) list add applies.
- Thumb Turn Mortise Cylinder CR1300 must be ordered separately. Exit Device must be ordered with M52 Cylinder Dogging and LC – Less Cylinder to be compatible with Thumb Turn Mortise Cylinder.
- Not available with A, MELR, D, M97, M61, M23, M24 and M25.
- For more information, please reference the Corbin Russwin PED4000/PED5000 Catalogs.

PED5000 Motorized Electric Latch Retraction Retrofit Kit

Kit Includes: Carrier Assembly (includes motor assembly and controller) and dogging slope plug for hex key devices.

Kit#	Rail Size	Stile	List Price	Available Options				
				M91	M92	M92 ERM	M93	5CH
PMELR	W32" (W032)	Narrow (N) Wide (W)	\$2,392.00	Add \$385.00	Add \$376.00	Add \$752.00	Add \$349.00	No Charge
	W36" (W036)							
	W42" (W042)							
	W48" (W048)							

PED5000 M92 Request to Exit Retrofit Kit

Compatible with M91 and M93 options – Kit includes the harness assembly.

Kit#	Included Option	Rail Size	Compatible Options	List Price
896F18	M92	W032/W036	M91	\$376.00
896F19		W042/W048	M91	
896F20		W032/W036	M91 M93	\$476.00
896F21		W042/W048	M91 M93	
896F22	M92 ERM	W032/W036	M91	\$564.00
896F23		W042/W048	M91	
896F24		W032/W036	M91 M93	\$664.00
896F25		W042/W048	M91 M93	

Note: The M92 retrofit harness is available with M91 and M93 option compatibility. M91 (Latchbolt Monitoring) chassis assemblies and M93 (PT Lever Monitoring) trim sold separately.

Mullions
Removable Mullions

Door Height	Description	Specify	Price
Up to 7'2"	Steel Mullion – Panic Rated	CR972	\$1,030.00
Up to 7'2"	Steel Mullion – 3 Hour Fire Rated	CR972A	\$1,432.00
Up to 10'0"	Steel Mullion – 3 Hour Fire Rated up to 8' size	CR910A ³	\$1,442.00
Up to 7'2"	Steel Mullion – 3 Hour Fire Rated, Windstorm Certified	CRFE772A ¹	\$1,785.00
Up to 8'0"	Steel Mullion – 3 Hour Fire Rated, Windstorm Certified	CRFE708A ¹	\$1,795.00
Up to 8'0"	Split Mullion – Removable – Steel – Panic Rated	CR908SM	\$1,201.00
Up to 8'0"	Aluminum Mullion – Commonly used with Narrow Stile PED4200	CRAL608	\$2,242.00
Up to 10'0"	Aluminum Mullion – Commonly used with Narrow Stile PED4200	CRAL610	\$2,384.00

Key Removable Mullions

Door Height	Description	Specify	Price
Up to 7'2"	Steel Mullion – Panic Rated	CR972KM ²	\$1,589.00
Up to 7'2"	Steel Mullion – 1-1/2 Hour Fire Rated	CR972BKM ²	\$2,204.00
Up to 10'0"	Steel Mullion – 1-1/2 Hour Fire Rated up to 8' size	CR910BKM ²	\$2,214.00
Up to 7'2"	Steel Mullion – 3 Hour Fire Rated, Windstorm Certified	CRWS772AKM ²	\$2,504.00
Up to 8'0"	Steel Mullion – 3 Hour Fire Rated, Windstorm Certified	CRWS708AKM ²	\$2,514.00
Up to 8'0"	Split Mullion – Lockable – Steel – Panic Rated	CR908KMSM	\$1,774.00

Notes:

- For use with UL approved door assemblies that comply to FEMA 361 and FEMA 320 guidelines.
For the latest listings on compliant door assemblies visit our website at www.corbinrusswin.com.
- Mullion Cylinder Kit not included with Keyed Removable (KM) Mullions. Must order separately..
- Mullions longer than 8" must be ordered as fire rated option x 10' length. Fire rating is valid only up to 96".

Mullion Cylinder Kits

Door Height	Description	Specify	Price
Up to 7'2"	CR972KM – Steel Mullion – Key Removable, Panic Rated	CRMCK1	\$130.00
Up to 7'2"	CR972BKM – Steel Mullion – Key Removable, 1-1/2 Hour Fire Rated		
Up to 10'0"	CR910BKM – Steel Mullion – Key Removable, 1-1/2 Hour Fire Rated up to 8'		
Up to 8'0"	CR908KMSM – Split Mullion – Split Mullion, Lockable, Steel, Panic Rated	CRMCK2	
Up to 7'2"	CRWS772AKM – Steel Mullion – Key Removable, 3 Hr Fire Rated, Windstorm Certified		
Up to 8'0"	CRWS708AKM – Steel Mullion – Key Removable, 3 Hr Fire Rated, Windstorm Certified		

*Specify Finish and Cylinder Key Code when ordering. Example: CRMCK1 x FINISH x CYLINDER CODE (i.e. CRMCK1 x 630 x CT6R)

Mullions Cylinder Options

Description	Specify	Add or Deduct
Conventional 6-pin	6P	Add \$130.00 per cylinder
Conventional 7-pin	7P	Add \$132.00 per cylinder
LFIC 6-pin	C6	Add \$242.00 per cylinder
LFIC 7-pin	C7	Add \$246.00 per cylinder
Pyramid High Security Fixed Core	PHS	Add \$265.00 per cylinder
Pyramid Security Fixed Core	PS	Add \$220.00 per cylinder
Pyramid High Security IC	PCHS	Add \$371.00 per cylinder
Pyramid Security IC	PCS	Add \$326.00 per cylinder
Security	HS	Add \$301.00 per cylinder
Security IC	CHS	Add \$409.00 per cylinder
LFIC 6-pin with temporary construction core (Red)	CT6R	Add \$242.00 per cylinder
LFIC 6-pin with temporary construction core (Blue)	CT6B	Add \$242.00 per cylinder
LFIC 6-pin with temporary construction core (Green)	CT6G	Add \$242.00 per cylinder
LFIC 6-pin with temporary disposable core	CT6D	Add \$130.00 per cylinder
LFIC 6-pin less core	CL6	Add \$130.00 per cylinder
LFIC 7-pin with temporary construction core (Red)	CT7R	Add \$246.00 per cylinder
LFIC 7-pin with temporary construction core (Blue)	CT7B	Add \$246.00 per cylinder
LFIC 7-pin with temporary construction core (Green)	CT7G	Add \$246.00 per cylinder
LFIC 7-pin with temporary disposable core	CT7D	Add \$132.00 per cylinder
LFIC 7-pin less core	CL7	Add \$132.00 per cylinder

Options

Description	Specify	Add or Deduct
Door frame filler block for double rabbetted frames	M95	Add \$49.00 per mullion
Door frame angle bracket for aluminum frames	M96	Add \$49.00 per mullion
Mullion stabilizer	M57	Add \$73.00 per mullion

Mullion Accessories

Description	Specify	Add or Deduct
Wallholder Kit (for use with CR972BKM & CR910BKM only)	886F970	\$396.00



The PathLite™ patent pending technology offers a number of benefits:

- Requires no wiring or maintenance
- Recharges with exposure to ambient light
- Unaffected by heat or cold
- Non-toxic, will not rub or fade
- Vandal resistant
- Fire resistant and non-radioactive
- Green contrasting word “EXIT” centered on touchbar in 1-1/4" high lettering
- Cost effective; especially suited for existing buildings

PathLite™ photoluminescent exit devices meet New York City’s newly adopted standards for requirement of photoluminescent signage and stairwell markings in all office buildings in excess of 75 feet in height.

How To Order Complete Device

Exit Device	Trim/Function	Finish	Hand	Misc. Options
ED4200	A810	630	RHR	M49

ED4200 x A810 x 630 x RHR x M49

Options	Specify	Price
24", 36" , and 48" PathLite™ Photoluminescent Touchbar Cover	M49	Add \$510.00 per device

How to Order Touchbar Cover Only

Options	Part Number	Price
24" PathLite™ Photoluminescent Touchbar cover	710F797	\$510.00
36" PathLite™ Photoluminescent Touchbar cover	710F737	
48" PathLite™ Photoluminescent Touchbar cover	710F747	

**Standard Features
Handing**

Devices are field reversible; specify hand. Lever trims are handed; specify hand

Door Thickness

1-3/4"

Product	Minimum Stile
ED4200S	2"
ED4200SM	3 1/2"
ED4200SMA	3 1/2"
ED4200	2"
ED4200M	3 1/2"
ED4200MA	3 1/2"
ED4400	2"
ED4400M	3 1/2"
ED4400MA	3 1/2"
ED4800	2"
ED4800M	3 1/2"
ED4800MA	3 1/2"

Projection

3-1/4"; 2-3/4" dogged

Trim

Cylinder is not included. See page 302 for cylinder options

Door Width

36"

SecureBolt®

ED4200S Panic
ED4200SM Panic
ED4200SMA 3 Hour Fire Rated

Rim

ED4200 Panic
ED4200M Panic
ED4200MA 3 Hour Fire Rated

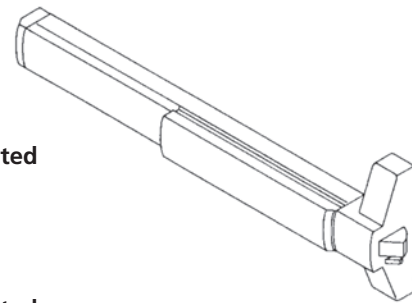

Surface Vertical Rod

ED4400 Panic
ED4400M Panic
ED4400MA 3 Hour Fire Rated

Concealed Vertical Rod

ED4800 Panic
ED4800M Panic
ED4800MA 3 Hour Fire Rated

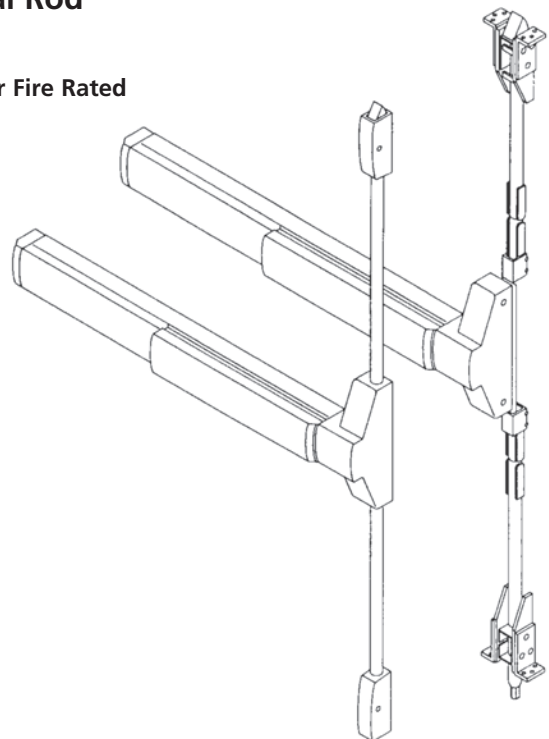

Ordering Example

Exit Device Only

Quantity	Exit Device	Finish	Hand	Misc. Options
20	ED4200	606	RHR	M51-M54

Removable Mullions

Quantity	Mullion	Finish	Misc. Options
12	CR808	695	M57

Exit Device with Trim

Quantity	Exit Device	Trim/Function	Finish	Hand	Door Thickness	Door Width	Door Height	Misc. Options
10	ED4400	N855ET	605	LHR	D200	W048	H0706	M51-M54

Trim Only

Quantity	Trim/Function	Finish	Hand	Door Thickness
24	N855ET	625	RHR	D214

Contract/Detailed Order - Rim Exit Device with Trim

Quantity	Keypad	Exit Device	Trim/Function	Finish	Hand	Door Height	Optional Strike	Door Width	Misc. Options	Optional Cylinder
36	AA1	ED4400	C855ET	626	LHR	H0800	S09	W048	M52-M54	7P

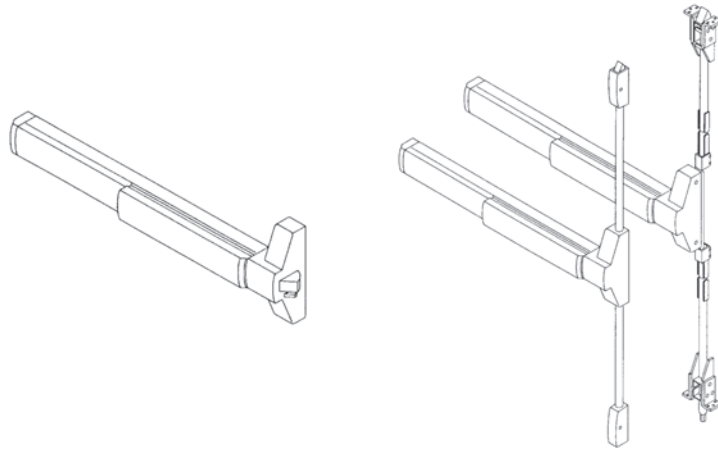

36" Device Only, See Quick Code section for 24" and 48" door width options

Includes device, strike(s) and screw pack. No cylinder or trim.

SecureBolt® ED4200S Series

Function	Description	Finish: 613E, 630, BSP, WSP	Finish: 605, 606, 611, 612, 613, 618, 619, 625, 629, 722
ED4200S	Panic	\$3,052.00	\$3,132.00
ED4200SM	Panic	\$3,052.00	\$3,132.00
ED4200SMA	3 Hour Fire Rated	\$3,301.00	\$3,381.00

Rim ED4200 Series

Function	Description	Finish: 613E, 630, BSP, WSP	Finish: 605, 606, 611, 612, 613, 618, 619, 625, 629, 722
ED4200	Panic	\$2,962.00	\$3,042.00
ED4200M	Panic	\$2,962.00	\$3,042.00
ED4200MA	3 Hour Fire Rated	\$3,211.00	\$3,291.00

Vertical Rod ED4400 Series

Function	Description	Finish: 613E, 630, BSP, WSP	Finish: 605, 606, 611, 612, 613, 618, 619, 625, 629, 722
ED4400	Panic	\$3,654.00	\$3,734.00
ED4400M	Panic	\$3,654.00	\$3,734.00
ED4400MA	3 Hour Fire Rated	\$3,903.00	\$3,983.00

Concealed V.R. ED4800 Series

Function	Description	Finish: 613E, 630, BSP, WSP	Finish: 605, 606, 611, 612, 613, 618, 619, 625, 629, 722
ED4800	Panic	\$3,655.00	\$3,735.00
ED4800M	Panic	\$3,655.00	\$3,735.00
ED4800MA	3 Hour Fire Rated	\$3,904.00	\$3,984.00

Caution: Be sure of your measurements. Exit devices are NOT returnable.

Pushpad Exit Devices

ED4000 Series: Muséo Levers with 800 Series Escutcheon

USA & Canada Prices Effective March 3, 2025

MUSÉO®

contemporary levers to complement the interior design of your next project

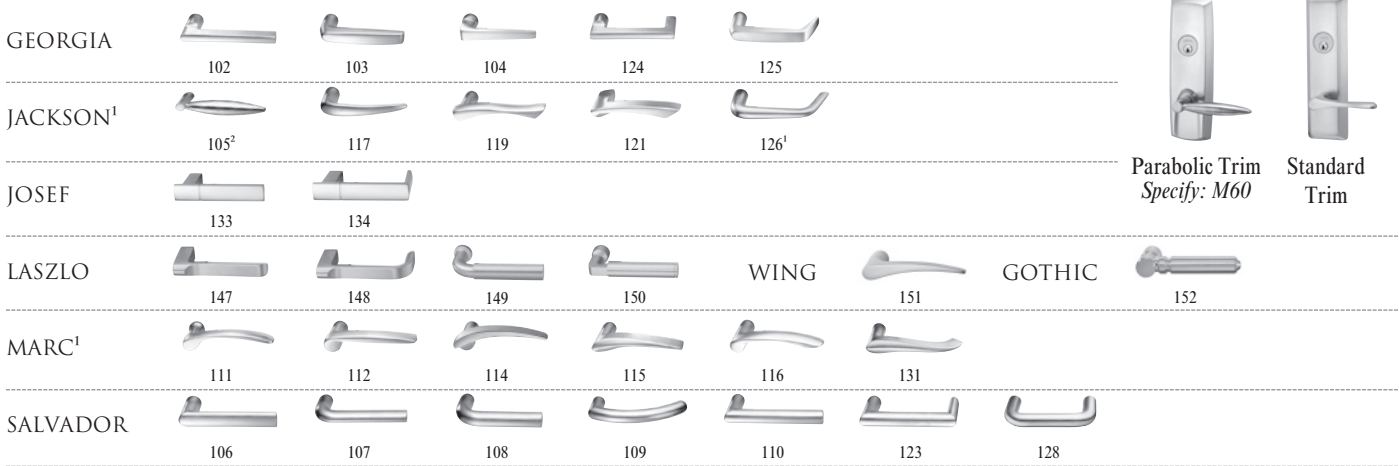

- 1. Handed: specify hand when ordering
- 2. Contact factory for current lead time

*629 and *630 finish options are Not available for all Muséo levers. Please refer to page 26 for availability.

605	Bright Brass, Clear Coated	613L	Dark Oxidized Satin Bronze, Clear Coated	BSP	Black Suede Powder Coat
606	Satin Brass, Clear Coated	618	Bright Nickel Plated	WSP	White Suede Powder Coat
611	Bright Bronze, Clear Coated	619	Satin Nickel Plated	722	Black Oxidized Bronze, Oil Rubbed
612	Satin Bronze, Clear Coated	625	Bright Chromium Plated		
613	Dark Oxidized Satin Bronze, Oil Rubbed	626	Satin Chromium Plated		
613E	Dark Oxidized Satin Bronze - Equivalent	629*	Bright Stainless Steel		
		630*	Satin Stainless Steel		

Function

Rim/SVR/CVR	810 850 855 859	Passage Dummy Classroom Storeroom	\$995.00
Options	M60	Parabolic Escutcheon	Add \$115.00 per device

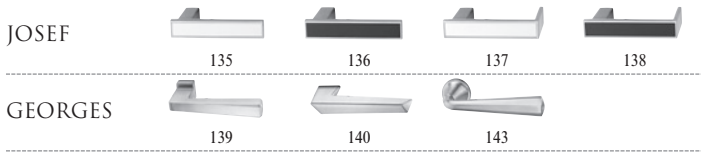

- 1. Handed: specify hand when ordering
- 2. Contact factory for current lead time

605	Bright Brass, Clear Coated	613L	Dark Oxidized Satin Bronze, Clear Coated	BSP	Black Suede Powder Coat
606	Satin Brass, Clear Coated	618	Bright Nickel Plated	WSP	White Suede Powder Coat
611	Bright Bronze, Clear Coated	619	Satin Nickel Plated	722	Black Oxidized Bronze, Oil Rubbed
612	Satin Bronze, Clear Coated	625	Bright Chromium Plated		
613	Dark Oxidized Satin Bronze, Oil Rubbed	626	Satin Chromium Plated		
613E	Dark Oxidized Satin Bronze - Equivalent	629*	Bright Stainless Steel		
		630*	Satin Stainless Steel		

Rim/SVR/CVR	810 850 855 859	Passage Dummy Classroom Storeroom	\$1,072.00
Options	M60	Parabolic Escutcheon	Add \$115.00 per device



Experience a safer and more open world

Pushpad Exit Devices

ED4000 Series: Muséo Levers with 800 Series Escutcheon

USA & Canada Prices Effective March 3, 2025



contemporary levers to complement the interior design of your next project

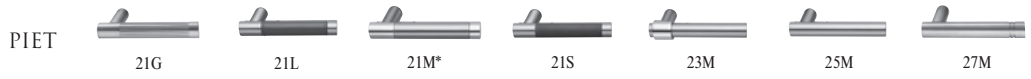

*613E, BSP, WSP finishes are not available with 21M levers.



613E	Dark Oxidized Satin Bronze – Equivalent
629	Bright Stainless Steel
630	Satin Stainless Steel
BSP	Black Suede Powder Coat
WSP	White Suede Powder Coat

Function

Rim/SVR/CVR	810 850 855 859	Passage Dummy Classroom Storeroom		\$1,072.00
Options	M60	Parabolic Escutcheon		Add \$115.00 per device



Experience a safer
and more open world

ED4200S/ED4200/ED4400/ED4800 SecureBolt®, Rim, Surface and Concealed V.R. Trim

Cylinder is not included.

Escutcheon Trim Design: A8 Armstrong



Lever: Cast

Escutcheon: Wrought

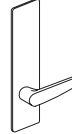

Function	Description	Finish: 605, 606, 611, 612, 613, 613E, 618, 619, 625, 626, 629, 630, 722, BSP
A810ET	Passage	\$965.00
A850ET	Dummy	
A855ET	Classroom ¹	
A859ET	Storeroom	

Escutcheon Trim Design: C8 Citation



Lever: Cast

Escutcheon: Wrought

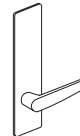

Function	Description	Finish: 605, 606, 611, 612, 613, 613E, 618, 619, 625, 626, 629, 630, 722, BSP
C810ET	Passage	\$965.00
C850ET	Dummy	
C855ET	Classroom ¹	
C859ET	Storeroom	

Escutcheon Trim Design: D8 Dirke



Lever: Cast

Escutcheon: Wrought

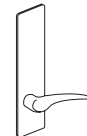

Function	Description	Finish: 605, 606, 611, 612, 613, 613E, 618, 619, 625, 626, 629, 630, 722, BSP
D810ET	Passage	\$965.00
D850ET	Dummy	
D855ET	Classroom ¹	
D859ET	Storeroom	

Note:

1. Classroom function trim may be converted to storeroom function by a simple field adjustment. No additional parts required.

ED4200S/ED4200/ED4400/ED4800 SecureBolt®, Rim, Surface and Concealed V.R. Trim

Cylinder is not included.

Escutcheon Trim Design: E8 Essex



Lever: Cast

Escutcheon: Wrought

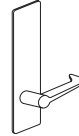

Function	Description	Finish: 605, 606, 611, 612, 613, 613E, 618, 619, 625, 626, 629, 630, 722, BSP
E810ET	Passage	\$965.00
E850ET	Dummy	
E855ET	Classroom ¹	
E859ET	Storeroom	

Escutcheon Trim Design: L8 Lustra



Lever: Cast

Escutcheon: Wrought



Function	Description	Finish: 605, 606, 611, 612, 613, 613E, 618, 619, 625, 626, 629, 630, 722, BSP
L810ET	Passage	\$965.00
L850ET	Dummy	
L855ET	Classroom ¹	
L859ET	Storeroom	

Escutcheon Trim Design: N8 Newport



Lever: Cast

Escutcheon: Wrought

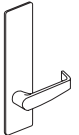

Function	Description	Finish: 605, 606, 611, 612, 613, 613E, 618, 619, 625, 626, 629, 630, 722, BSP
N810ET	Passage	\$965.00
N850ET	Dummy	
N855ET	Classroom ¹	
N859ET	Storeroom	

Escutcheon Trim Design: R8 Regis



Lever: Cast

Escutcheon: Wrought

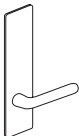

Function	Description	Finish: 605, 606, 611, 612, 613, 613E, 618, 619, 625, 626, 629, 630, 722, BSP
R810ET	Passage	\$965.00
R850ET	Dummy	
R855ET	Classroom ¹	
R859ET	Storeroom	

Note: 1. Classroom function trim may be converted to storeroom function by a simple field adjustment. No additional parts required.

ED4200S/ED4200/ED4400/ED4800 SecureBolt® , Rim, Surface and Concealed V.R. Trim

Cylinder is not included.

Escutcheon Trim Design: PR8 Princeton



Lever: Cast

Escutcheon: Wrought



Function	Description	Finish: 605, 606, 611, 612, 613, 613E, 618, 619, 625, 626, 629, 630, 722, BSP
PR810ET	Passage	\$965.00
PR850ET	Dummy	
PR855ET	Classroom ¹	
PR859ET	Storeroom	

Escutcheon Trim Design: F4 Plate

Plate: Wrought



Function	Description	Finish: 605, 606, 611, 612, 613, 613E, 618, 619, 625, 626, 629, 630, 722, BSP
F450ET	Dummy	\$383.00
F457ET	Nightlatch	

Escutcheon Trim Design: O8 Plate x Thumbturn

Plate: Wrought

Thumbturn: Cast



Function	Description	Finish: 605, 606, 612, 613, 613E, 630, 722, BSP
O810	Passage	\$781.00
O855 ¹	Classroom	
O859	Storeroom	

Note:

1. Classroom function trim may be converted to storeroom function by a simple field adjustment. No additional parts required.

ED4200S/ED4200/ED4400/ED4800 SecureBolt®, Rim, Surface and Concealed V.R. Trim

Cylinder is not included.

Escutcheon Trim Design: O14 Plate x Thumbturn

Pull: Cast **Escutcheon:** Wrought **Thumbturn:** Cast



Function	Description	Finish: 605, 606, 611, 612, 613, 613E, 618, 619, 625, 626, 629, 630, 722, BSP
O1410ET	Passage	\$954.00
O1455ET ¹	Classroom	
O1459ET	Storeroom	

Escutcheon Trim Design: T14 Pull/Thumbpiece

Grip: Cast **Escutcheon:** Wrought

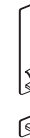

Function	Description	Finish: 605, 606, 611, 612, 613, 613E, 618, 619, 625, 626, 629, 630, 722, BSP
T1410ET	Passage	\$922.00
T1450ET	Dummy	\$835.00
T1455ET ¹	Classroom	\$922.00
T1457ET	Nightlatch (see note 2)	\$835.00

Escutcheon Trim Design: P10 Pull



Pull: Extruded **Escutcheon:** Wrought



Function	Description	Finish: 605, 606, 611, 612, 613, 613E, 618, 619, 625, 626, 629, 630, 722, BSP
P1050ET	Dummy	\$928.00
P1057ET	Nightlatch (see note 2)	

Escutcheon Trim Design: K1 Key Only

Note: Available with cylinder option only. Example: K157 x 6P
Cylinder option pricing applies.



Function	Description	Finish: 605, 606, 611, 612, 613, 618, 619, 622, 625, 626, 722
K157ET	Nightlatch ²	\$88.00

Notes:

- Classroom function trim may be converted to storeroom function by a simple field adjustment. No additional parts required.
- Not recommended for use on surface or concealed vertical rod exit devices.

Offset Pull Trim: P12, P13, P14

Offset Pull Trim	Part Number	Finish: 605, 606, 611, 612, 613, 613E, 618, 619, 625, 626, 629, 630, 722, BSP	
P12	716F50M X Finish		\$431.00
P13	716F51M X Finish		\$524.00
P14	716F52M X Finish		\$369.00

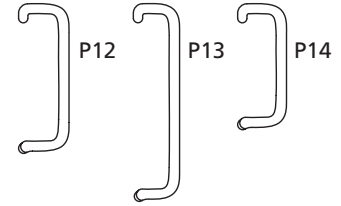

Electrified Options for Exit Devices

Description	Specify	Add or Deduct
Exit Alarm Device (cylinder is not included)	M61	\$1,151.00
Bolt Position Monitoring	M91*	Add \$340.00
Touchbar Monitoring or Signaling/Request to Exit (REX)	M92*	Add \$333.00
Outside Trim Monitoring or Signaling	M93*	
Motorized Electric Latch Retraction	MELR	Add \$1277.00
Electric Dogging	M97	Add \$649.00

Delayed Egress Device

Description	Specify	Add or Deduct
Delayed Egress (Suffix the letter D to device. Ex: ED4200)	D	Add \$2498.00
30-Second Delay	M88*	\$174.00
BOCA 15-Second Delay	M89*	
BOCA 30-Second Delay	M90*	

Electrified Accessories

Part Number	Description	Specify	Price
709F609	Power Supply 1 Amp (controls 1 'D' device)	BPS-24-1	\$543.00
709F619	Power Supply 2 Amp (controls 2 'D' devices or 1 "D" with SAF or SEC)	BPS-24-2	\$1,115.00
709F269	Power Supply 4 amp 24VDC	BPS-24-4	\$1,868.00
704F288	Concealed transfer (for over 120-degree swing door)	EPTL	\$209.00
709F689	(1) SPDT Maintained Switch (Includes LED)	MKA	\$209.00
709F709	(1) SPDT Momentary Switch (Includes LED)	MK	\$319.00
709F749	(1) SPDT Momentary Switch (Illuminated)	PB2	\$245.00
709F759	(1) SPDT Maintained (Alternating Action) Switch	PB3EA	\$188.00
709F769	(1) SPDT Momentary Switch (Illuminated)	PB3	\$237.00
709F779	(1) SPDT Momentary Switch	PB3ER	\$159.00
709F729	DPDT Momentary Key Switch	MK2	\$368.00
709F699	Narrow Stile Key Switch (Alt. action)	MKAN	\$319.00
709F719	Narrow Stile Momentary Key Switch	MKN	\$319.00
709F789	Sonalert 90db @ 2 ft. 12-24VDC. Mounted on one gang stainless steel plate.	PZ1	\$159.00
	Alarm Kit (cylinder is not included) ^{1,2}	ED40AK	\$1,308.00
709F679	Door Cord	TSB-C	\$68.00
741F739	Digital Entry System (4 users)	DK-12	\$342.00
709F809	Digital Entry System (59 users) ST finish	FADK-26SS	\$1,125.00
709F819	Digital Entry System (59 users) Black finish	DK-26BK	\$1,125.00

Notes:

- Alarm kit cannot be installed in the field to surface vertical rod exit device. Any attempt to do so voids all warranties.
- Specify Finish and Length.

***ElectroLynx®**

As part of their promise to provide innovative, fast and effective high security solutions to their customers, certain ASSA ABLOY Group brands offer *ElectroLynx®*, a universal quick-connect system that simplifies the electrification of the door opening.

Cylinder Options*		
Description	Specify Quick Code	Add or Deduct
Conventional 6-pin	6P*	Add \$130.00 per cylinder
Conventional 7-pin	7P	Add \$132.00 per cylinder
LFIC		
LFIC 6-pin	C6	Add \$242.00 per cylinder
LFIC 6-pin less core	CL6	Add \$130.00 per cylinder
LFIC 6-pin with temporary construction core (Red)	CT6R	Add \$242.00 per cylinder
LFIC 6-pin with temporary construction core (Blue)	CT6B	Add \$242.00 per cylinder
LFIC 6-pin with temporary construction core (Green)	CT6G	Add \$242.00 per cylinder
LFIC 6-pin with temporary disposable core	CT6D	Add \$130.00 per cylinder
LFIC 7-pin	C7	Add \$246.00 per cylinder
LFIC 7-pin less core	CL7	Add \$132.00 per cylinder
LFIC 7-pin with temporary construction core (Red)	CT7R	Add \$246.00 per cylinder
LFIC 7-pin with temporary construction core (Blue)	CT7B	Add \$246.00 per cylinder
LFIC 7-pin with temporary construction core (Green)	CT7G	Add \$246.00 per cylinder
LFIC 7-pin with temporary disposable core	CT7D	Add \$132.00 per cylinder
SFIC		
SFIC 6-pin	C6S	Add \$231.00 per cylinder
SFIC 6-pin with temporary construction core (Blue)	CT6SB	Add \$231.00 per cylinder
SFIC 6-pin with SFIC disposable temporary core	CT6SD	Add \$130.00 per cylinder
SFIC 6-pin with Less Core	CLS6	Add \$130.00 per cylinder
SFIC 7-pin	C7S	Add \$231.00 per cylinder
SFIC 7-pin with temporary construction core (Blue)	CT7SB	Add \$231.00 per cylinder
SFIC 7-pin with SFIC disposable temporary core	CT7SD	Add \$130.00 per cylinder
SFIC 7-pin with Less Core	CLS7	Add \$130.00 per cylinder
Security		
Security ⁴	HS	Add \$301.00 per cylinder
Security LFIC ⁴	CHS	Add \$409.00 per cylinder
Access 3		
Access 3 Patented	AP	Add \$130.00 per cylinder
Access 3 Security	AS	Add \$214.00 per cylinder
Access 3 High Security, UL 437	AHS	Add \$250.00 per cylinder
Access 3 LFIC Patented	ACP	Add \$242.00 per cylinder
Access 3 LFIC Security	ACS	Add \$326.00 per cylinder
Access 3 LFIC High Security, UL 437	ACHS	Add \$362.00 per cylinder
Pyramid		
Pyramid Security fixed core	PS	Add \$220.00 per cylinder
Pyramid Security LFIC	PCS	Add \$326.00 per cylinder
Pyramid High Security fixed core	PHS	Add \$265.00 per cylinder
Pyramid High Security LFIC	PCHS	Add \$371.00 per cylinder
Pyramid LFIC with temporary construction core ³	CTP	Add \$242.00 per cylinder
Pyramid LFIC with temporary disposable core ³	CTPD	Add \$130.00 per cylinder
Pyramid LFIC less core	CLP	Add \$130.00 per cylinder
<p>*Optional dogging cylinder will be furnished with the same mechanism and keyed alike with the trim cylinder, unless otherwise specified. If different keying or cylinder type is required, specify outside (trim) first, then inside (dogging) cylinder. **6P cylinder option is supplied in 6-pin, L4 keyway, 0-bitted with two nickel silver keys.</p> <p>*For key bows other than 10 and 90, specify "KB" + bow number as Quick Code, e.g. KB12.</p> <p>Notes: 1. CMK Construction master keying charge is in addition to master keying charge. 2. CMK Construction master keying is not available in interchangeable core, Access 3, Pyramid, or Security series.</p>		

Cylinder Options (continued) & Keying Options*				
Description	Specify Quick Code		Add or Deduct	
Keying and Keys				
0-bitted with 2 Blank Keys	(standard)		No Charge	
Keyed Random	KR			
Construction Master Keyed ²	CMK			
More than 2 Keys	KY# (e.g., KY6)		See page 33 - Cut Keys Section	
Master Keying				
Master keyed (all cylinders except CR8000, CR8020, CR8027, CR8200, CR8500, CR8600, CR8700)	MK		Add \$16.00 per cylinder	
Master keyed Pyramid (except CR8020, CR8027 LFIC cores)	MK			
Master keyed Security (including LFIC cylinder and core)	MK			
Master keyed Access 3 (except CR8500, CR8600, CR8700 LFIC cores)	MK			
Master keyed (CR8000, CR8020, CR8027, CR8200, CR8500, CR8600, CR8700)	MK-IC		No Charge	
Master keyed to customer bittings or sample key	MK-CB		Add \$16.00 per cylinder	
Visual Cylinder/Key Control (VKC)				
	Cylinders		Keys	
	Stamping	List Price	Stamping	List Price
VKC0 – No stamping except keyway designation (keys will be tagged)	No Stamping	No Charge	No Stamping	\$5/Cyl
VKC1 – Keys only	N/A	N/A	Keyset	No Charge
VKC2 – Cylinder and keys*	Keyset	\$4/Cyl	Keyset	No Charge
VKC3 – Cylinder*	Keyset	\$4/Cyl	Bittings	No Charge
All VKC, VDC, or VAC stamping codes that use an alternate symbol	Alternate Stamping	\$4/Cyl	Alternate Stamping	\$4/Cyl
Concealed Cylinder/Visual Key Control (CKC)				
	Cylinders		Keys	
	Stamping	List Price	Stamping	List Price
CKC2 – Cylinder and Keys*	Keyset	\$4/Cyl	Keyset	No Charge
CKC3 – Cylinders only*	Keyset	\$4/Cyl	Bittings	No Charge
All CKC, CDC, or CAC stamping codes that use an alternate symbol	Alternate Stamping	\$4/Cyl	Alternate Stamping	\$4/Cyl

*Cylinder face stamping not available for Access 3, Pyramid, or Security products

*For key bows other than 10 and 90, specify "KB" + bow number as Quick Code, e.g. KB12.

Notes: 1. CMK Construction master keying charge is in addition to master keying charge.

2. CMK Construction master keying is not available in interchangeable core, Access 3, Pyramid, or Security series.

Door Height Options

ED4400 Device		
Door Height	Specify	Add or Deduct
7'0"	(standard)	No Charge
7'2"	H0702	
7'6"	H0706	
8'0"	H0800	
9'0"	H0900	Add \$121.00 per device
10'0"	H1000	

ED4800 Device		
Door Height	Specify	Add or Deduct
8'0"	(standard)	No Charge
8'2"	H0802	
8'6"	H0806	
9'0"	H0900	
10'0"	H1000	Add \$121.00 per device

Door Width Options		
Door Width	Specify	Add or Deduct
24"	W024	Add \$431.00 per device
36"	(standard)	No Charge
48"	W048	Add \$53.00 per device

Door Thickness Options		
Door Thickness	Specify	Add or Deduct
1-3/4"	(standard)	No Charge
2"	D200	
2-1/4"	D214	

Strike Options		
Description	Specify	Add or Deduct
Surface or concealed vertical rod	S09	No Charge
Bottom strike for 1/2" threshold		
Flush transom top strike bracket	M67	Add \$44.00 per device

Miscellaneous Options		
Description	Specify	Add or Deduct
Torx® screws for rim, concealed vertical rod, mortise	M04	Add \$71.00 per device
Torx® screws for surface vertical rod	M04	Add \$130.00 per device
Knurling outside and inside (Embossed Touchbar - device side)	M20*	Add \$219.00 per device
Knurling outside only (trim side) ¹	M21*	Add \$105.00 per device
Knurling inside only (Embossed Touchbar - device side)	M22*	Add \$114.00 per device
Abrasive coat outside and inside (trim and device)	M23	Add \$135.00 per device
Abrasive coat inside only (device side)	M24	Add \$72.00 per device
Abrasive coat outside only (trim side)	M25	Add \$63.00 per device
Pathlite™ Photoluminescent Touchbar cover	M49	Add \$510.00 per device
Less dogging	M51	No Charge
Cylinder dogging (less cylinder)	M52	Add \$136.00 per device
Sex nuts and bolts (SNBs)	M54	No Charge
Mullion stabilizer*	M57	Add \$73.00 per mullion
Shim kit (for vision light)		
– All rim and concealed vertical rod	M58	Add \$106.00 per device
– All surface vertical rod	M58	Add \$139.00 per device
End Cap Reinforcement (used with standard end cap only)	M109	Add \$115.00 per device
Flush End Cap	M110	No Charge

1. Not available with Vineyard™ or Muséo® levers. *All levers provided in a powder coat finish will be supplied with an abrasive coating.

Removable Mullion

Ordering Example		
Quantity	Mullion Number	Finish
10	CR808	628

Door Height	Specify	Finish	Price
Up to 8'0"	CR808	628	\$2,230.00
Up to 8'0"	CR808	695	\$2,560.00

*Standard with all 808 mullions.

**Standard Features
Handing**

Devices are field reversible;
specify hand. Lever trims are
handed; specify hand.

Note:
Specify hand for all double cylin-
der exit devices

Door Thickness
1-3/4"

Door Width
36"

Projection
3-1/4"; 2-3/4" dogged

Trim
Cylinder is not included.
See page 327 for
cylinder options.

SecureBolt®
ED5200S Panic
ED5200SA 3 Hour Fire Rated
ED5202S Double Cylinder Panic,
SecureBolt®
ED5202SA Double Cylinder, Secure Bolt,
3 Hour Fire Rated

RIM
ED5200 Panic
ED5200A 3 Hour Fire Rated
ED5202 Double Cylinder Panic
ED5202A Double Cylinder; 3 Hour fire rated

Vertical Rod
ED5400 Panic
ED5470 Panic
ED5400A 3 Hour Fire Rated
ED5470B 1-1/2 Hour Fire Rated

Concealed Vertical Rod
ED5800 Panic
ED5860 Panic
ED5800A 3 Hour Fire Rated
ED5860B 1-1/2 Hour Fire Rated

Mortise
ED5600 Panic
ED5600A 3 Hour Fire Rated
ED5602L Double Cylinder Panic
(Classroom Function)
ED5602AL Double Cylinder
(Classroom Function);
3 Hour Fire Rated

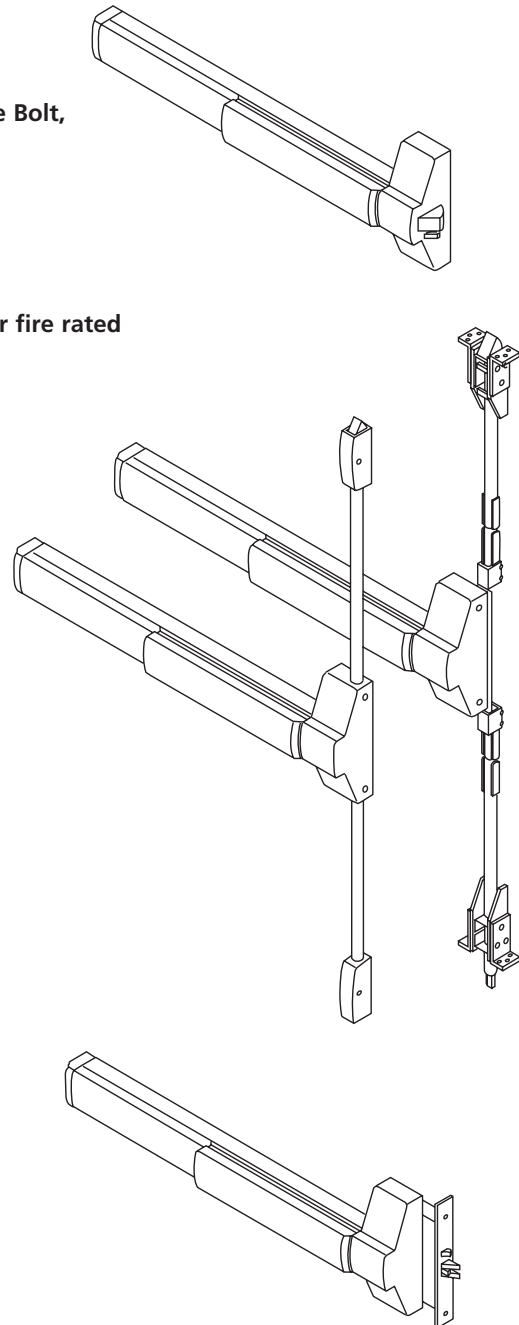

Ordering Examples
Exit Device with Trim

Quantity	Exit Device	Trim/Function	Finish	Hand	Door Thickness	Optional Strike	Door Width	Misc. Options
36	ED5600L	N9M55ET	605	LHR	D200	SB134	W048	M51-M54

Trim Only

Quantity	Trim/Function	Finish	Hand	Door Thickness
24	N955ET	625	RHR	D214

Contract/Detailed Order - Rim Exit Device with Trim

Quantity	Keypad	Exit Device	Trim/Function	Finish	Hand	Door Thickness	Door Width	Misc. Options	Optional Cylinder
36	AA1	ED5200	C955ET	613E	LHR	D200	W048	M52-M54	6P

Notes:

M55 less bottom rod option is available on ED5470(B) and ED5860(B) devices only.
H0900 and H1000 options are available on ED5470(B) and ED5860(B) devices only.
Non fire rated devices do not have a door size limitation set by UL.

36" Device Only

Includes device, strike(s) and screw pack. No cylinder or trim.

SecureBolt® ED5200S Series

Function	Description	Finish: 613E, 630, BSP, WSP	Finish: 605, 606, 611, 612, 613, 618, 619, 625, 629, 722
ED5200S	Panic	\$2,435.00	\$2,531.00
ED5202S ¹	Double Cylinder Panic <i>Classroom function Trim only</i>	\$2,730.00	\$2,826.00
ED5200SA	3 Hour Fire Rated	\$2,684.00	\$2,780.00
ED5202SA ¹	Double Cylinder 3 Hour Fire Rated <i>Classroom function Trim only</i>	\$2,979.00	\$3,075.00

Rim ED5200 Series

Function	Description	Finish: 613E, 630, BSP, WSP	Finish: 605, 606, 611, 612, 613, 618, 619, 625, 629, 722
ED5200	Panic	\$2,344.00	\$2,440.00
ED5202 ¹	Double Cylinder Panic <i>Classroom function Trim only</i>	\$2,640.00	\$2,736.00
ED5200A	3 Hour Fire Rated	\$2,593.00	\$2,689.00
ED5202A ¹	Double Cylinder 3 Hour Fire Rated <i>Classroom function Trim only</i>	\$2,889.00	\$2,985.00

Vertical Rod ED5400 Series

Function	Description	Finish: 613E, 630, BSP, WSP	Finish: 605, 606, 611, 612, 613, 618, 619, 625, 629, 722
ED5400	Panic	\$3,132.00	\$3,228.00
ED5470	Panic	\$3,220.00	\$3,316.00
ED5400A	3 Hour Fire Rated	\$3,381.00	\$3,477.00
ED5470B	1-1/2 Hour Fire Rated	\$3,469.00	\$3,565.00

Mortise ED5600 Series

Function	Description	Finish: 613E, 630, BSP, WSP	Finish: 605, 606, 611, 612, 613, 618, 619, 625, 629, 722
ED5600L	Panic	\$3,057.00	\$3,153.00
ED5657L			
ED5600T			
ED5657T			
ED5602L ¹	Double Cylinder Panic <i>Classroom function Trim only</i>	\$3,356.00	\$3,452.00
ED5600AL	3 Hour Fire Rated	\$3,306.00	\$3,402.00
ED5657AL			
ED5600AT			
ED5657AT			
ED5602AL ¹	Double Cylinder 3 Hour Fire Rated <i>Classroom function Trim only</i>	\$3,605.00	\$3,701.00

Concealed V.R. ED5800 Series

Function	Description	Finish: 613E, 630, BSP, WSP	Finish: 605, 606, 611, 612, 613, 619, 625, 629, 722
ED5800	Panic	\$3,370.00	\$3,466.00
ED5860	Panic	\$3,544.00	\$3,640.00
ED5800A	3 Hour Fire Rated	\$3,619.00	\$3,715.00
ED5860B	1-1/2 Hour Fire Rated	\$3,793.00	\$3,889.00

Inactive Bar ED5000DB Series

Function	Description	Finish: 613E, 630, BSP, WSP	Finish: 605, 606, 611, 612, 613, 619, 625, 629, 722
ED5000DB	Inactive Bar	\$1,155.00	\$1,251.00

1.Specify handing for double cylinder devices
 Only classroom function trim can be used with double cylinder devices.
 Caution: Be sure of your measurements. Exit devices are NOT returnable.

Pushpad Exit Devices

ED5000 Series: Muséo Levers with 900 Series Escutcheon

USA & Canada Prices Effective March 3, 2025



contemporary levers to complement the interior design of your next project

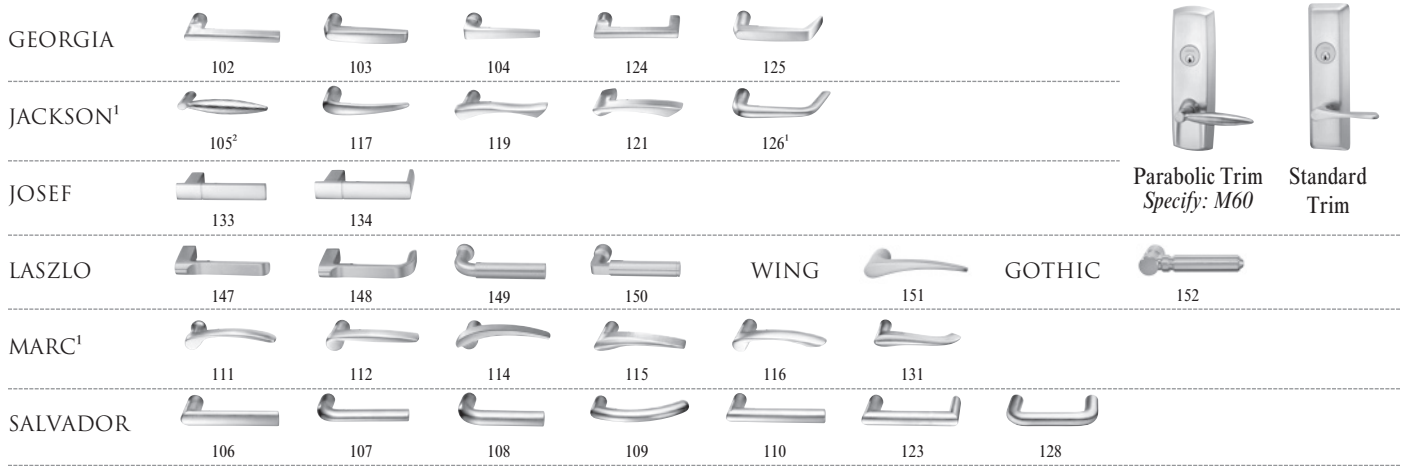

1. Handed: specify hand when ordering
2. Contact factory for current lead time

*629 and *630 finish options are Not available for all Muséo levers. Please refer to page 26 for availability.

605	Bright Brass, Clear Coated	613L	Dark Oxidized Satin Bronze, Clear Coated	BSP	Black Suede Powder Coat
606	Satin Brass, Clear Coated	618	Bright Nickel Plated	WSP	White Suede Powder Coat
611	Bright Bronze, Clear Coated	619	Satin Nickel Plated	722	Black Oxidized Bronze, Oil Rubbed
612	Satin Bronze, Clear Coated	625	Bright Chromium Plated		
613	Dark Oxidized Satin Bronze, Oil Rubbed	626	Satin Chromium Plated		
613E	Dark Oxidized Satin Bronze - Equivalent	629*	Bright Stainless Steel		
		630*	Satin Stainless Steel		

Function

Rim/SVR/CVR	910	Passage	\$995.00
	950	Dummy	
	955	Classroom	
	957	Nightlatch	
	959	Storeroom	
Mortise	9M10	Passage	\$995.00
	9M50	Dummy	
	9M55	Classroom	
	9M57	Nightlatch	
Electrified	9903	Fail Safe	\$1,616.00
	9905	Fail Secure	
Options	M60	Parabolic Escutcheon	Add \$115.00 per device

Ordering Example Details

- 111 Marc family lever
- 9M50 Dummy Trim; Mortise
- 625 Bright Chrome finish
- RHR Right Hand Reverse
- D214 2-1/4" Door Thickness
- M60 Parabolic Escutcheon Design (mechanical)



Trim Only					
Quantity	Trim/Function	Finish	Hand	Door Thickness	Option
24	1119M50	625	RHR	D214	M60



Experience a safer and more open world

Pushpad Exit Devices

ED5000 Series: Muséo Levers with 900 Series Escutcheon

USA & Canada Prices Effective March 3, 2025

contemporary levers to complement the interior design of your next project



JOSEF



GEORGES



Parabolic Trim
Specify: M60

Standard Trim

1. Handed: specify hand when ordering
2. Contact factory for current lead time

605	Bright Brass, Clear Coated	613L	Dark Oxidized Satin Bronze, Clear Coated	BSP	Black Suede Powder Coat
606	Satin Brass, Clear Coated	618	Bright Nickel Plated	WSP	White Suede Powder Coat
611	Bright Bronze, Clear Coated	619	Satin Nickel Plated	722	Black Oxidized Bronze, Oil Rubbed
612	Satin Bronze, Clear Coated	625	Bright Chromium Plated		
613	Dark Oxidized Satin Bronze, Oil Rubbed	626	Satin Chromium Plated		
613E	Dark Oxidized Satin Bronze - Equivalent	629*	Bright Stainless Steel		
		630*	Satin Stainless Steel		

Function

Rim/SVR/CVR	910	Passage	\$1,072.00
	950	Dummy	
	955	Classroom	
	957	Nightlatch	
	959	Storeroom	
Mortise	9M10	Passage	\$1,072.00
	9M50	Dummy	
	9M55	Classroom	
	9M57	Nightlatch	
Electrified	9903	Fail Safe	\$1,739.00
	9905	Fail Secure	
Options	M60	Parabolic Escutcheon	Add \$115.00 per device

Ordering Example Details

- 133 Josef family lever
- 9M50 Dummy Trim; Mortise
- 625 Bright Chrome finish
- RHR Right Hand Reverse
- D214 2-1/4" Door Thickness
- M60 Parabolic Escutcheon Design (mechanical)



Trim Only						
Quantity	Trim/Function	Finish	Hand	Door Thickness	Option	
24	1339M50	625	RHR	D214	M60	



Experience a safer and more open world

Pushpad Exit Devices

ED5000 Series: Muséo Levers with 900 Series Escutcheon

USA & Canada Prices Effective March 3, 2025

contemporary levers to complement the interior design of your next project

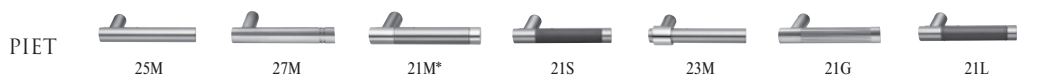

*613E, BSP, WSP finishes are not available with 21M levers.



613E	Dark Oxidized Satin Bronze – Equivalent
629	Bright Stainless Steel
630	Satin Stainless Steel
BSP	Black Suede Powder Coat
WSP	White Suede Powder Coat

Function

Rim/SVR/CVR	910	Passage	\$1,072.00
	950	Dummy	
	955	Classroom	
	957	Nightlatch	
	959	Storeroom	
Mortise	9M10	Passage	\$1,072.00
	9M50	Dummy	
	9M55	Classroom	
	9M57	Nightlatch	
Electrified	9903	Fail Safe	\$1,739.00
	9905	Fail Secure	
Options	M60	Parabolic Escutcheon	Add \$115.00 per device



Ordering Example Details

21M Piet Family Lever - Polished with Satin Insert
 9M50 Dummy Trim; Mortise
 293029 Lever Finish
 Polished with satin stainless steel insert (630), polished stainless steel (629) shank and polished stainless steel (629) grip
 629 Lock Finish
 D214 2-1/4" Door Thickness
 M60 Parabolic Escutcheon Design (mechanical)

Trim Only

Quantity	Trim/Function	Lever Finish	Lock Finish	Hand	Door Thickness	Option
2	21M9M50	293029	629	RHR	D214	M60



Experience a safer and more open world

ED5200S/ED5200/ED5400/ED5800 SecureBolt®, Rim, Surface and CVR Heavy-Duty Trim

Cylinder is not included.

Escutcheon Trim Design: A9 Armstrong



Lever: Cast

Escutcheon: Forged

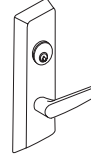

Function	Description	Finish: 605, 606, 611, 612, 613, 613E, 618, 619, 625, 626, 629 ² , 630 ¹ , 722, BSP
A910ET	Passage	\$995.00
A950ET	Dummy	
A955ET	Classroom ^{3,4}	
A957ET	Nightlatch ⁵	
A959ET	Storeroom	

Escutcheon Trim Design: C9 Citation



Lever: Cast

Escutcheon: Forged

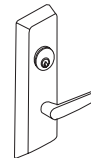

Function	Description	Finish: 605, 606, 611, 612, 613, 613E, 618, 619, 625, 626, 629 ² , 630 ¹ , 722, BSP
C910ET	Passage	\$995.00
C950ET	Dummy	
C955ET	Classroom ^{3,4}	
C957ET	Nightlatch ⁵	
C959ET	Storeroom	

Escutcheon Trim Design: D9 Dirke



Lever: Cast

Escutcheon: Forged

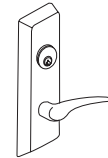

Function	Description	Finish: 605, 606, 611, 612, 613, 613E, 618, 619, 625, 626, 629 ² , 630 ¹ , 722, BSP
D910ET	Passage	\$995.00
D950ET	Dummy	
D955ET	Classroom ^{3,4}	
D957ET	Nightlatch ⁵	
D959ET	Storeroom	

Notes:

1. 619 finish provided to match 630 finish
2. 618 finish provided to match 629 finish.
3. Classroom function trim may be converted to storeroom function by a simple field adjustment. No additional parts required.
4. Only Classroom function may be used with Double Cylinder exit devices.
5. Not recommended for use with surface or concealed vertical rod exit devices (ED5400, ED5800)

ED5200S/ED5200/ED5400/ED5800 SecureBolt®, Rim, Surface and CVR Heavy-Duty Trim

Cylinder is not included.

Escutcheon Trim Design: E9 Essex



Lever: Cast

Escutcheon: Forged



Function	Description	Finish: 605, 606, 611, 612, 613, 613E, 618, 619, 625, 626, 629 ² , 630 ¹ , 722, BSP
E910ET	Passage	\$995.00
E950ET	Dummy	
E955ET	Classroom ^{3,4}	
E957ET	Nightlatch ⁵	
E959ET	Storeroom	

Escutcheon Trim Design: L9 Lustra



Lever: Cast

Escutcheon: Forged



Function	Description	Finish: 605, 606, 611, 612, 613, 613E, 618, 619, 625, 626, 629 ² , 630 ¹ , 722, BSP
L910ET	Passage	\$995.00
L950ET	Dummy	
L955ET	Classroom ^{3,4}	
L957ET	Nightlatch ⁵	
L959ET	Storeroom	

Escutcheon Trim Design: N9 Newport



Lever: Cast

Escutcheon: Forged

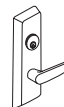

Function	Description	Finish: 605, 606, 611, 612, 613, 613E, 618, 619, 625, 626, 629 ² , 630 ¹ , 722, BSP
N910ET	Passage	\$995.00
N950ET	Dummy	
N955ET	Classroom ^{3,4}	
N957ET	Nightlatch ⁵	
N959ET	Storeroom	

Escutcheon Trim Design: R9 Regis



Lever: Cast

Escutcheon: Forged

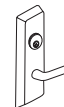

Function	Description	Finish: 605, 606, 611, 612, 613, 613E, 618, 619, 625, 626, 629 ² , 630 ¹ , 722, BSP
R910ET	Passage	\$995.00
R950ET	Dummy	
R955ET	Classroom ^{3,4}	
R957ET	Nightlatch ⁵	
R959ET	Storeroom	

Notes:

1. 619 finish provided to match 630 finish. - Escutcheons only
2. 618 finish provided to match 629 finish. - Escutcheons only
3. Classroom function trim may be converted to storeroom function by a simple field adjustment. No additional parts required.

4. Only Classroom function trim may be used with Double Cylinder exit devices.
5. Not recommended for use with surface or concealed vertical rod exit devices (ED5400, ED5800)

ED5200S/ED5200/ED5400/ED5800 SecureBolt®, Rim, Surface and CVR Heavy-Duty Trim

Cylinder is not included.

Escutcheon Trim Design: PR9 Princeton



Lever: Cast

Escutcheon: Forged



Function	Description	Finish: 605, 606, 611, 612, 613, 613E, 618, 619, 625, 626, 629 ² , 630 ¹ , 722, BSP
PR910ET	Passage	\$995.00
PR950ET	Dummy	
PR955ET	Classroom ^{3,4}	
PR957ET	Nightlatch ⁵	
PR959ET	Storeroom	

Escutcheon Trim Design: F9

Lever: Cast

Escutcheon: Forged



Function	Description	Finish: 605, 606, 611, 612, 613, 613E, 618, 619, 625, 626, 629 ² , 630 ¹ , 722, BSP
F950ET	Dummy	\$459.00
F957ET	Nightlatch ⁵	

Escutcheon Trim Design: VT9

Plate: Stamped or Formed Stainless Steel



Function	Description	Finish: 630 ¹
VT957ET	Nightlatch ⁶	\$913.00
VTL957ET	Nightlatch with Lip ⁶	
VT950ET	Pull	
VTL950ET	Pull with Lip	

Notes:

1. 619 finish provided to match 630 finish. - Escutcheons only
2. 618 finish provided to match 629 finish. - Escutcheons only
3. Classroom function trim may be converted to storeroom function by a simple field adjustment. No additional parts required.
4. Only Classroom function trim may be used with Double Cylinder exit devices.
5. Not recommended for use with surface or concealed vertical rod exit devices (ED5400, ED5800)
6. VT957 and VTL957 trims are handed and not reversible

ED5200S/ED5200/ED5400/ED5800 SecureBolt®, Rim, Surface and CVR Heavy-Duty Trim

Cylinder is not included.

Escutcheon Trim Design: FR9 Frascati*



Escutcheon: Forged

* Handed Lever. Handing cannot be changed in the field.

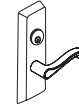

Function	Description	Finish: 605, 606, 611, 612, 613, 613E, 618, 619, 625, 626, 629 ² , 630 ¹ , 722, BSP
FR910ET	Passage	\$995.00
FR950ET	Dummy	
FR955ET	Classroom ^{3, 4}	
FR957ET	Nightlatch ⁵	
FR959ET	Storeroom	

Escutcheon Trim Design: M9 Merlot



Escutcheon: Forged

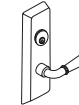

Function	Description	Finish: 605, 606, 611, 612, 613, 613E, 618, 619, 625, 626, 629 ² , 630 ¹ , 722, BSP
M910ET	Passage	\$995.00
M950ET	Dummy	
M955ET	Classroom ^{3, 4}	
M957ET	Nightlatch ⁵	
M959ET	Storeroom	

Escutcheon Trim Design: Z9 Zinfandel*



Escutcheon: Forged

* Handed Lever. Handing cannot be changed in the field.

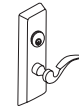

Function	Description	Finish: 605, 606, 611, 612, 613, 613E, 618, 619, 625, 626, 629 ² , 630 ¹ , 722, BSP
Z910ET	Passage	\$995.00
Z950ET	Dummy	
Z955ET	Classroom ^{3, 4}	
Z957ET	Nightlatch ⁵	
Z959ET	Storeroom	

Notes:

- 3. Classroom function trim may be converted to storeroom function by a simple field adjustment. No additional parts required.
- 4. Only Classroom function trim may be used with Double Cylinder exit devices.
- 5. Not recommended for use with surface or concealed vertical rod exit devices.

ED5200S/ED5200/ED5400/ED5800 SecureBolt®, Rim, Surface and CVR Trim

Cylinder is not included.

Escutcheon Trim Design: TH900 Pull/Thumbpiece

Grip: Extruded **Escutcheon:** Forged



Function	Description	Finish: 605, 606, 611, 612, 613, 613E, 618, 619, 625, 626, 629 ² , 630 ¹ , 722, BSP
TH910ET	Passage	\$757.00
TH950ET	Dummy (No thumbpiece)	\$719.00
TH955ET	Classroom ^{3,4}	\$757.00
TH957ET	Nightlatch ⁵ (No thumbpiece)	\$719.00
TH959ET	Storeroom	\$757.00

Escutcheon Trim Design: P9 Pull



Pull: Extruded **Escutcheon:** Forged

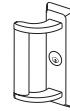

Function	Description	Finish: 605, 606, 611, 612, 613, 613E, 618, 619, 625, 626, 629 ² , 630 ¹ , 722, BSP
P950ET*	Dummy	\$652.00
P957ET*	Nightlatch ⁵	

* Specify Hand. Field Reversible.

Escutcheon Trim Design: K1 Key Only

Note: Only available with cylinder option. Example K157 x 6P
Cylinder option pricing applies.



Function	Description	Finish: 605, 606, 611, 612, 613, 618, 619, 622, 625, 626, 722
K157ET	Nightlatch ⁵	\$88.00

- Note:
1. 619 finish provided to match 630 finish. - Escutcheons only
 2. 618 finish provided to match 629 finish. - Escutcheons only
 3. Classroom function trim may be converted to storeroom function by a simple field adjustment. No additional parts required.
 4. Only Classroom function trim may be used with Double Cylinder exit devices.
 5. Not recommended for use on surface or concealed vertical rod exit devices.

ED5600 Mortise Heavy-Duty Trim

Cylinder is not included.

Escutcheon Trim Design: A4M Armstrong



Lever: Cast

Escutcheon: Forged

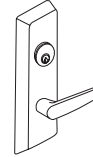

Function	Description	Finish: 605, 606, 611, 612, 613, 613E, 618, 619, 625, 626, 629 ² , 630 ¹ , 722, BSP
A9M10ET	Passage ³	\$995.00
A9M50ET	Dummy ³	
A9M55ET	Classroom ^{4, 5}	
A9M57ET	Nightlatch ⁴	

Escutcheon Trim Design: C9M Citation



Lever: Cast

Escutcheon: Forged

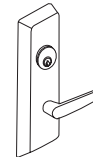

Function	Description	Finish: 605, 606, 611, 612, 613, 613E, 618, 619, 625, 626, 629 ² , 630 ¹ , 722, BSP
C9M10ET	Passage ³	\$995.00
C9M50ET	Dummy ³	
C9M55ET	Classroom ^{4, 5}	
C9M57ET	Nightlatch ⁴	

Escutcheon Trim Design: D9M Dirke*



Lever: Cast

Escutcheon: Forged

* Handed Lever. Handing cannot be changed in the field.

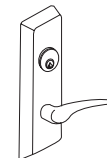

Function	Description	Finish: 605, 606, 611, 612, 613, 613E, 618, 619, 625, 626, 629 ² , 630 ¹ , 722, BSP
D9M10ET	Passage ³	\$995.00
D9M50ET	Dummy ³	
D9M55ET	Classroom ^{4, 5}	
D9M57ET	Nightlatch ⁴	

Notes:

1. 619 finish provided to match 630 finish. - Escutcheons only
2. 618 finish provided to match 629 finish. - Escutcheons only
3. Dummy and passage functions are the same. For dummy function, mortise lock body must be installed in the locked mode. No additional parts required.
4. Classroom and nightlatch function trims are the same. Trim function must be specified when ordered with an exit device to ensure that the correct lock body is supplied.
5. Only Classroom function trim may be used with Double Cylinder exit devices.

ED5600 Mortise Heavy-Duty Trim

Cylinder is not included.

Escutcheon Trim Design: E9M Essex



Lever: Cast

Escutcheon: Forged

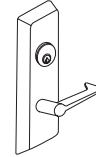

Function	Description	Finish: 605, 606, 611, 612, 613, 613E, 618, 619, 625, 626, 629 ² , 630 ¹ , 722, BSP
E9M10ET	Passage ³	\$995.00
E9M50ET	Dummy ³	
E9M55ET	Classroom ^{4, 5}	
E9M57ET	Nightlatch ⁴	

Escutcheon Trim Design: L9M Lustra



Lever: Cast

Escutcheon: Forged

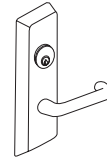

Function	Description	Finish: 605, 606, 611, 612, 613, 613E, 618, 619, 625, 626, 629 ² , 630 ¹ , 722, BSP
L9M10ET	Passage ³	\$995.00
L9M50ET	Dummy ³	
L9M55ET	Classroom ^{4, 5}	
L9M57ET	Nightlatch ⁴	

Escutcheon Trim Design: N9M Newport



Lever: Cast

Escutcheon: Forged

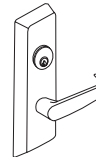

Function	Description	Finish: 605, 606, 611, 612, 613, 613E, 618, 619, 625, 626, 629 ² , 630 ¹ , 722, BSP
N9M10ET	Passage ³	\$995.00
N9M50ET	Dummy ³	
N9M55ET	Classroom ^{4, 5}	
N9M57ET	Nightlatch ⁴	

Notes:

1. 619 finish provided to match 630 finish. - Escutcheons only
2. 618 finish provided to match 629 finish. - Escutcheons only
3. Dummy and passage functions are the same. For dummy function, mortise lock body must be installed in the locked mode. No additional parts required.
4. Classroom and nightlatch function trims are the same. Trim function must be specified when ordered with an exit device to ensure that the correct lock body is supplied.
5. Only Classroom function trim may be used with Double Cylinder exit devices.

ED5600 Mortise Heavy-Duty Trim

Cylinder is not included.

Escutcheon Trim Design: R9M Regis



Lever: Cast

Escutcheon: Forged

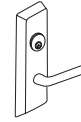

Function	Description	Finish: 605, 606, 611, 612, 613, 613E, 618, 619, 625, 626, 629 ² , 630 ¹ , 722, BSP
R9M10ET	Passage ³	\$995.00
R9M50ET	Dummy ³	
R9M55ET	Classroom ^{4, 5}	
R9M57ET	Nightlatch ⁴	

Escutcheon Trim Design: PR9M Princeton



Lever: Cast

Escutcheon: Forged



Function	Description	Finish: 605, 606, 611, 612, 613, 613E, 618, 619, 625, 626, 629 ² , 630 ¹ , 722, BSP
PR9M10ET	Passage ³	\$995.00
PR9M50ET	Dummy ³	
PR9M55ET	Classroom ^{4, 5}	
PR9M57ET	Nightlatch ⁴	

Escutcheon Trim Design: F9

Escutcheon: Forged



Function	Description	Finish: 605, 606, 611, 612, 613, 613E, 618, 619, 625, 626, 629 ² , 630 ¹ , 722, BSP
F950ET	Dummy	\$459.00
F9M57ET	Nightlatch ⁴	

Notes:

1. 619 finish provided to match 630 finish. - Escutcheons only
2. 618 finish provided to match 629 finish. - Escutcheons only
3. Dummy and passage functions are the same. For dummy function, mortise lock body must be installed in the locked mode. No additional parts required.
4. Classroom and nightlatch function trims are the same. Trim function must be specified when ordered with an exit device to ensure that the correct lock body is supplied.
5. Only Classroom function trim may be used with Double Cylinder exit devices.

ED5600 Mortise Heavy-Duty Trim

Cylinder is not included.

Escutcheon Trim Design: FR9M Frascati*



Lever: Cast

Escutcheon: Forged



* Handed Lever. Handing cannot be changed in the field.

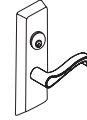

Function	Description	Finish: 605, 606, 611, 612, 613, 613E, 618, 619, 625, 626, 629 ² , 630 ¹ , 722, BSP
FR9M10ET	Passage ¹	\$995.00
FR9M50ET	Dummy ¹	
FR9M55ET	Classroom ^{2, 3}	
FR9M57ET	Nightlatch ²	

Escutcheon Trim Design: M9M Merlot



Lever: Cast

Escutcheon: Forged

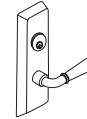

Function	Description	Finish: 605, 606, 611, 612, 613, 613E, 618, 619, 625, 626, 629 ² , 630 ¹ , 722, BSP
M9M10ET	Passage ¹	\$995.00
M9M50ET	Dummy ¹	
M9M55ET	Classroom ^{2, 3}	
M9M57ET	Nightlatch ²	

Escutcheon Trim Design: Z9M Zinfandel*



Lever: Cast

Escutcheon: Forged



* Handed Lever. Handing cannot be changed in the field.

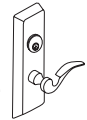

Function	Description	Finish: 605, 606, 611, 612, 613, 613E, 618, 619, 625, 626, 629 ² , 630 ¹ , 722, BSP
Z9M10ET	Passage ¹	\$995.00
Z9M50ET	Dummy ¹	
Z9M55ET	Classroom ^{2, 3}	
Z9M57ET	Nightlatch ²	

Notes:

- Dummy and passage functions are the same. For dummy function, mortise lock body must be installed in the locked mode. No additional parts required.
- Classroom and nightlatch function trims are the same. Trim function must be specified when ordered with an exit device to ensure that the correct lock body is supplied.
- Only Classroom function trim may be used with Double Cylinder exit devices.

Mortise Trim Design: ED5600

Cylinder is not included.

Escutcheon Trim Design: TH900, TH9M00 Pull/Thumbpiece

Grip: Extruded **Escutcheon:** Forged



Function	Description	Finish: 605, 606, 611, 612, 613, 613E, 618, 619, 625, 626, 629 ² , 630 ¹ , 722, BSP
TH9M10ET	Passage	\$757.00
TH950ET	Dummy (No Thumbpiece)	\$719.00
TH9M55ET	Classroom ³	\$757.00
TH9M57ET	Nightlatch (No Thumbpiece)	\$719.00

Escutcheon Trim Design: P9M Pull



Pull: Extruded **Escutcheon:** Forged

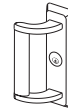

Function	Description	Finish: 605, 606, 611, 612, 613, 613E, 618, 619, 625, 626, 629 ² , 630 ¹ , 722, BSP
P950ET*	Dummy	\$652.00
P9M57ET*	Nightlatch	

*Specify Hand. Field Reversible.

Escutcheon Trim Design: VT9M

Plate: Stamped or Formed Stainless Steel



Function	Description	Finish: 630
VT9M57ET	Nightlatch	\$913.00
VTL9M57ET	Nightlatch with Lip	

Note: For mortise exit dummy functions, specify VT950 and VTL950

Escutcheon Trim Design: K1M Key Only

Note: Available with cylinder option only. Example: K1M57 x 6P
Cylinder option pricing applies.



Function	Description	Finish: 605, 606, 611, 612, 613, 618, 619, 622, 625, 626, 722
K1M57ET	Nightlatch	\$88.00

Note:
1. 619 finish provided to match 630 finish. - Escutcheons only
2. 618 finish provided to match 629 finish. - Escutcheons only
3. Only Classroom function trim may be used with Double Cylinder exit devices.

ED5200S/ED5200/ED5400/ED5800 SecureBolt® , Rim, Surface & CVR Heavy-Duty Trim

Cylinder is not included.

Escutcheon Trim Design: A9 Armstrong



Lever: Cast **Escutcheon:** Forged

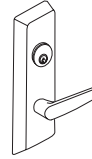

Function	Description	Finish: 605, 606, 611, 612, 613, 613E, 618, 619, 625, 626, 629 ² , 630 ¹ , 722, BSP
A9903ET*	Fail Safe	\$1,616.00
A9905ET*	Fail Secure	

Escutcheon Trim Design: C9 Citation



Lever: Cast **Escutcheon:** Forged

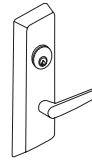

Function	Description	Finish: 605, 606, 611, 612, 613, 613E, 618, 619, 625, 626, 629 ² , 630 ¹ , 722, BSP
C9903ET*	Fail Safe	\$1,616.00
C9905ET*	Fail Secure	

Escutcheon Trim Design: D9 Dirke*



Lever: Cast **Escutcheon:** Forged
* Handed Lever. Handing cannot be changed in the field.

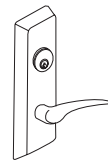

Function	Description	Finish: 605, 606, 611, 612, 613, 613E, 618, 619, 625, 626, 629 ² , 630 ¹ , 722, BSP
D9903ET*	Fail Safe	\$1,616.00
D9905ET*	Fail Secure	

Escutcheon Trim Design: E9 Essex



Lever: Cast **Escutcheon:** Forged

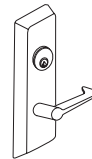

Function	Description	Finish: 605, 606, 611, 612, 613, 613E, 618, 619, 625, 626, 629 ² , 630 ¹ , 722, BSP
E9903ET*	Fail Safe	\$1,616.00
E9905ET*	Fail Secure	

Notes:
1. 619 finish provided to match 630 finish. - Escutcheons only
2. 618 finish provided to match 629 finish. - Escutcheons only

***ElectroLynx®**
As part of their promise to provide innovative, fast and effective high security solutions to their customers, certain ASSA ABLOY Group brands offer *ElectroLynx®*, a universal quick-connect system that simplifies the electrification of the door opening.

ED5200S/ED5200/ED5400/ED5800 SecureBolt®, Rim, Surface & CVR Heavy-Duty Trim

Cylinder is not included.

Escutcheon Trim Design: L9 Lustra



Lever: Cast **Escutcheon:** Forged

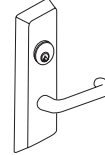

Function	Description	Finish: 605, 606, 611, 612, 613, 613E, 618, 619, 625, 626, 629 ² , 630 ¹ , 722, BSP
L9903ET*	Fail Safe	\$1,616.00
L9905ET*	Fail Secure	

Escutcheon Trim Design: N9 Newport



Lever: Cast **Escutcheon:** Forged

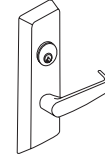

Function	Description	Finish: 605, 606, 611, 612, 613, 613E, 618, 619, 625, 626, 629 ² , 630 ¹ , 722, BSP
N9903ET*	Fail Safe	\$1,616.00
N9905ET*	Fail Secure	

Escutcheon Trim Design: R9 Regis



Lever: Cast **Escutcheon:** Forged

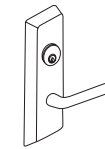

Function	Description	Finish: 605, 606, 611, 612, 613, 613E, 618, 619, 625, 626, 629 ² , 630 ¹ , 722, BSP
R9903ET*	Fail Safe	\$1,616.00
R9905ET*	Fail Secure	

Escutcheon Trim Design: PR9 Princeton



Lever: Cast **Escutcheon:** Forged

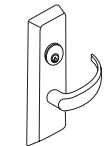

Function	Description	Finish: 605, 606, 611, 612, 613, 613E, 618, 619, 625, 626, 629 ² , 630 ¹ , 722, BSP
PR9903ET*	Fail Safe	\$1,616.00
PR9905ET*	Fail Secure	

Notes:

- 1. 619 finish provided to match 630 finish. - Escutcheons only
- 2. 618 finish provided to match 629 finish. - Escutcheons only

***ElectroLynx®**

As part of their promise to provide innovative, fast and effective high security solutions to their customers, certain ASSA ABLOY Group brands offer *ElectroLynx®*, a universal quick-connect system that simplifies the electrification of the door opening.

ED5200S/ED5200/ED5400/ED5800 SecureBolt® , Rim, Surface & CVR Heavy-Duty Trim

Cylinder is not included.

Escutcheon Trim Design: FR9 Frascati



Lever: Cast **Escutcheon:** Forged

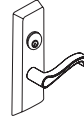

Finish: 605, 606, 611, 612, 613, 613E, 618, 619, 625, 626, 629², 630¹, 722, BSP

Function	Description	
FR9903ET*	Fail Safe	\$1,616.00
FR9905ET*	Fail Secure	

Escutcheon Trim Design: M9 Merlot



Lever: Cast **Escutcheon:** Forged

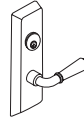

Finish: 605, 606, 611, 612, 613, 613E, 618, 619, 625, 626, 629², 630¹, 722, BSP

Function	Description	
M9903ET*	Fail Safe	\$1,616.00
M9905ET*	Fail Secure	

Escutcheon Trim Design: Z9 Zinfandel



Lever: Cast **Escutcheon:** Forged

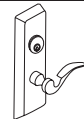

Finish: 605, 606, 611, 612, 613, 613E, 618, 619, 625, 626, 629², 630¹, 722, BSP

Function	Description	
Z9903ET*	Fail Safe	\$1,616.00
Z9905ET*	Fail Secure	

***ElectroLynx®**

As part of their promise to provide innovative, fast and effective high security solutions to their customers, certain ASSA ABLOY Group brands offer *ElectroLynx*®, a universal quick-connect system that simplifies the electrification of the door opening.

Offset Pull Trim: P12, P13, P14		
Offset Pull Trim	Part Number	Finish: 605, 606, 612, 613, 613E, 630, 626, 629, BSP, WSP
P12	716F50M X Finish	\$431.00
P13	716F51M X Finish	\$524.00
P14	716F52M X Finish	\$369.00

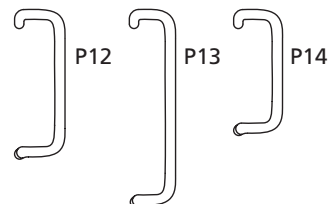
Electrified Options for Exit Devices

Description	Specify	Add or Deduct
Exit Alarm Device (cylinder is not included)	M61	\$1,151.00
Bolt Position Monitoring	M91*	Add \$340.00
Touchbar Monitoring or Signaling/Request to Exit (REX)	M92*	Add \$333.00
Outside Trim Monitoring or Signaling	M93*	
Motorized Electric Latch Retraction	MELR	
Electric Dogging	M97*	Add \$649.00
SPDT Lock and Unlock security monitor switch (Electric Trim Only)	M98*	Add \$306.00
Trim gasket for exterior applications (Electric Trim Only)	M99	Add \$34.00
Mortise device lock with Outside Trim Control (Fail Safe)	SAF2*	\$1,156.00
Mortise device lock with Outside Trim Control (Fail Secure)	SEC2*	

Delayed Egress Device

Description	Suffix	Add or Deduct
Delayed Egress (Suffix the letter D to device. Ex: ED4200)	D	Add \$2498.00
30-Second Delay	M88*	\$174.00
BOCA 15-Second Delay	M89*	
BOCA 30-Second Delay	M90*	

Notes:

- Alarm kit cannot be installed in the field to surface vertical rod exit device. Any attempt to do so voids all warranties.
- Only available with ED5600(A) (Except knob trim)
- M88, M89 and M90 are available only as options for suffix "D" Delayed Egress Exit Devices.
- The following options cannot be ordered together on the same device: a) M94 or M97 & D; b) M94 x M97; c) M52 x M97; d) M97 x M107; e) M61 or M92 & D; f) M61 x M92; g) M61x M52; h) M52 & D; i) ED5600 x M91 & M93; j) ED5600 SAF or SEC x M91 or M93; k) Surface vertical rod exit devices with M61 x M91, M92 or M93.

***ElectroLynx®**

As part of their promise to provide innovative, fast and effective high security solutions to their customers, certain ASSA ABLOY Group brands offer *ElectroLynx®*, a universal quick-connect system that simplifies the electrification of the door opening.

Retrofit Kit: MELR rail assy, no switches, no latch, with controller, touchbar end cap

Description	Specify	Price	Available Options		
			M93	M107	M93 & M107
ED5000 MELR 36" Device ASSY	CRMELR-36	\$1,277.00	\$333.00	\$127.00	\$460.00
ED5000 MELR 36" NS Device ASSY (Narrow Stile)	CRMELR-38	\$1,277.00	\$333.00	N/A	N/A
ED5000 MELR 48" Device ASSY,	CRMELR-48	\$1,277.00	\$333.00	\$127.00	\$460.00

Electrified Accessories

Part Number	Description	Specify	Price
709F609	Power Supply 1 Amp (controls 1 "D" device)	BPS-24-1	\$543.00
709F619	Power Supply 2 Amp (controls 2 "D" devices or 1 "D" with SAF or SEC)	BPS-24-2	\$1,115.00
709F629	Power Supply 4 amp 24VDC	BPS-24-4	\$1,868.00
704F288	Concealed transfer (for over 120-degree swing door)	EPTL	\$209.00
709F689	(1) SPDT Maintained Switch (Includes LED)	MKA	\$209.00
709F709	(1) SPDT Momentary Switch (Includes LED)	MK	\$319.00
709F749	(1) SPDT Momentary Switch (Illuminated)	PB2	\$245.00
709F759	(1) SPDT Maintained (Alternating Action) Switch	PB3EA	\$188.00
709F769	(1) SPDT Momentary Switch (Illuminated)	PB3	\$237.00
709F779	(1) SPDT Momentary Switch	2' PB3ER	\$159.00
709F729	DPDT Momentary Key Switch	2' MK2	\$368.00
709F699	Narrow Stile Key Switch (Alt. action)	MKAN	\$319.00
704F719	Narrow Stile Momentary Key Switch	MKN	\$319.00
709F789	Sonalert 90db @ 2 ft. 12-24VDC Mounted on one gang stainless steel plate.	PZ1	\$159.00
	Alarm Kit (cylinder is not included) ^{1,2}	ED50AK	\$1,308.00
709F679	Door Cord	TSB-C	\$68.00
741F739	Digital Entry System (4 users)	DK-12	\$342.00
709F809	Digital Entry System (59 users) SS finish	FADK-26SS	\$1,125.00
709F819	Digital Entry System (59 users) Black finish	DK-26BK	\$1,125.00
709F989	Remote Power Harness – 36"		\$209.00
709F999	Remote Power Harness – 48"		\$233.00

Notes:

1. Alarm kit cannot be installed in the field to surface vertical rod exit device. Any attempt to do so voids all warranties.
2. Specify Finish and Length.

Cylinder Options*		
Description	Specify Quick Code	Add or Deduct
Conventional 6-pin	6P*	Add \$130.00 per cylinder
Conventional 7-pin	7P	Add \$132.00 per cylinder
LFIC		
LFIC 6-pin	C6	Add \$242.00 per cylinder
LFIC 6-pin less core	CL6	Add \$130.00 per cylinder
LFIC 6-pin with temporary construction core (Red)	CT6R	Add \$242.00 per cylinder
LFIC 6-pin with temporary construction core (Blue)	CT6B	Add \$242.00 per cylinder
LFIC 6-pin with temporary construction core (Green)	CT6G	Add \$242.00 per cylinder
LFIC 6-pin with temporary disposable core	CT6D	Add \$130.00 per cylinder
LFIC 7-pin	C7	Add \$246.00 per cylinder
LFIC 7-pin less core	CL7	Add \$132.00 per cylinder
LFIC 7-pin with temporary construction core (Red)	CT7R	Add \$246.00 per cylinder
LFIC 7-pin with temporary construction core (Blue)	CT7B	Add \$246.00 per cylinder
LFIC 7-pin with temporary construction core (Green)	CT7G	Add \$246.00 per cylinder
LFIC 7-pin with temporary disposable core	CT7D	Add \$132.00 per cylinder
SFIC		
SFIC 6-pin	C6S	Add \$231.00 per cylinder
SFIC 6-pin with temporary construction core (Blue)	CT6SB	Add \$231.00 per cylinder
SFIC 6-pin with SFIC disposable temporary core	CT6SD	Add \$130.00 per cylinder
SFIC 6-pin with Less Core	CLS6	Add \$130.00 per cylinder
SFIC 7-pin	C7S	Add \$231.00 per cylinder
SFIC 7-pin with temporary construction core (Blue)	CT7SB	Add \$231.00 per cylinder
SFIC 7-pin with SFIC disposable temporary core	CT7SD	Add \$130.00 per cylinder
SFIC 7-pin with Less Core	CLS7	Add \$130.00 per cylinder
Security		
Security ⁴	HS	Add \$301.00 per cylinder
Security LFIC ⁴	CHS	Add \$409.00 per cylinder
Access 3		
Access 3 Patented	AP	Add \$130.00 per cylinder
Access 3 Security	AS	Add \$214.00 per cylinder
Access 3 High Security, UL 437	AHS	Add \$250.00 per cylinder
Access 3 LFIC Patented	ACP	Add \$242.00 per cylinder
Access 3 LFIC Security	ACS	Add \$326.00 per cylinder
Access 3 LFIC High Security, UL 437	ACHS	Add \$362.00 per cylinder
Pyramid		
Pyramid Security fixed core	PS	Add \$220.00 per cylinder
Pyramid Security LFIC	PCS	Add \$326.00 per cylinder
Pyramid High Security fixed core	PHS	Add \$265.00 per cylinder
Pyramid High Security LFIC	PCHS	Add \$371.00 per cylinder
Pyramid LFIC with temporary construction core ³	CTP	Add \$242.00 per cylinder
Pyramid LFIC with temporary disposable core ³	CTPD	Add \$130.00 per cylinder
Pyramid LFIC less core	CLP	Add \$130.00 per cylinder

*For key bows other than 10 and 90, specify "KB" + bow number as Quick Code, e.g. KB12.

Notes: 1. CMK Construction master keying charge is in addition to master keying charge.

2. CMK Construction master keying is not available in interchangeable core, Access 3, Pyramid, or Security series.

*Optional dogging cylinder will be furnished with the same mechanism and keyed alike with the trim cylinder, unless otherwise specified. If different keying or cylinder type is required, specify outside (trim) first, then inside (dogging) cylinder.

**6P cylinder option is supplied in 6-pin, L4 keyway, 0-bitted with two nickel silver keys.

Cylinder Options & Keying Options*		
Description	Specify Quick Code	Add or Deduct
Keying and Keys		
0-bitted with 2 Blank Keys	(standard)	No Charge
Keyed Random	KR	
Construction Master Keyed ²	CMK	
More than 2 Keys	KY# (e.g., KY6)	See page 33 - Cut Keys Section
Master Keying		
Master keyed (all cylinders except CR8000, CR8020, CR8027, CR8200, CR8500, CR8600, CR8700)	MK	Add \$16.00 per cylinder
Master keyed Pyramid (except CR8020, CR8027 LFIC cores)	MK	
Master keyed Security (including LFIC cylinder and core)	MK	
Master keyed Access 3 (except CR8500, CR8600, CR8700 LFIC cores)	MK	
Master keyed (CR8000, CR8020, CR8027, CR8200, CR8500, CR8600, CR8700)	MK-IC	No Charge
Master keyed to customer bittings or sample key	MK-CB	Add \$16.00 per cylinder
Visual Cylinder/Key Control (VKC)		
No stamping except keyway designation (keys will be tagged)	VKCO	No Charge
Keys only	VKC1	N/A
Cylinder and keys*	VKC2	\$4/Cyl
Cylinder*	VKC3	
All VKC, VDC, or VAC stamping codes that use an alternate symbol	AltV	
No stamping except keyway designation (keys will be tagged)	VKCO	\$5/Cyl
Keys only	VKC1	No Charge
Cylinder and keys*	VKC2	
Cylinder*	VKC3	
All VKC, VDC, or VAC stamping codes that use an alternate symbol	AltV	\$4/Cyl
Concealed Cylinder/Visual Key Control (CKC)		
Cylinder and keys*	CKC2	\$4/Cyl
Cylinder*	CKC3	
All CKC, CDC, or CAC stamping codes that use an alternate symbol	AltC	
Cylinder and keys*	CKC2	No Charge
Cylinder*	CKC3	
All CKC, CDC, or CAC stamping codes that use an alternate symbol	AltC	
Notes: 1. CMK Construction master keying charge is in addition to master keying charge. 2. CMK construction master keying is not available in interchangeable core, Access 3, Pyramid, or Security series. *For key bows other than 10 and 90, specify "KB" + bow number as Quick Code, e.g. KB12.		
Door Height Options		
ED5400, ED5400A, ED5470(B) Devices		
Door Height	Specify	Add or Deduct
7'0"	(standard)	No Charge
7'2"	H0702	
7'6"	H0706	
8'0"	H0800	
ED5800, ED5800A, ED5860(B) Devices		
Door Height	Specify	Add or Deduct
8'0"	(standard)	No Charge
ED5470(B), ED5860(B) Devices		
Door Height	Specify	Add or Deduct
9'0" ¹	H0900	Add \$121.00 per device
10'0" ¹	H1000	
Note: 1. H0900 and H1000 options for ED5470(B), ED5860(B) devices only		

Door Height Options (continued)
Door Width Options

Door Width	Specify	Add or Deduct
24"	W024	Add \$431.00 per device
36"	(standard)	No Charge
48"	W048	Add \$53.00 per device

Door Thickness Options

Door Thickness	Specify	Add or Deduct
1-3/4"	(standard)	No Charge
2"	D200	
2-1/4"	D214	

Strike Options

Description	Specify	Add or Deduct
Rim x Vertical Rod on pairs of doors	S02	Add \$54.00 per device
Surface or Concealed Vertical Rod device bottom strike for 1/2" threshold	S09	No Charge
Flush transom top strike bracket	M67	Add \$44.00 per device
Mortise Device		
-ANSI wrought strike box	M17	No Charge
-ANSI strike for pair of doors w/ astragal (7/8" L to C)	SS078	
-Open back strike for 1-3/4" door	SB134	Add \$124.00 per device
-Open back strike for 2-1/4" door	SB214	\$197.00

Miscellaneous Options

Description	Specify	Add or Deduct
Torx® screws for rim, concealed vertical rod, mortise	M04	Add \$71.00 per device
Torx® screws for surface vertical rod	M04	Add \$130.00 per device
Knurling outside and inside (Embossed Touchbar - device side) ¹	M20*	Add \$219.00 per device
Knurling outside only (trim side) ¹	M21*	Add \$105.00 per device
Knurling inside only (Embossed Touchbar - device side)	M22*	Add \$114.00 per device
Abrasive coat outside and inside (trim and device)	M23	Add \$135.00 per device
Abrasive coat inside only (device side)	M24	Add \$72.00 per device
Abrasive coat outside only (trim side)	M25	Add \$63.00 per device
Pathlite™ Photoluminescent Touchbar cover	M49	Add \$510.00 per device
Less dogging	M51	No Charge
Cylinder dogging (less cylinder)	M52	Add \$136.00 per device
Sex nuts and bolts (SNBs)	M54	No Charge
Less bottom vertical rod ²	M55	
Narrow stile cover	M56	No Charge
Shim kit (for vision light)		
- All rim and concealed vertical rod	M58	Add \$106.00 per device
- All surface vertical rod	M58	Add \$139.00 per device
- All mortise exit devices	M58	Add \$139.00 per device
Parabolic Design Exit Trim	M60	Add \$115.00 per device
Wood screws For use on fire rated solid wood or wood core doors	M64	No Charge
Trim to accept Schlage® interchangeable core (950 series trim only)	M69	No Charge
Windstorm Certified products for ED5200S(A) and ED5470(B) Only ^{3, 4, 5}	M107	Add \$127.00 per device
End Cap Reinforcement (used with standard end cap only)	M109	Add \$115.00 per device
Flush End Cap	M110	No Charge
5 lbs Pressure Release (Only available with RIM devices)	5CH	Add \$40.00

- Notes: 1. Not available with VT9, VTL9, VT9M and VTL9M trim, Vineyard™ or Muséo® levers.
2. Available with ED5470 and ED5860 series only.
3. ED5200S(A) x M107 requires through bolts.
4. ED5470(B) maximum opening height is 8'0".
5. Contact Ceco, Curries® or Fleming for detailed frame/door requirements and limitations.

*All levers provided in a powder coat finish will be supplied with an abrasive coating.

Surface Bolt™

Description	Size	Specify	Price
Surface Bolt Kit – For Approved Windstorm Code Applications - bright zinc plated finish	12" Surface Bolt Kit	988CR	\$224.00
	18" Surface Bolt Kit		
	24" Surface Bolt Kit		

Mullions

Ordering Example	
Quantity	Mullion Number
10	CR972

Removable Mullions

Door Height	Description	Specify	Price
Up to 7'2"	Steel Mullion – Panic Rated	CR972	\$1,030.00
Up to 7'2"	Steel Mullion – 3 Hour Fire Rated	CR972A	\$1,432.00
Up to 10'	Steel Mullion – 3 Hour Fire Rated up to 8' size	CR910A ³	\$1,442.00
Up to 7'2"	Steel Mullion – 3 Hour Fire Rated, Windstorm Certified	CRFE772A ¹	\$1,785.00
Up to 8'0"	Steel Mullion – 3 Hour Fire Rated, Windstorm Certified	CRFE708A ¹	\$1,795.00
Up to 8'0"	Split Mullion – Removable – Steel – Panic Rated	CR908SM	\$1,155.00

Key Removable Mullions

Door Height	Description	Specify	Price
Up to 7'2"	Steel Mullion – Panic Rated	CR972KM ²	\$1,589.00
Up to 7'2"	Steel Mullion – 1-1/2 Hour Fire Rated	CR972BKM ²	\$2,204.00
Up to 10'	Steel Mullion – 1-1/2 Hour Fire Rated up to 8' size	CR910BKM ²	\$2,214.00
Up to 7'2"	Steel Mullion – 3 Hour Fire Rated, Windstorm Certified	CRWS772AKM ²	\$2,504.00
Up to 8'0"	Steel Mullion – 3 Hour Fire Rated, Windstorm Certified	CRWS708AKM ²	\$2,514.00
Up to 8'0"	Split Mullion – Lockable – Steel – Panic Rated	CR908KMSM	\$1,774.00

- Notes:
- For use with UL approved door assemblies that comply to FEMA 361 and FEMA 320 guidelines. For the latest listings on compliant door assemblies visit our website at corbinrusswin.com.
 - Mullion Cylinder Kit not included with Keyed Removable (KM) Mullions. Must order separately.
 - Mullions longer than 8" must be ordered as fire rated option x 10' length. Fire rating is valid only up to 96".

Mullion Cylinder Kits

Door Height	Description	Specify	Price
Up to 7'2"	CR972KM – Steel Mullion – Key Removable, Panic Rated	CRMCK1	\$130.00
Up to 7'2"	CR972BKM – Steel Mullion – Key Removable, 1-1/2 Hour Fire Rated		
Up to 10'0"	CR910BKM – Steel Mullion – Key Removable, 1-1/2 Hour Fire Rated up to 8'		
Up to 8'0"	CR908KMSM – Split Mullion – Split Mullion, Lockable, Steel, Panic Rated		
Up to 7'2"	CRWS772AKM – Steel Mullion – Key Removable, 3 Hr Fire Rated, Windstorm Certified	CRMCK2	
Up to 8'0"	CRWS708AKM – Steel Mullion – Key Removable, 3 Hr Fire Rated, Windstorm Certified		

*Specify Finish and Cylinder Key Code when ordering. Example: CRMCK1 x FINISH x CYLINDER CODE (i.e. CRMCK1 x 630 x CT6R)

Mullions Cylinder Options

Description	Specify	Add or Deduct
Conventional 6-pin	6P	Add \$130.00 per cylinder
Conventional 7-pin	7P	Add \$132.00 per cylinder
LFIC 6-pin	C6	Add \$242.00 per cylinder
LFIC 7-pin	C7	Add \$246.00 per cylinder
Pyramid High Security Fixed Core	PHS	Add \$265.00 per cylinder
Pyramid Security Fixed Core	PS	Add \$220.00 per cylinder
Pyramid High Security IC	PCHS	Add \$371.00 per cylinder
Pyramid Security IC	PCS	Add \$326.00 per cylinder
Security	HS	Add \$301.00 per cylinder
Security IC	CHS	Add \$409.00 per cylinder
LFIC 6-pin with temporary construction core (Red)	CT6R	Add \$242.00 per cylinder
LFIC 6-pin with temporary construction core (Blue)	CT6B	Add \$242.00 per cylinder
LFIC 6-pin with temporary construction core (Green)	CT6G	Add \$242.00 per cylinder
LFIC 6-pin with temporary disposable core	CT6D	Add \$130.00 per cylinder
LFIC 6-pin less core	CL6	Add \$130.00 per cylinder
LFIC 7-pin with temporary construction core (Red)	CT7R	Add \$246.00 per cylinder
LFIC 7-pin with temporary construction core (Blue)	CT7B	Add \$246.00 per cylinder
LFIC 7-pin with temporary construction core (Green)	CT7G	Add \$246.00 per cylinder
LFIC 7-pin with temporary disposable core	CT7D	Add \$132.00 per cylinder
LFIC 7-pin less core	CL7	Add \$132.00 per cylinder

Options

Description	Specify	Add or Deduct
Door frame filler block for double rabbeted frames	M95	Add \$49.00 per mullion
Door frame angle bracket for aluminum frames	M96	Add \$49.00 per mullion
Mullion stabilizer	M57	Add \$73.00 per mullion

Standard Features

Handing

Handed, specify hand

Door Thickness

1-3/4"

Backset

2-3/4"

Projection

4" (102mm); 2 3/4" (70mm) depressed

Trim

Cylinder is not included.
See page 337 for
cylinder options.

Rim

ED7200

Panic

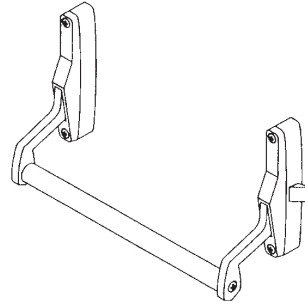

Vertical Rod

ED7400

Panic

Concealed Vertical Rod

ED7800

Panic

ED7800A

3 Hour Fire Rated

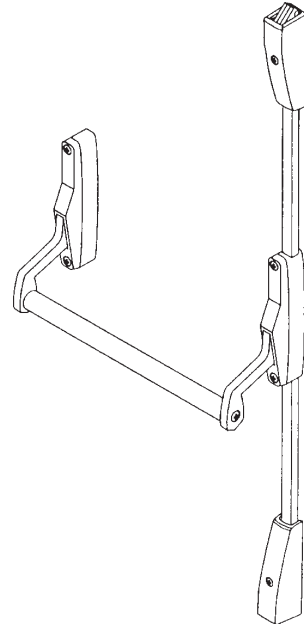

Ordering Example

Rim Exit Device

Quantity	Exit Device	Finish	Hand	Misc. Options
20	ED7200	606	RHR	M51-M54

Rim Exit Device with Trim

Quantity	Exit Device	Trim/Function	Finish	Hand	Door Thickness	Door Width	Misc. Options
50	ED7200	P557ET	630	LHR	D214	W048	M53

Trim Only (Rim Device)

Quantity	Exit Device	Finish
10	P457ET	630

Vertical Rod Exit Device with Trim

Quantity	Exit Device	Trim/Function	Finish	Hand	Door Thickness	Door Width	Misc. Options
50	ED7401	C455ET	613	RHR	D214	W048	H1000

Contract/Detailed Order - Rim Exit Device with Trim

Quantity	Keypad	Exit Device	Trim/Function	Finish	Hand	Door Thickness	Door Width	Optional Cylinders	Keying
50	AA1	ED7200	P457ET	626	LHR	D200	W048	C6	VKC3

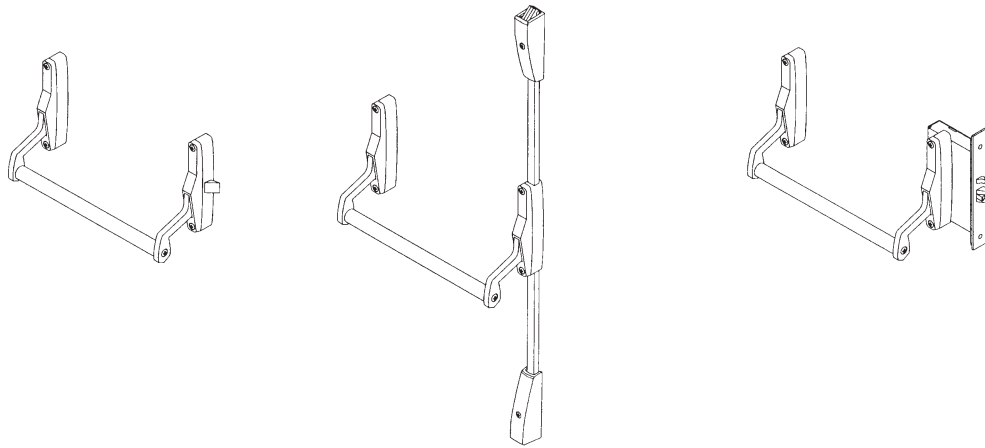

36" Device Only

Includes device, strike(s) and screw pack. No cylinder or trim.

Rim ED7200 Series

Function	Description	Finish: 613E, 626	Finish: 605, 606, 611, 612, 613, 618, 619, 625, 629, 630, 722
ED7200	Panic	\$4,304.00	\$4,381.00

Vertical Rod ED7400 Series

Function	Description	Finish: 613E, 626	Finish: 605, 606, 611, 612, 613, 618, 619, 625, 629, 630, 722
ED7400	Panic Exit Trim Only (accepts operator trim)	\$4,917.00	\$4,994.00
ED7401	Panic Exit Trim Only (accepts lever trim)		

Concealed V.R. ED7800 Series

Function	Description	Finish: 613E, 626	Finish: 605, 606, 611, 612, 613, 618, 619, 625, 629, 630, 722
ED7800	Panic	\$4,765.00	\$4,842.00
ED7800A	3 Hour Fire Rated	\$5,014.00	\$5,091.00

Caution: Be sure of your measurements. Exit devices are NOT returnable.

ED7200 Rim Trim

Cylinder is not included.

Pull Trim Design: P4 D Grip Pull



Grip: Extruded **Escutcheon:** Wrought



Function	Description	Finish: 605, 606, 611, 612, 613, 613E, 618, 619, 625, 626, 629, 630, 722
P450ET	Dummy	\$606.00
P457ET	Nightlatch	

Pull Trim Design: P5 Round Grip Pull



Grip: Extruded **Escutcheon:** Wrought



Function	Description	Finish: 605, 606, 611, 612, 613, 613E, 618, 619, 625, 626, 629, 630, 722
P550ET	Dummy	\$606.00
P557ET	Nightlatch	

Pull Trim Design: P6 Pull



Grip: Wrought
MR option available **Escutcheon:** Wrought



Function	Description	Finish: 605, 606, 611, 612, 613, 613E, 618, 619, 625, 626, 629, 630, 722
P650ET	Dummy	\$606.00
P657ET	Nightlatch	

Pull Trim Design: P7 Plate

Escutcheon: Wrought
MR option available



Function	Description	Finish: 605, 606, 611, 612, 613, 613E, 618, 619, 625, 626, 629, 630, 722
P757ET	Nightlatch	\$596.00

ED7400 Surface Vertical Rod Trim

Cylinder is not included.

Escutcheon Trim Design: C4 Citation



Lever: Cast
MR option available

Escutcheon: Wrought
Available with ED7401 device only.



Function	Description	Finish: 605, 606, 611, 612, 613, 613E, 618, 619, 625, 626, 629, 630, 722
C455ET*	Classroom	\$1,241.00
C457ET*	Nightlatch	

*1-3/4 doors only

Escutcheon Trim Design: D4 Dirke



Lever: Cast
MR option available

Escutcheon: Wrought
Available with ED7401 device only.



Function	Description	Finish: 605, 606, 611, 612, 613, 613E, 618, 619, 625, 626, 629, 630, 722
D455ET*	Classroom	\$1,241.00
D457ET*	Nightlatch	

*1-3/4 doors only

Escutcheon Trim Design: O3 D Grip Operator



Pull: Extruded
MR option available

Escutcheon: Cast
Available with ED7400 only.



Function	Description	Finish: 605, 606, 611, 612, 613, 613E, 618, 619, 625, 626, 629, 630, 722
O355ET	Classroom	\$1,241.00
O356ET**	Nightlatch	
O357ET	Nightlatch	

Escutcheon Trim Design: O4 Round Grip Operator



Pull: Extruded
MR option available

Escutcheon: Cast
Available with ED7400 only.



Function	Description	Finish: 605, 606, 611, 612, 613, 613E, 618, 619, 625, 626, 629, 630, 722
O455ET	Classroom	\$1,241.00
O456ET**	Nightlatch	
O457ET	Nightlatch	

**Key also used to hold top and bottom latchbolts in retracted position.

ED7800 Concealed Vertical Rod Trim

Cylinder is not included.

Trim Design: O5 Operator

Escutcheon: Cast



Function	Description	Finish: 605, 606, 611, 612, 613, 613E, 618, 619, 625, 626, 629, 630, 722
O557ET	Nightlatch	\$472.00

Offset Pull Trim: P12, P13, P14

Offset Pull Trim	Part Number	Finish: 605, 606, 612, 613, 613E, 626, 629, 630
P12	716F50M X Finish	\$431.00
P13	716F51M X Finish	\$524.00
P14	716F52M X Finish	\$369.00

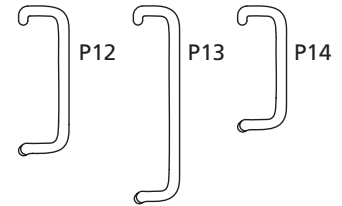

Cylinder Options*		
Description	Specify Quick Code	Add or Deduct
Conventional 6-pin	6P*	Add \$130.00 per cylinder
Conventional 7-pin	7P	Add \$132.00 per cylinder
LFIC		
LFIC 6-pin	C6	Add \$242.00 per cylinder
LFIC 6-pin less core	CL6	Add \$130.00 per cylinder
LFIC 6-pin with temporary construction core (Red)	CT6R	Add \$242.00 per cylinder
LFIC 6-pin with temporary construction core (Blue)	CT6B	Add \$242.00 per cylinder
LFIC 6-pin with temporary construction core (Green)	CT6G	Add \$242.00 per cylinder
LFIC 6-pin with temporary disposable core	CT6D	Add \$130.00 per cylinder
LFIC 7-pin	C7	Add \$246.00 per cylinder
LFIC 7-pin less core	CL7	Add \$132.00 per cylinder
LFIC 7-pin with temporary construction core (Red)	CT7R	Add \$246.00 per cylinder
LFIC 7-pin with temporary construction core (Blue)	CT7B	Add \$246.00 per cylinder
LFIC 7-pin with temporary construction core (Green)	CT7G	Add \$246.00 per cylinder
LFIC 7-pin with temporary disposable core	CT7D	Add \$132.00 per cylinder
SFIC		
SFIC 6-pin	C6S	Add \$231.00 per cylinder
SFIC 6-pin with temporary construction core (Blue)	CT6SB	Add \$231.00 per cylinder
SFIC 6-pin with SFIC disposable temporary core	CT6SD	Add \$130.00 per cylinder
SFIC 6-pin with Less Core	CLS6	Add \$130.00 per cylinder
SFIC 7-pin	C7S	Add \$231.00 per cylinder
SFIC 7-pin with temporary construction core (Blue)	CT7SB	Add \$231.00 per cylinder
SFIC 7-pin with SFIC disposable temporary core	CT7SD	Add \$130.00 per cylinder
SFIC 7-pin with Less Core	CLS7	Add \$130.00 per cylinder
Security		
Security ⁴	HS	Add \$301.00 per cylinder
Security LFIC ⁴	CHS	Add \$409.00 per cylinder
Access 3		
Access 3 Patented	AP	Add \$130.00 per cylinder
Access 3 Security	AS	Add \$214.00 per cylinder
Access 3 High Security, UL 437	AHS	Add \$250.00 per cylinder
Access 3 LFIC Patented	ACP	Add \$242.00 per cylinder
Access 3 LFIC Security	ACS	Add \$326.00 per cylinder
Access 3 LFIC High Security, UL 437	ACHS	Add \$362.00 per cylinder
Pyramid		
Pyramid Security fixed core	PS	Add \$220.00 per cylinder
Pyramid Security LFIC	PCS	Add \$326.00 per cylinder
Pyramid High Security fixed core	PHS	Add \$265.00 per cylinder
Pyramid High Security LFIC	PCHS	Add \$371.00 per cylinder
Pyramid LFIC with temporary construction core ³	CTP	Add \$242.00 per cylinder
Pyramid LFIC with temporary disposable core ³	CTPD	Add \$130.00 per cylinder
Pyramid LFIC less core	CLP	Add \$130.00 per cylinder
Other		
Less master ring cylinder ⁴	MR-LC	No Charge
Master Ring ⁴	MR	Add \$202.00 per cylinder

*6P cylinder option is supplied in 6-pin, L4 keyway, 0-bitted with two nickel silver keys.

Notes:

1. Available on outside trim only.
2. Not available on O5 trim.
3. Rim only. 4. Available on C4, D4, OBS, O3, O4 trims only.
5. Not available on ED7600 C4M, D4M, E4M B5M, G6M trims.
6. Pyramid is not available on ED7600 with door thicknesses over 2-1/4".
7. Not available on P4, P5, P5, P7 trims.

Cylinder Options & Keying Options*		
Description	Specify Quick Code	Add or Deduct
Keying and Keys		
0-bitted with 2 Blank Keys	(standard)	No Charge
Keyed Random	KR	
Construction Master Keyed ²	CMK	Add \$16.00 per cylinder
More than 2 Keys	KY# (e.g., KY6)	See page 33 - Cut Keys Section
Master Keying		
Master keyed (all cylinders except CR8000, CR8020, CR8027, CR8200, CR8500, CR8600, CR8700)	MK	Add \$16.00 per cylinder
Master keyed Pyramid (except CR8020, CR8027 LFIC cores)	MK	
Master keyed Security (including LFIC cylinder and core)	MK	
Master keyed Access 3 (except CR8500, CR8600, CR8700 LFIC cores)	MK	
Master keyed (CR8000, CR8020, CR8027, CR8200, CR8500, CR8600, CR8700)	MK-IC	No Charge
Master keyed to customer bittings or sample key	MK-CB	Add \$16.00 per cylinder
Visual Cylinder/Key Control (VKC)		
No stamping except keyway designation (keys will be tagged)	VKCO	No Charge
Keys only	VKC1	N/A
Cylinder and keys*	VKC2	\$4/Cyl
Cylinder*	VKC3	
All VKC, VDC, or VAC stamping codes that use an alternate symbol	AltV	
No stamping except keyway designation (keys will be tagged)	VKCO	\$5/Cyl
Keys only	VKC1	No Charge
Cylinder and keys*	VKC2	
Cylinder*	VKC3	
All VKC, VDC, or VAC stamping codes that use an alternate symbol	AltV	\$4/Cyl
Concealed Cylinder/Visual Key Control (CKC)		
Cylinder and keys*	CKC2	\$4/Cyl
Cylinder*	CKC3	
All CKC, CDC, or CAC stamping codes that use an alternate symbol	AltC	
Cylinder and keys*	CKC2	No Charge
Cylinder*	CKC3	
All CKC, CDC, or CAC stamping codes that use an alternate symbol	AltC	\$4/Cyl

Notes: 1. CMK Construction master keying charge is in addition to master keying charge.
 2. CMK construction master keying is not available in interchangeable core, Access 3, Pyramid, or Security series.
 *For key bows other than 10 and 90, specify "KB" + bow number as Quick Code, e.g. KB12.

Strike Options

To purchase strike separately, see catalog for part no.

Description	Specify	Add or Deduct
Open rim strike on ED7200	(standard)	No Charge
Rim strike	S07	
Rim strike for aluminum frames with blade stops	S08	
Mortised adjustable rim strike	S04	
Vertical rod top strike on ED7400 device	(standard)	
Vertical rod bottom strike on ED7400		
Vertical rod flush bottom strike on ED7400 device	S03	
Concealed vertical rod top strike on ED7800 device	(standard)	
Fire rated concealed vertical rod top strike on ED7800A device	(standard)	
Fire rated concealed vertical rod bottom strike on ED7800 and ED7800A devices	(standard)	

Description	Lip Length	Specify	Add or Deduct
Mortise straight lip ANSI strike on ED7600, ED7600A	1-1/8"	(standard)	No Charge
	1-1/4"	SS114	
	1-3/8"	SS138	
Mortise open back strike	1-3/4"	SB134	Add \$124.00 per device
	2"	SB200	\$197.00
	2-1/4"	SB214	

Door Width Options

Description	Specify	Add or Deduct
36"	(standard)	No Charge
48"	W048	Add \$53.00 per device

Door Thickness Options

Description	Specify	Add or Deduct
1-3/4"	(standard)	No Charge
2" (Not available for ED7800 Series)	D200	
2-1/4" (Not available for ED7800 Series)	D214	

Door Height Options

Description	Specify	Add or Deduct
7'6" (ED7400 devices)	(standard)	No Charge
7'2" (ED7400A & 7800A devices)	(standard)	
8'6" (ED7800 devices)	(standard)	
10'0" (ED7400 devices only)	H1000	Add \$121.00 per device
10'8" (ED7800 devices only)	H1008	

Miscellaneous Options

Description	Specify	Add or Deduct
Spanner head screws	M02	Add \$51.00 per device
ANSI wrought strike box (for mortise only)	M17	No Charge
Knurling outside and inside (trim and device)	M20*	Add \$219.00 per device
Knurling outside only (trim side)	M21*	Add \$105.00 per device
Knurling inside only (device side)	M22*	Add \$114.00 per device
Abrasive coat outside and inside (trim and device)	M23	Add \$135.00 per device
Abrasive coat inside only (device side)	M24	Add \$72.00 per device
Abrasive coat outside only (trim side)	M25	Add \$63.00 per device
Stainless Steel Crossbar ¹		
- When ordered with 626 or 630 finish	M50	No Charge
- All other finishes	M50	Add \$110.00 per device
Less dogging	M51	No Charge
Steel reinforced crossbar	M53	Add \$101.00 per device
Sex nuts and bolts (SNBs)	M54	No Charge
Shim for 2-3/4" backset on doors with 1/2" stop (for ED7200 only)	M59	Add \$32.00 per device
Less latch hold-back (for ED7200 and ED7600 devices only)	M66	No Charge

Note:

1. Not available with M22 or M20 option.

*All levers provided in a powder coat finish will be supplied with an abrasive coating.

Removable Mullion

Ordering Example

Quantity	Mullion Number
10	CR507

Mullion Number	Description	Price
CR510	For doors up to 10'	\$1,242.00

DC3000 Series:

DC3000 Series Standard Features	362
---------------------------------	-----

DC3000 Series Arm Options, Miscellaneous Options, Brackets, Door Thickness, Drop Plates, Finish Options	363
---	-----

DC5200 Cam Action Door Closer:

DC5200 Standard Features	364
--------------------------	-----

DC5200 Arm Options, Door Thickness, Handing, Finish Options, Miscellaneous Options, Drop Plate	365
--	-----

DC6000 Series:

DC6000 Series Standard Features	366
---------------------------------	-----

DC6200 Series, DC6400 Series	367
------------------------------	-----

DC6000 Series Arm Options, Door Width Options, Finish Options, Door Thickness, Handing	368
--	-----

DC6000 Series Miscellaneous Options, Blade Stop Spacer, Miscellaneous Brackets, Drop Plates	369
---	-----

DC8000 Series:

DC8000 Series Standard Features	370
---------------------------------	-----

DC8200 Series (Factory Pre-Sized)	371
-----------------------------------	-----

DC8000 Series Arm Options, Door Width Options, Finish Options	372
---	-----

DC8000 Series Miscellaneous Options, Blade Stop Spacer, Miscellaneous Brackets, Drop Plates	373
---	-----

DC62900 Series:

DC62900 Series Electromechanical Door Controls: Ordering Example, DC62900 Series, Miscellaneous Options, Voltage	374
--	-----

Standard Features

Handing

Non-handed

Spring Power

DC3200 Series: Non-sized
fully adjustable 1 thru 6.

Degree of Opening

Up to 180° opening standard for
regular, top jamb and
parallel arm mounting.

Case Quantity

4

Case Weight

42 lbs

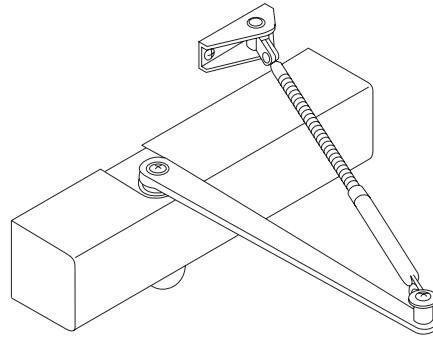

Ordering Examples

Stock Order

Quantity	Series/Mounting	Finish
48	DC3210	689

Contract Order

Quantity	Series/Mounting	Arm	Finish	Option
100	DC3210	A4	689	M54

DC3200 Series

Non-sized: full adjustability from sizes 1-6

Function	Description	Finish: 600, 689, 690, 691, 693, 696
DC3200	Regular arm	\$602.00
DC3210	Parallel arm	
DC3220	Top jamb	

DC3210 closers are tri-packed standard (for regular arm, top jamb or parallel arm mounting) unless specialty arm is requested.

Arm Options

Description	Specify Quick Code	Add or Deduct
Hold open arm	A1	Add \$108.00 per closer
Heavy-duty parallel arm with hold open	A2	Add \$137.00 per closer
Heavy-duty parallel arm	A3	Add \$67.00 per closer
Heavy-duty parallel arm with backstop	A4	Add \$129.00 per closer
Heavy-duty parallel arm with backstop & hold open	A5	Add \$242.00 per closer
Heavy-duty regular arm	A10	Add \$67.00 per closer

Miscellaneous Options

Description	Specify Quick Code	Add or Deduct
Sex nuts and bolts (SNB)	M54	No Charge
Backcheck intensity	(standard)	No Charge
Delayed Action	M71	Add \$63.00 per closer
Full ABS Cover	(standard)	No Charge
Corrosion protection	M75	Add \$57.00 per closer
Heavy-duty parallel arm flush transom bracket (499F30). Used with A2, A3, A4 & A5 arms)	M79	Add \$23.00 per closer

Miscellaneous Brackets

Description	Specify Quick Code	Add or Deduct
Parallel arm flush transom bracket	M82	Add \$44.00 per closer
Parallel arm offset bracket	M83	Add \$44.00 per closer
Mortise arm bracket for regular arm mounting	M84	Add \$44.00 per closer
Angle Support bracket	M85	Add \$44.00 per closer

Door Thickness

Description	Specify
1-3/4"	(standard)

Drop Plates

Closer Plates	Old Quick Ship #	Full Cover	List price
DC3210	M80	597F58	\$109.00
DC3220	M80	188F65	\$109.00

Finish Options

Description	Add or Deduct
600, 613E, 689, 690, 691, 693, 696, BSP, WSP	(standard)

Standard Features Handing

Non-handed

Degree of Opening

Pull Side = 140°, Push Side = 110°

Case Weight

8 lbs.

Spring Power

Sizes 1 thru 6 fully adjustable

Slide Track

Standard



Ordering Example

Stock Order

Quantity	Series/Mounting	Finish
100	DC5200	689

Contract Order

Quantity	Series/Mounting	Arm	Finish
100	DC5200	A1	689

DC5200

Non-sized: full adjustability from sizes 1-6

Function	Description	Finish: 689, 690, 691, 693, 696
DC5200	Push and pull installation, door or frame mounted	\$825.00

Arm Options

Description	Specify Quick Code	Add or Deduct
Hold open arm	A1	\$38.00

Door Thickness

Description	Specify
1-3/4"	(standard)

Handing

Description	Specify
Left Hand	LH
Right Hand	RH
Left Hand Reverse	RH
Right Hand Reverse	LH

Finish Options

Description	Add or Deduct
Painted finishes: 689, 690, 691, 693, 696	(standard)

Miscellaneous Options

Description	Specify Quick Code	Add or Deduct
Torx® Security Screws	M04	Add \$50.00 per closer
Sex nuts and bolts (SNB)	M54	No Charge

Drop Plate

Description	Part Number	Add or Deduct
Drop Plate (Push side)	754F80	\$70.00

Standard Features
Handing

Non-handed

Spring Power

DC6200 Series: sizes 1 thru 6
non-sized fully adjustable.

DC6400 Series: sizes 1 thru 6
half-size adjustability.

Degree of Opening

Up to full 180° opening
standard for regular, top jamb
and parallel arm applications.

Case Quantity

4

Case Weight

DC6200 42 lbs

DC6400 42 lbs

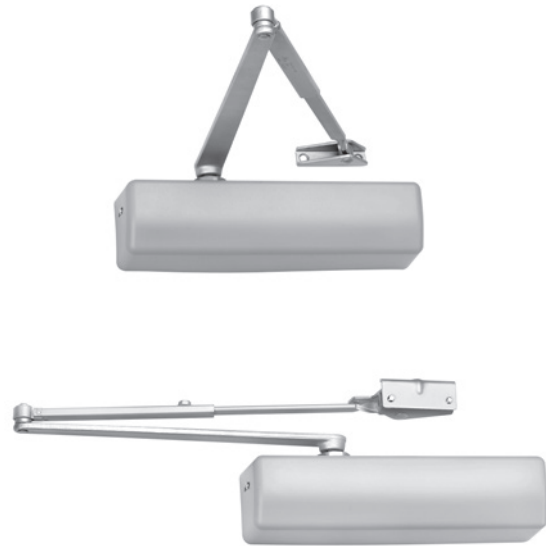

Ordering Example

Stock Order

Quantity	Series/Mounting	Finish
100	DC6210	689

Contract Order

Quantity	Series/Mounting	Arm	Finish	Door Thickness
100	DC6406	A6	689	D138

DC6200 Series

Non-sized: full adjustability from sizes 1-6

Function	Description	Finish: 600, 613E, 689, 690, 691, 693, 696, BSP, WSP
DC6200	Regular arm	\$664.00
DC6210	Parallel arm	
DC6220	Top jamb	
DC6230	Pull side track**	\$764.00
DC6240	Push side track	

DC6210 closers are tri-packed standard (for regular arm, top jamb or parallel arm mounting) unless specialty arm is requested.
 **Minimum 3" top jamb required.

DC6400 Series

Sized: 1/2-size adjustability

Function	Description	Finish: 600, 613E, 689, 690, 691, 693, 696, BSP, WSP
DC6401	Regular arm	Size 1
DC6402		Size 2
DC6403		Size 3
DC6404		Size 4
DC6405		Size 5
DC6406		Size 6
DC6411	Parallel arm	Size 1
DC6412		Size 2
DC6413		Size 3
DC6414		Size 4
DC6415		Size 5
DC6416		Size 6
DC6421	Top jamb	Size 1
DC6422		Size 2
DC6423		Size 3
DC6424		Size 4
DC6425		Size 5
DC6426		Size 6
DC6433	Pull side track	Size 3
DC6434		Size 4
DC6435		Size 5
DC6436		Size 6
DC6443	Push side track	Size 3
DC6444		Size 4
DC6445		Size 5
DC6446		Size 6

Note: See page 368 for plated finishes.
 DC641X closers are tri-packed standard (for regular arm, top jamb or parallel arm mounting) unless specialty arm is requested.

Arm Options		
Description	Specify Quick Code	Add or Deduct
Hold open arm	A1	Add \$108.00 per closer
Heavy-duty parallel arm with hold open	A2	Add \$137.00 per closer
Heavy-duty parallel arm	A3	Add \$67.00 per closer
Heavy-duty parallel arm with backstop	A4	Add \$129.00 per closer
Heavy-duty parallel arm with backstop & hold open	A5	Add \$242.00 per closer
Deep reveal (3-1/4" - 7-1/4")	A6	No Charge
Deep reveal with hold open	A8	Add \$108.00 per closer
Heavy-duty regular arm	A10	Add \$67.00 per closer
Heavy-duty Unitrol®	A11*	Add \$348.00 per closer
Heavy-duty Unitrol® with hold open	A12*	Add \$456.00 per closer
Heavy-duty parallel arm with extra clearance	A13	Add \$70.00 per closer
Heavy-duty friction hold open arm	A14	Add \$136.00 per closer
Push side track with hold open	A1	Add \$108.00 per closer

* Specify door width

Door Width Options		
Description	Specify Quick Code	Add or Deduct
A11, A12 door width 28" - 32"	W28	No Charge
A11, A12 door width 33" - 41"	W33	
A11, A12 door width 42" - 48"	W42	

Finish Options*	
Description	Add or Deduct
	605, 606, 611, 612, 625, 626
Painted finishes: 600, 613E, 689, 690, 691, 693, 696, BSP, WSP	(standard)
Plated finishes: specify 605, 606, 611, 612, 625, 626	
Regular, parallel, hold open:	
- Plated arm & cover*	Add \$786.00 per closer
- Plated cover (metal)	Add \$320.00 per closer
- Plated arm*	Add \$466.00 per closer

Heavy-Duty arms (A2, A3, A4, A5, A10, A11, A12, A13, A14) are not available plated.
 Track & arm for track-type closers are not available plated.

*For split finish of closer cover and arm, specify cover first, then arm finish; e.g. DC6200 x 625 x 689.

Special Finishes	
<ul style="list-style-type: none"> Contact factory for availability 50 piece minimum order for non-standard sprayed or powder coat finishes 	Net add \$55.00 per closer
Additional charge per closer will be added to net/net charge	

Door Thickness	
Description	Specify
1- 3/4"	(standard)
2"	D200

Handing	
Description	Specify
Left Hand	LH
Right Hand	RH
Left Hand Reverse	RH
Right Hand Reverse	LH

Miscellaneous Options

Description	Specify Quick Code	Add or Deduct
Torx® Screws	M04	Add \$50.00 per closer
Sex nuts and bolts (SNB)	M54	No Charge
Backcheck intensity and location valves	(standard)	No Charge
Delayed Action	M71	Add \$63.00 per closer
Full ABS Cover	(standard)	No Charge
Full Metal Cover	M73	Add \$25.00 per closer
Extreme temperature fluid	(standard)	No Charge
Corrosion protection	M75	Add \$57.00 per closer
Security package*	M87	A2-Arm - Add \$212.00 per closer
		A3-Arm - Add \$142.00 per closer
		A4-Arm - Add \$204.00 per closer
		A5-Arm - Add \$317.00 per closer
		A10-Arm - Add \$142.00 per closer

*M87 includes full metal cover, Torx® fasteners and A2, A3, A4, A5, or A10 arm. Specify arm when ordering.

Blade Stop Spacer

Description	Specify Quick Code	Add or Deduct
1/2" spacer (597F92)	M77	Add \$33.00 per closer
5/8" spacer (597F93)	M78	Add \$54.00 per closer

Miscellaneous Brackets

Description	Specify Quick Code	Add or Deduct
HD PA flush transom bracket (used with all parallel arms except the Unicontrol®)	M79	Add \$58.00 per closer
Parallel arm flush transom bracket	M82	Add \$44.00 per closer
Parallel arm offset bracket	M83	Add \$44.00 per closer
Mortise arm bracket for regular arm mounting	M84	Add \$44.00 per closer
Angle support bracket	M85	Add \$44.00 per closer
Deep Reveal Reinforcement Kit	M103	Add \$44.00 per closer
Flush partition bracket	M104	Add \$36.00 per closer
Lead lined cover (metal cover only)	M108	Add \$271.00 per closer

Drop Plates

Closer Plates	Old Quick Ship #	Full Cover	List Price
DC6210, DC6410 (Parallel)	M80	597F58	\$109.00
DC6220, DC6420 (Top Jamb)	M80	188F65	
DC6230, DC6430 (Pull Side)	M81	597F59	
DC6240, DC6440 (Push Side)	M102	597F59	

Standard Features
Handing

Non-handed

Spring Power

DC8200 Series: sizes 1 thru 6
non-sized fully adjustable.

DC8200 Series: sizes 1 thru 6
half-size adjustability.

Degree of Opening

Up to full 180° opening
standard for regular, top jamb
and parallel arm applications.

Case Quantity

4

Case Weight

DC8200 54 lbs



Ordering Example

Stock Order

Quantity	Series/Mounting	Finish
100	DC8210	689

Contract Order

Quantity	Series/Mounting	Arm	Finish	Door Thickness
100	DC8206	A6	689	D138

DC8200 Series				
Non-sized full adjustability from sizes 1-6				
Function	Description	Finish: 600, 613E, 689, 690, 691, 693, 696, BSP, WSP		
DC8200	Regular arm	\$872.00		
DC8210	Parallel arm			
DC8220	Top Jamb			
DC8230	Pull side track**	\$968.00		
DC8240	Push side track			
DC8210 closers are tri-packed standard (for regular arm, top jamb or parallel arm mounting) unless specialty arm is requested. *Minimum 3" top jamb required.				
Factory Pre-Sized (available upon request)				
Function	Description	Finish: 600, 613E, 689, 690, 691, 693, 696, BSP, WSP		
DC8201	Regular arm	Size 1	\$872.00	
DC8202		Size 2		
DC8203		Size 3		
DC8204		Size 4		
DC8205		Size 5		
DC8206		Size 6		
DC8211	Parallel arm	Size 1		
DC8212		Size 2		
DC8213		Size 3		
DC8214		Size 4		
DC8215		Size 5		
DC8216		Size 6		
DC8221	Top Jamb	Size 1		
DC8222		Size 2		
DC8223		Size 3		
DC8224		Size 4		
DC8225		Size 5		
DC8226		Size 6		
DC8233	Pull side track	Size 3	\$968.00	
DC8234		Size 4		
DC8235		Size 5		
DC8236		Size 6		
DC8243	Push side track	Size 3		
DC8244		Size 4		
DC8245		Size 5		
DC8246		Size 6		
DC821X closers are tri-packed standard (for regular arm, top jamb or parallel arm mounting) unless specialty arm is requested.				

Arm Options

Description	Specify Quick Code	Add or Deduct
Hold open arm	A1	Add \$108.00 per closer
Heavy-duty parallel arm with hold open	A2	Add \$137.00 per closer
Heavy-duty parallel arm	A3	Add \$67.00 per closer
Heavy-duty parallel arm with backstop	A4	Add \$129.00 per closer
Heavy-duty parallel arm with backstop & hold open	A5	Add \$242.00 per closer
Deep reveal (3-1/4" - 7-1/4")	A6	No Charge
Deep reveal with hold open	A8	Add \$108.00 per closer
Heavy-duty regular arm	A10	Add \$67.00 per closer
Unitrol® arm	A11*	Add \$348.00 per closer
Unitrol arm x hold open	A12*	Add \$456.00 per closer
Heavy-duty parallel arm with extra clearance	A13	Add \$70.00 per closer
Heavy-duty friction hold open	A14	Add \$136.00 per closer
Push side track with hold open	A1	Add \$108.00 per closer

*Specify door width

Door Width Options

Description	Specify Quick Code	Add or Deduct
A11, A12 - door width 28" - 32"	W28	No Charge
A11, A12 - door width 33" - 41"	W33	
A11, A12 - door width 42" - 48"	W42	

Finish Options*

Description	Add or Deduct
	605, 606, 611, 612, 625, 626
Painted finishes: 600, 613E, 689, 690, 691, 693, 696, BSP, WSP	(standard)
Plated finishes: specify 605, 606, 611, 612, 625, 626	
Regular, parallel, hold open:	
- Plated arm & cover*	Add \$786.00 per closer
- Plated cover (metal)**	Add \$320.00 per closer
- Plated arm*	Add \$466.00 per closer

Heavy-Duty arms (A2, A3, A4, A5, A10, A11, A12, A13, A14) are not available plated.
 Track & arm for track-type closers are not available plated.

*For split finish of closer cover and arm, specify cover first, then arm finish; e.g. DC6200 x 625 x 689.
 **Price of M73 option is not included.

Special Finishes

<ul style="list-style-type: none"> Contact factory for availability 50 piece minimum order for non-standard sprayed or powder coat finishes 	Net add \$55.00 per closer
Additional charge per closer will be added to net/net charge	

Miscellaneous Options		
Description	Specify Quick Code	Add or Deduct
Torx® Screws	M04	Add \$50.00 per closer
Sex nuts and bolts (SNB)	M54	No Charge
Backcheck valve	(standard)	No Charge
Delayed Action	M71	Add \$63.00 per closer
Full ABS Cover	(standard)	No Charge
Full Metal Cover	M73	Add \$25.00 per closer
Extreme Temperature Fluid	(standard)	No Charge
Corrosion Protection	M75	Add \$57.00 per closer
Security Package*	M87	A2-Arm - Add \$212.00 per closer
		A3-Arm - Add \$142.00 per closer
		A4-Arm - Add \$204.00 per closer
		A5-Arm - Add \$317.00 per closer
		A10-Arm - Add \$142.00 per closer
*M87 includes full metal cover, Torx® fasteners and A2, A3, A4, A5, A10 or A13. Specify arm when ordering		
Blade Stop Spacer		
Description	Specify Quick Code	Add or Deduct
1/2" spacer (597F92)	M77	Add \$33.00 per closer
5/8" spacer (597F93)	M78	Add \$54.00 per closer
Miscellaneous Brackets		
Description	Specify Quick Code	Add or Deduct
HD PA flush transom bracket (used with all parallel arms except the Unitrol®)	M79	Add \$58.00 per closer
Parallel arm flush transom bracket	M82	Add \$44.00 per closer
Parallel arm offset bracket	M83	Add \$44.00 per closer
Mortise arm bracket for regular arm mounting	M84	Add \$44.00 per closer
Angle support bracket	M85	Add \$44.00 per closer
Deep reveal reinforcement kit	M103	Add \$44.00 per closer
Flush partition bracket (used with Unitrol® arm)	M104	Add \$36.00 per closer
Lead lined cover	M108	Add \$271.00 per closer
Drop Plates		
Closer Series	Part Number	List Price
DC8200 (regular)	754F20	\$135.00
DC8200 (with concealed holder)	754F24	\$135.00
DC8210 (parallel)	754F25	\$135.00
DC8220 (top jamb)	754F24	\$135.00
DC8230 (pull side track)	754F20	\$135.00

Electromechanical Door Controls

Sex nuts and bolts are furnished standard.
 689 Finish.

Ordering Example

Quantity	Series/Mounting	Finish	Voltage	Options
24	DC62930	689	24A	M54

DC62900 Series

Model	Quick Code	Description		Finish: 689, 690, 691, 693, 696
DC62930	ET	Pull Side	Support Unit	\$1,806.00
DC62940	ET	Push Side	Support Unit	\$1,806.00

Miscellaneous Options

Description	Specify Quick Code	Add or Deduct
Torx® machine screws	M04	Add \$50.00 per closer
Sex nuts and bolts		
- DC62930	(standard)	(standard)
- DC62940	(standard)	(standard)
Backcheck intensity valve	M70	Add \$49.00 per closer

Voltage*

Description	Specify Quick Code
24VAC	24A
24VDC	24D
120VAC	120A

Parts Price List

Number 40
USA & Canada Prices Effective
March 3, 2025



PLUGS AND SHELLS

6-PIN PLUGS, BULK PACKS			606, 626
PART NO.	DESCRIPTION	LIST PRICE	
These packages are priced at a savings over individual plug prices. Keyway availability is limited to L4, D1, H1, 60, 59A1 and 981.			
492K90	25 Pack for 1-1/8" Mortise	\$1,115.00	
492K91	25 Pack for 3000 Rim		
492K92	50 Pack for CK4200, UT5200	\$2,232.00	
610K48	50 Pack for CL3300		
5- AND 6-PIN INDIVIDUAL PLUGS			
X CLASS	STANDARD	USED IN	LIST PRICE
487K10	121K10	1" Mortise (5-pin)	\$56.00
487K11	121K11	1-1/8" Mortise	
606K73	193K09	3-1/4" Mortise	\$100.00
606K74	193K10	3-1/2" Mortise	\$102.00
606K75	193K11	3-3/4" Mortise	\$108.00
487K38	197K51*	1001 Hotel Mortise	\$60.00
488K99	488K98	CK4200, UT5200 (.552") and 2000051	\$56.00
564K53	574K05	CK4400, except below	
564K60	564K52	CK4429 Hotel, old tailpiece	\$71.00
564K59	579K14	CK4429, new tailpiece	
580K99	574K07	CK4455, CK4482, before 8/93	\$56.00
596K29	585K24	CL3300, CL3500, CL3600, CL3700, CL3800	
596K31	585K26	CL3329, CL3629 Hotel	\$73.00
489K49	186K75	2001051 (1429/3433EM)	
534K25	245K37	2100/2160 (large head)	\$71.00
612K90	444K87	2200001 and 009	
612K91	444K89	2200002	
612K88	444K94	2200008	
612K93	444K88	2200054	
612K94	523K21	2200076	\$56.00
488K84	253K66	3000 Rim Cylinder	
610K46	146K80	4200002 for AR Pull	\$71.00
	195K68	4266 for MR Exit Operators	\$84.00
334K01	334K00	80006 Interchangeable Core	\$56.00
n/a	378K18	Fox Police Rim Cyl. (5-pin)	\$84.00
7-PIN PLUGS			606, 626
X CLASS	STANDARD	USED IN	LIST PRICE
487K13	292K95	1-1/4" Mortise	\$60.00
487K15	292K96	1-3/8" Mortise	
487K17	292K97	1-1/2" Mortise	
487K19	292K98	1-3/4" Mortise	\$78.00
487K21	292K99	2" Mortise	\$83.00
606K76	293K00	2-1/4" Mortise	
606K77	293K01	2-1/2" Mortise	
606K78	293K02	2-3/4" Mortise	
606K79	293K03	3" Mortise	\$86.00
596K30	585K25	CL3300 Non-Hotel	\$72.00
596K32	585K27	CL3329 Hotel	\$78.00
488K85	253K67	3000-7 Rim Cylinder	\$60.00
416K08	416K07	8000-7 Core	\$72.00

SECURITY PLUGS (USE IN SECURITY SHELLS ONLY)			
PART NO.	DESCRIPTION	LIST PRICE	
407K63	1-1/8" Mortise	\$86.00	
407K64	1-1/4" Mortise		
415K73	1-3/8" Mortise		
415K74	1-1/2" Mortise	\$97.00	
518K73	1-3/4" Mortise		
518K74	2" Mortise	\$114.00	
518K75	2-1/4" Mortise		
518K76	2-1/2" Mortise		
518K77	2-3/4" Mortise	\$119.00	
409K12*	1011 Mortise Hotel		
408K45	CK4200, UT5200	\$78.00	
585K46	CL3300 Non-Hotel	\$97.00	
444K97	2210001 and 009		
444K98	2210002	\$86.00	
444K96	2210008	\$97.00	
444K99	2210054	\$86.00	
407K65	3010 Rim Cylinder	\$78.00	
483K01	3012 Rim	\$94.00	
446K68	8010 Interchangeable Core	\$72.00	
PYRAMID STANDARD PLUGS			
696K43	Used with 1020	†Order 10-	\$78.00
798K912 x Fin	Used with 1020112	†Order 10-	
696K45	Used with 3020	†Order 10-	
696K46	Used with 2020	†Order 10-	
696K48	Used with 2020	†Order 10-	
696K52	Used with 8020, 8027	†Order 10-	
715K14	Used with 2220	†Order 10-	
PYRAMID SECURITY PLUGS			
716K43	Used with 1027	†Order 10-	\$78.00
798K922 x Fin	Used with 1027112	†Order 10-	
716K45	Used with 3027	†Order 10-	
716K46	Used with 2027 KIL	†Order 10-	
716K48	Used with 2027 KIK	†Order 10-	
716K16	Used with 2227	†Order 10-	
PYRAMID SIDE PIN PLUGS			
628K852 x Fin	Used with 1020114	†Order 10-	\$78.00
628K972 x Fin	Used with 1020112	†Order 10-	
628K872 x Fin	Used with 3020	†Order 10-	
628K902 x Fin	Used with 2020052	†Order 10-	
628K882 x Fin	Used with 202003x	†Order 10-	
628K952 x Fin	Used with 2220	†Order 10-	
629K032 x Fin	Used with 8020, 8027	†Order 10-	
628K992 x Fin	Used with 1027114	†Order 10-	
630K472 x Fin	Used with 1027112	†Order 10-	
629K002 x Fin	Used with 3027	†Order 10-	
629K022 x Fin	Used with 2027052	†Order 10-	
629K012 x Fin	Used with 202703x	†Order 10-	
629K042 x Fin	Used with 2227	†Order 10-	
6-PIN LOADED SHELLS, BULK PACKS			
Finishes available for rim and mortise shells: 605, 606, 612, 613, 625, 626			
493F76	25 Pack for 1000118 Mortise	\$2,081.00	
677F42	25 Pack for 1000114 Mortise		
493F77	25 Pack for 3000 Rim		
493F78	50 Pack for CK4200, UT5200		
610F49	50 Pack for CL3300, CL3700		

*Not available in D1, D2, L1, L2, 752, 852 or A class keyways.
†Sold only in multiples of the number indicated. Price is each.

CYLINDER PARTS

PART NO.	DESCRIPTION	LIST PRICE	SOLD IN MULT. OF		
PYRAMID SHELLS					
695F042 x Fin	Used with 1020114, 1027114, 3020058, 3027058	\$101.00	10+		
695F052 x Fin	Used with 3020, 3027 (Slotted)				
696F502 x Fin	Used with 8020, 8027				
696F472	Used with 2020, 2027 (KIL)	\$92.00			
696F499	Used with 2020, 2027 (KIK)				
715F152	Used with 2220, 2227				
PYRAMID SHELLS - SIDE PINS					
628F922 x Fin	Used with 8020, 8027	\$92.00			
629F062 x Fin	Used with 1020114, 1027114, 3020058, 3027058				
630F482 x Fin	Used with 1020112, 1027112				
628F912	Used with 2020052, 2027052				
628F892	Used with 2020, 2027 (Levers)				
628F962	Used with 2220, 2227 (Competitors)				
629F072 x Fin	Used with 3020, 3027 (Slotted)				
PYRAMID SIDE PINS (VIAL OF 20 PINS)					
630F494	Pyramid Side Pins - Vial Of 20 Pins	\$27.00			
PYRAMID HIGH SECURITY PINS (VIAL OF 100 PINS)					
TOP PINS					
695F257031 - .031"	695F257173 - .173"	\$71.00	1		
695F257047 - .047"	695F257189 - .189"				
695F257063 - .063"	695F257204 - .204"				
695F257078 - .078"	695F257220 - .220"				
695F257094 - .094"	695F257236 - .236"				
695F257110 - .110"	695F257252 - .252"				
695F257126 - .126"	695F257267 - .267"				
695F257141 - .141"	695F257283 - .283"				
695F257157 - .157"	695F257299 - .299"				
BOTTOM PINS					
695F247139 - .139"	695F247218 - .218"				
695F247155 - .155"	695F247234 - .234"				
695F247171 - .171"	695F247250 - .250"				
695F247187 - .187"	695F247265 - .265"				
695F247202 - .202"	695F247281 - .281"				
PYRAMID SECURITY PINS (VIAL OF 100 PINS)					
TOP PINS					
695F252031 - .031"	695F252173 - .173"	\$71.00	1		
695F252047 - .047"	695F252189 - .189"				
695F252063 - .063"	695F252204 - .204"				
695F252078 - .078"	695F252220 - .220"				
695F252094 - .094"	695F252236 - .236"				
695F252110 - .110"	695F252252 - .252"				
695F252126 - .126"	695F252267 - .267"				
695F252141 - .141"	695F252283 - .283"				
695F252157 - .157"	695F252299 - .299"				
BOTTOM PINS					
695F244139 - .139"	695F244218 - .218"				
695F244155 - .155"	695F244234 - .234"				
695F244171 - .171"	695F244250 - .250"				
695F244187 - .187"	695F244265 - .265"				
695F244202 - .202"	695F244281 - .281"				
PINS (SPECIFY SIZE WHERE APPROPRIATE)					
553F482 x length	Vial of 100 bottom pins (L Pins)	\$36.00	1		
553F502 x length	Vial of 100 spool top pins (J Pins)				
553F492 x length	Vial of 100 top pins (= master & Bu) (M Pins)				
546F978	Vial of 1500 construction balls	\$31.00	1		
197F527	Pin, blocking of 1001, 1011 (hotel)	\$3.10	50+		
SECURITY BOTTOM PINS					
407T414242	2L	\$7.40	20+		
407T424242	2R				
407T414270	3L				
407T424270	3R				
407T414298	4L				
407T424298	4R				
407T414326	5L				
407T424326	5R				
407T414354	6L				
407T424354	6R				

PART NO.	DESCRIPTION	LIST PRICE	SOLD IN MULT. OF		
SECURITY MASTER PINS					
407T314097	2L	\$7.40	20+		
407T324097	2R				
407T334097	2S				
407T314125	3L				
407T324125	3R				
407T334125	3S				
407T314153	4L				
407T324153	4R				
407T334153	4S				
SECURITY TOP PINS					
407T434193	Size 1 Long	\$7.40	20+		
407T434158	Size 2 Short				
BUMP-RESISTANT TOP SPOOL PINS (VIAL OF 100 PINS)					
628F107171	Conventional	\$70.00	1		
628F107142	Pyramid A	\$151.00	1		
628F107236	Pyramid C	\$164.00	1		
SPRINGS AND SPRING COVERS					
792F997	Spring, interchangeable core	\$0.30	100+		
603F207	Spring, security and convent				
026F757	Spring, hotel mortise blocking pin				
585F327	Spring, cylinder cap pin for 2000034 type	\$0.40	100+		
314F987	Spring for 2001034 indicator	\$0.30	100+		
217F422	Spring Cover, 5-pin brass	\$0.50	100+		
217F442	Spring Cover, 6-pin brass	\$0.50	100+		
314F887	Spring Cover, 6-pin stainless for most 2000 Series	\$1.00	50+		
217F432	Spring Cover, 7-pin brass	\$0.40	100+		
585F397	Spring Cover for 20000347	\$3.10	10+		
171F468	Spring for 1100 Series Cyl. Head	\$0.30	100+		
697F507	Spring for all Pyramid Cyls	\$0.30	100+		
ACCESS 3 PINS (VIAL OF 100 PINS)					
Bottom Pins (BP)					
763F002213	Bottom AP-0	\$26.00	1		
763F002243	Bottom AP-1				
763F002273	Bottom AP-2				
763F002303	Bottom AP-3				
763F002333	Bottom AP-4				
763F002363	Bottom AP-5				
763F002393	Bottom AP-6				
Master Pins (MP)					
763F012030	Master AP&AS-1	\$13.00	1		
763F012060	Master AP&AS-2				
763F012090	Master AP&AS-3				
763F012120	Master AP&AS-4				
763F012150	Master AP&AS-5				
Top Pin - Bump Resistant					
763F027120	Top-Spool AP-4	\$24.00	1		
763F027150	Top-Spool AP-5				
763F027180	Top-Spool AP-6				
763F027210	Top-Spool AP-7				
763F027240	Top-Spool AP-8				
763F027270	Top-Spool AP-9				
763F027300	Top-Spool AP-10				
Top Pin					
763F012180	Top AP-6			\$26.00	1
763F012210	Top AP/BU-7				
763F012240	Top AP/BU-8				
763F012270	Top AP/BU-9				
Build Up Pins (BU)					
763F012300	BU-10	\$26.00	1		
763F012330	BU-11				
763F012360	BU-12				
CMK Wafer					
763F072	CMK Wafer	\$64.00	1		

†Sold only in multiples of the number indicated. Price is each.

CYLINDER PARTS (CONT'D)

PART NO.	DESCRIPTION	LIST PRICE	SOLD IN MULT. OF	PART NO.	DESCRIPTION	LIST PRICE	SOLD IN MULT. OF
CAMS - CONVENTIONAL AND SECURITY				RETAINERS			
756F507	A01 Cloverleaf	\$9.20	10†	173F798	.020" Plug Retainer-3300/5600,1400/4300	\$4.50	50†
756F517	A02 Straight		10†	368F918	.030" Plug Retainer-3000 and 3010 rim cylinders	\$4.50	20†
756F527	A03		10†	488F928	.032" Plug Retainer-2000052, 044 and 051	\$4.50	20†
756F537	A04		10†	333F998	Plug Retainer, LFIC, CK4400, 2200008, 2020 KIK	\$4.50	100†
756F542	A05 AR4070		5†	655F415	Retainer, LFIC rim tailpiece	\$7.40	10†
756F557	A06		10†	365F958	Retainer, Fox Police rim cylinder	\$9.20	10†
756F567	A07	\$11.00	10†	250F088	Retainer for flex head cylinder	\$4.50	100†
756F582	A62	\$27.00	10†	680F645	Cap for 2000033, 034	\$7.40	10†
756F622	A92	\$7.40	10†	585F312	Cap Pin for 2000034	\$4.50	100†
281F272	A93	\$11.00	10†	219F888	Plug Retainer for 2060052	\$4.50	100†
406F438	Cam for O5 Exit trim	\$19.00	1	LFIC THROW MEMBERS			
CAMS - LFIC VERSION				OTHER LFIC PARTS			
756F507	A01 Cloverleaf	\$9.20	10†	715F892	CK4200, UT5200	\$7.40	1
756F517	A02 Straight	\$9.20		320F442	CK4200, UT5200 Best® knob	\$11.00	1
756F527	A03			631F248	CL3400, CL3600 Series packet (before 6/2000) straight	\$11.00	10†
756F537	A04	\$9.20		379F805	Used with 1030134, 1037134	\$64.00	1
756F542	A05 AR4070	\$9.20		628F825	Used with 1030114, 1037114, 1030138, 1037138, 3030, 3037	\$22.00	1
756F557	A06	\$9.20		628F835	Used with 1030112, 1037112	\$26.00	1
756F567	A07	\$11.00	10	362F153	Padlock	\$15.00	10†
756F582	A62 Straight	\$27.00	10	OTHER MASTER RING CYLINDER PARTS			
756F622	A92	\$7.40	10	522F932	Adapter Bushing for MR	\$115.00	1
362F432	A93	\$15.00	10†	135F108	Backplate, MR rim	\$7.40	10†
MASTER RING				446F572	Control Sleeve for 8000 core	\$24.00	5†
562F402	A61 New Cloverleaf (locks after 5/93)	\$7.40	10†	446F582	Control Sleeve for 8010 core	\$28.00	5†
756F582	A62 Straight	\$27.00	10†	438F428	Mortise Cylinder Cam Screw	\$4.50	100†
121F012	A63	\$7.40	5†	334F128	Mortise Cylinder Cam Plate	\$4.50	20†
135F192	A64	\$11.00	5†	622F698	Security disk for CL3400, CL3600		
025F722	A65 Old Cloverleaf (was 11A)	\$9.20	5†	607F919	Spacer for 6-pin Best type core	\$4.50	20†
TAILPIECES				OTHER MORTISE/RIM CYLINDER PARTS			
444F748	A21	\$4.50	20†	253F758	Backplate, rim cylinder	\$4.50	20†
461F108	A22	\$4.50	10†	438F418	Cam Screw		100†
520F358	A23	\$7.40	10†	488F088	Mortise Cylinder Set Screw Pkt		20†
444F758	A24	\$4.50	10†	021F688	Screw, rim cyl. mounting, 2-9/32"		20†
365F968	A38 (Fox square)	\$6.00	5†	021F718	Screw, rim cyl. mounting, 3-1/8"	\$7.40	10†
329F998	A39 (Fox round)	\$11.00	5†	197F347	Wave Washer for collar	\$6.00	20†
484F958	A41	\$4.50	10†	129F848	Cylinder Nut	\$11.00	1
484F928	A42			OTHER KNOB/LEVER CYLINDER PARTS			
484F918	A43	\$4.50	20†	596F879	Obsolete by new design		
484F968	A44	\$7.40	10†	585F387	2001034 Indicator fork	\$4.50	20†
484F938	A45	\$6.00	10†	585F377	2001034 Stabilizer Pin		20†
484F948	A46	\$7.40	10†	314F997	2001034 Indicator Pin	\$7.40	20†
146F788	A47	\$24.00	1	585F407	20010347 Indicator Pin	\$11.00	1
585F337	For 20010346	\$4.50	20†	585F367	Tailpiece Anchor, 2001034	\$4.50	20†
585F358	For 20010347	\$6.00	10†	041F478	Key, hotel shut-out		50†
622F298	For 20000346	\$6.00	10†	PYRAMID CYLINDER PARTS			
596F898	For 2000038			696F42	Blocking plate	\$7.40	20†
622F308	For 20000336, 20000347	\$4.50	20†	697F50	Tumbler spring	\$4.50	100†
489F028	For 2000051	\$4.50	20†	217F43	Spring cover		100†
682F298	For 20000337			217F44	LFIC Spring cover	100†	
186F748	For 2001051	\$11.00	1	696F51	Control sleeve	\$44.00	10†
622F328	For 2400033			628F932	Control sleeve - Used with 8020, 8027	\$46.00	10
682F398	For 2400034	\$28.00	1				
685F098	For 2400037	\$11.00	1				
616F208	For 2400039	\$11.00	1				
616F218	For 2400039L						
490F558	For 3000138	\$6.00	10†				
253F768	For 3000200	\$4.50	20†				
413F488	For 3000200V	\$6.00	10†				
253F778	For 3000312	\$4.50	20†				
413F498	For 3000312V	\$6.00	10†				
582F298	For 3080114 for exit alarm options M61 & M62	\$7.40	10†				
253F858	For 3080178	\$7.40	10†				
284F138	For 3080318	\$6.00	10†				
599F389	Kit for Sargent® in CL3600	\$16.00	1				
601F229	Kit for Sargent® in CL3400	\$17.00	1				
622F328	For Schlage® cyl. in CL3400/CL3600	\$11.00	5†				
715F108	P21	\$9.20	10†				
715F118	P22						
715F128	P23						

†Sold only in multiples of the number indicated. Price is each.

STANDARD DIAMETER CYLINDER COLLARS

PART NO.	DESCRIPTION	LIST PRICE	SOLD IN MULT. OF	PART NO.	DESCRIPTION	LIST PRICE	SOLD IN MULT. OF
STAMPED COLLARS				SOLID, RECESSED FOR CYLINDER HEAD (Cont'd)			
253F97	Spring collar	\$11.00	10†	654F08	.556" for ED4000/ED5000	\$37.00	1
	605, 606, 612, 613, 618, 619, 622, 625, 626				605, 606, 611, 612, 613, 622, 625, 626, 629, 630		
428F66	2-Piece (was 574 1/2, H)	\$19.00	5† 1	609F37	.650"	\$54.00	1
	605, 606, 612, 613, 618, 619, 622, 625, 626				605, 606, 611, 612, 613, 618, 619, 625, 626		
549F52	.219" Straight (was 154 1/2, H1)	\$11.00	10†	609F38	.850"	\$54.00	1
	605, 606, 612, 613, 618, 619, 622, 625, 626				605, 606, 611, 612, 613, 618, 619, 625, 626		
605F43	.350 Tapered spring collar	\$11.00		134F05	With lip, .510" ED7400, ED7800	\$54.00	1
	605, 606, 612, 613, 618, 619, 622, 625, 626				605, 606, 611, 612, 613, 618, 619, 622, 625, 626		
SPACER FOR FLEXIBLE HEAD CYLINDER				OTHER CYLINDER COLLARS			
370F29	.125" (1/8")	\$60.00	1	416F39	Security .172" (was 95)	\$37.00	1
370F31	.250" (1/4")	\$60.00	1		605, 606, 611, 612, 613, 618, 619, 625, 626		
252F82	.312" (5/16")	\$60.00	1	303F25	Solid .312" (was 571/J)	\$52.00	1
SOLID, RECESSED FOR CYLINDER HEAD					605, 606, 611, 612, 613, 618, 619, 625, 626		
447F41	.031" (was 575 1/4, 910)	\$28.00	1	RIM CYLINDER COLLARS			
	605, 606, 612, 613, 618, 619, 622, 625, 626			Flush Mount (was 151/ R1290)			
270F15	.156"	\$37.00	1	255F53	605, 606, 611, 612, 613, 618, 619, 622, 625, 626	\$28.00	10†
	605, 606, 612, 613, 618, 619, 622, 625, 626						10†
447F42	.172" (was 575 3/8, 9106)	\$28.00	1	422F88	Surface Mount	\$28.00	5†
	605, 606, 612, 613, 618, 619, 622, 625, 626				605, 606, 611, 612, 613, 618, 619, 622, 626, 625		1
610F01	.221" (was 5574 3/4, C)	\$47.00	1	STAMPED COLLARS			
	605, 606, 612, 613, 618, 619, 622, 625, 626			Spring collar			
610F02	.289" (was 5574 1/4, L)	\$47.00	1	654F07	.356" for ED4000/ED5000	\$37.00	1
	605, 606, 611, 612, 613, 618, 619, 625, 626				605, 606, 611, 612, 613, 622, 625, 626, 629, 630		
447F43	.375" (was 575 9/16, 9109)	\$28.00	1	609F36	.500"	\$54.00	1
	605, 606, 611, 612, 613, 618, 619, 625, 626				605, 606, 611, 612, 613, 618, 619, 625, 626		

†Sold only in multiples of the number indicated. Price is each.

MASTER RING CYLINDER COLLARS

PART NO.	DESCRIPTION	LIST PRICE	SOLD IN MULT. OF
SOLID, RECESSED FOR CYLINDER HEAD			
447F44	.031" (was 576 1/4, MR910)	\$37.00	1
	605, 606, 611, 612, 613, 618, 619, 625, 626		
447F45	.172" (was 576 3/8, MR9106)	\$45.00	1
	605, 606, 611, 612, 613, 618, 619, 625, 626		
447F46	.375" (was 576 9/16, MR9109)	\$44.00	1
	605, 606, 611, 612, 613, 618, 619, 625, 626		
SPACERS FOR FLEXIBLE HEAD CYLINDERS			
366F70	.090" tapered	\$19.00	5
370F33	.094"		
370F35	.281"	\$19.00	1
RIM CYLINDER COLLARS			
255F54	(was 151 3/4, T)	\$28.00	1
	605, 606, 612, 613, 619, 625, 626		

PART NO.	DESCRIPTION	LIST PRICE
CYLINDER SERVICE TOOLS		
See main price book		
LOCKSET INSTALLATION TOOLS		
574F158	CK4400 Series Knob Removal Tool	\$4.50
506F57	CK4400 Series Knob Cover Removal Tool	\$11.00
391F658	Knob Release Tool, CK4200, ML2200 †Order 100-	\$4.50

PART NO.	DESCRIPTION	LIST PRICE
ARMORED FRONT		
Finish: 605, 606, 611, 612, 613, 619, 625, 626, 629**, 630**, BSP, WSP		
Deadbolt		
079F00	Armored front, 1-1/4" standard	\$55.00
079F02	Armored front, 1-1/16"	
Deadbolt, latchbolt, aux. latch, toggle		
402F29	Armored front, 1-1/4" standard	\$55.00
402F33	Armored front, 1-1/16"	
Deadbolt, latchbolt, auxiliary latch		
402F30	Armored front, 1-1/4" standard	\$55.00
402F34	Armored front, 1-1/16"	
Deadbolt, latchbolt, toggle		
402F31	Armored front, 1-1/4" standard	\$55.00
402F35	Armored front, 1-1/16"	
Latchbolt, auxiliary latch, toggle		
681F31	Armored front, 1-1/4" standard	\$55.00
681F30	Armored front, 1-1/16"	
681F41	LHB, 1-1/4"	
681F40	LHB, 1-1/16"	
Blank Front		
720F43	Armored front, 1-1/4"	\$55.00
720F46	Armored front, 1-1/16"	
Filler Plate		
334F998	USP Filler, 8" x 1-1/4"	
Deadbolt, latchbolt		
423F54	Armored front, 1-1/4" standard	\$55.00
423F57	Armored front, 1-1/16"	
Latchbolt only		
423F55	Armored front, 1-1/4" standard	\$55.00
423F58	Armored front, 1-1/16"	
Latchbolt, auxiliary latch		
624F49	Armored front, 1-1/4" standard	\$55.00
624F53	Armored front, 1-1/16"	

†Sold only in multiples of the number indicated. Price is each.
 **618, 619 finish provided to match 629, 630.

PART NO.	DESCRIPTION	LIST PRICE
AUXILIARY LATCH		
403F677	Auxiliary latch	\$26.00
AUXILIARY LATCH LEVER		
678F548	Auxiliary latch lever	\$9.20
Auxiliary Latch Lever Spring		
678F677	Auxiliary latch lever spring. †Order 100-	\$4.50
CAP		
700F278	Cap	\$37.00
CYLINDER LATCH LEVER SA		
701F748	Cylinder latch lever	\$4.50
753F098	Cylinder latch lever (functions 72, 73, 75)	
CYLINDER LATCH LEVER STOP		
705F949	Cylinder latch lever stop	\$4.50
CYLINDER SET SCREW BRACKET		
402F738	Cylinder set screw bracket	\$9.20
DEADBOLT		
702F987	Deadbolt	\$64.00
753F697	Deadbolt ML2072	
DEADBOLT SPRING		
701F228	Deadbolt spring †Order 50-	\$4.50
DEADLOCKING LEVER		
602F198	Toggle Functions	\$7.40
624F488	Non-Toggle Functions	
DEADLOCKING LEVER SPRING		
700F907	Deadlocking lever spring	\$4.50
FIXED STOP		
684F559	Fixed stop	\$7.40
HUB ALIGNMENT BRACKET		
404F868	Hub alignment bracket	\$11.00
HUB ALIGNMENT BRACKET SCREW		
269F088	FHUM-PH #8-32 X 3/8" Screw †Order 20-	\$4.50
HUB LEVER		
820F008	Non Panic Egress	\$9.20
820F148	Panic Egress	

PART NO.	DESCRIPTION	LIST PRICE
HUB LEVER SPRING		
820F048	Hub lever spring †Order 10-	\$4.50
HUB SPACER		
684F119	Hub spacer	\$4.50
KNOB HUB		
820F088	Cap Side	\$32.00
820F168	Case Side	
LATCHBOLT		
864F107	Latchbolt Assembly (All functions except ML2080 & ML2090)	\$73.00
864F117	Latchbolt Assembly (ML2080 & ML2090 function only)	\$73.00
LATCH LEVER SPRING		
700F957	Latch lever spring	\$4.50
LEVER HUB		
820F068	Cap side	\$22.00
820F078	Case side	
LEVER RETURN SPRING		
404F858	Lever return spring †Order 20-	\$4.50
LOCKING LEVER		
852F307	ML2017 Locking Lever	\$36.00
852F318	ML2017 Spring	
RETAINING RING		
436F177	Retaining ring †Order 100-	\$4.50
SCREW PACKETS		
Finish: 606, 612, 613, 619		
429F41	Mounting screw pack, standard	\$7.40
488F09	Mounting screw pack, MR option	\$11.00
465F57	Mounting screw pack, M04 (VR)	\$37.00
616F12	Mounting screw pack, MR x M04	
SPACER		
466F229	Spacer	\$4.50
624F439	Spacer	
624F449	Spacer	
SPACER SPRING		
684F129	Spacer spring	\$3.10
SPRINGS		
403F568	Spring	\$15.00
688F017	Spring, kickoff	\$4.50
624F427	Spring	\$6.00

†Sold only in multiples of the number indicated. Price is each.
 **618, 619 finish provided to match 629, 630

PART NO.	DESCRIPTION	LIST PRICE
STOP		
684F055	Stop	\$7.40
STOP LEVERS		
700F708	Stop lever	\$4.50
624F478	Stop lever	\$9.20
681F448	Stop lever	\$4.50
682F018	Stop lever	\$9.20
700F748	Stop lever	\$4.50
753F078	Stop lever	
STOP SCREW		
684F067	Stop screw	\$4.50
STOP SPRING		
685F387	Stop spring	\$4.50
703F997	Stop spring	\$4.50
790F047	Aux Stop Spring	
THUMBTURN LEVER HUB		
624F455	Thumbturn lever hub	\$15.00
TURNPIECE HUB – STANDARD		
813F505	Turnpiece Hub, Standard	\$6.00
TURNPIECE HUB – LARGE		
701F705	Turnpiece Hub, Large	\$11.00
853F865	Turnpiece hub, large (ML2087 RH/RHR)	
853F875	Turnpiece hub, large (ML2087 LH/LHR)	
STRIKES		
605, 606, 611, 612, 613, 619, 625, 626, 629**, 630**		
Latchbolt & Deadbolt - Straight Lip		
236L72M014FIN	7/8" Lip Length	\$54.00
236L72M018FIN	1-1/8" Lip Length	
236L72M020FIN	1-1/4" Lip Length	
236L72M022FIN	1-3/8" Lip Length	
236L72M024FIN	1-1/2" Lip Length	
236L72M028FIN	1-3/4" Lip Length	
236L72M032FIN	2" Lip Length	
236L72M036FIN	2-1/4" Lip Length	
236L720M40FIN	2-1/2" Lip Length	
236L720M44FIN	2-3/4" Lip Length	
236L720M48FIN	3" Lip Length	

PART NO.	DESCRIPTION	LIST PRICE	PART NO.	DESCRIPTION	LIST PRICE
STRIKES (Cont'd)			STRIKE - OPEN BACK		
605, 606, 611, 612, 619, 613, 625, 626, 629**, 630**			605, 606, 611, 612, 613, 619, 625, 626, 629**, 630**		
Latchbolt & Deadbolt - Curved Lip (RH)					
340L60M018FIN	1-1/8" Lip Length	RH	411L63M016FIN	1-3/4" (016) Door	RHR
340L60M020FIN	1-1/4" Lip Length	RH	411L63M018FIN	2" (018) Door	LHR
340L60M022FIN	1-3/8" Lip Length	RH	411L63M020FIN	2-1/4" (020) Door	RHR
340L60M024FIN	1-1/2" Lip Length	RH	411L62M016FIN	1-3/4" (016) Door	LHR
340L60M028FIN	1-3/4" Lip Length	RH	411L62M018FIN	2" (018) Door	RHR
340L60M032FIN	2" Lip Length	RH	411L62M020FIN	2-1/4" (020) Door	LHR
340L60M036FIN	2-1/4" Lip Length	RH	STRIKE - RABBETED FRONT		
340L60M040FIN	2-1/2" Lip Length	RH	605, 606, 611, 612, 613, 619, 625, 626, 629, 630		
340L60M044FIN	2-3/4" Lip Length	RH	318F66	All Functions and Handing	\$295.00
340L60M048FIN	3" Lip Length	RH			
Latchbolt & Deadbolt - Curved Lip (LH)					
340L61M018FIN	1-1/8" Lip Length	LH			
340L61M020FIN	1-1/4" Lip Length	LH			
340L61M022FIN	1-3/8" Lip Length	LH			
340L61M024FIN	1-1/2" Lip Length	LH			
340L61M028FIN	1-3/4" Lip Length	LH			
340L61M032FIN	2" Lip Length	LH			
340L61M036FIN	2-1/4" Lip Length	LH			
340L61M040FIN	2-1/2" Lip Length	LH			
340L61M044FIN	2-3/4" Lip Length	LH			
340L61M048FIN	3" Lip Length	LH			

†Sold only in multiples of the number indicated. Price is each.

**618, 619 finish provided to match 629, 630, except on 1-1/4" length curved lip strike

PART NO.	DESCRIPTION	LIST PRICE
TRIM ALIGNMENT (ADAPTER) PACKETS		
Finish: 605, 606, 611, 612, 613, 619, 625, 626, 629**, 630**		
"P" Escutcheon		
Knob or Lever Trim		
466F73	1-3/8" door	\$88.00
466F74	1-3/4" door	
466F75	2-1/4" door	\$100.00
Half Working Trim		
439F25	1-3/8" door	\$55.00
439F26	1-3/4" door	
439F27	2-1/4" door	
Lever/Knob (GZ/YZ) Half Dummy Trim		
488F31	"P" Escutcheon	\$112.00
Lever/Knob (GZ/YZ) Full Dummy Trim		
854F19	"P" Escutcheon	\$112.00
Knob Half Dummy Trim		
437F28	"P" Escutcheon*	\$112.00
Wrought Knob Half Dummy Trim		
511F52	"P" Escutcheon*	\$100.00
"M" and "N" Escutcheons		
Regularly Furnished with Working Trim		
466F50	1-3/8" door	\$84.00
466F51	1-3/4" door	
466F52	2-1/4" door	
Half Working Trim		
428F32	1-3/8" door	\$54.00
428F33	1-3/4" door	
428F34	2-1/4" door	
Half Dummy Trim		
437F26	Knob*	\$97.00
438F37	Cast Knob*	\$106.00
854F27	Lever/Knob (GZ/YZ)	\$97.00
Full Dummy Trim		
854F15	Lever/Knob (GZ/YZ)	\$97.00

†Sold only in multiples of the number indicated. Price is each.

**618, 619 finish provided to match 629, 630.

*Discontinued product, only available as inventory allows.

PART NO.	DESCRIPTION	LIST PRICE
TRIM ALIGNMENT (ADAPTER) PACKETS (Cont'd)		
Knob or Lever Trim Outside & Blank Escutcheon Inside		
466F45	1-3/8" door	\$64.00
466F46	1-3/4" door	
466F47	2-1/4" door	
Sectional Trim		
Regularly Furnished with Working Trim		No Finish
466F40	1-3/8" door	\$44.00
466F41	1-3/4" door	
466F42	2-1/4" door	
Half Working Trim		
437F40	1-3/8" door	\$44.00
437F41	1-3/4" door	
437F42	2-1/4" door	
Half Dummy Trim		
438F38	Cast Knob*	\$110.00
854F23	Lever/Knob (GZ/YZ)	\$69.00
511F51	Wrought Knob*	\$84.00
Full Dummy Trim		
854F11	Lever/Knob (GZ/YZ)	\$23.00
Inside Adapter Only - Lockbody		
427F06	Knob Half Working Trim*	\$44.00
488F27	Lever/Knob (GZ/YZ) Half Working Trim	\$78.00
Adjustable Locknut Assembly*		No Finish
482F37	Adjustable Locknut Assembly	\$16.00
Adjusting Bolt for Half Lever Trim		No Finish
483F34	1-3/8" door	\$16.00
483F35	1-3/4" door	
483F36	2-1/4" door	
Cylinder Set Screw Packet		No Finish
488F088	Standard †Order 20	\$4.50
488F108	Master Ring	\$4.50
Dowel Screw		No Finish
483F30	for Inside Lever/Knob (GZ/YZ)	\$6.00
Emergency Key		Finish: 619
605F42	for ML2020, ML2030, ML2060	\$9.20
E-Ring		No Finish
427F078	for working half trim adapter. †Order 100-	\$4.50

PART NO.	DESCRIPTION	605, 606, 611, 612, 613, 613E, 618, 619, 625, 626, 629, 630, 722
"R" ESCUTCHEON - CAST		
Blank		
426F52	Outside	
545F79	Inside	
For Cylinder only		
427F45	Outside	
545F88	Inside	
For Grip only		
427F43	Outside	
545F87	Inside	
For Cylinder & Grip		
427F39	Outside	
545F80	Inside	\$347.00
For Thumbturn Lever only		
545F84	Inside-1-3/8" door	
545F86	Inside-2-1/4" door	
545F85	Inside-1-3/4" door	
For Thumbturn Lever & Grip		
545F81	Inside-1-3/8" door	
545F83	Inside-2-1/4" door	
545F82	Inside-1-3/4" door	
For Grip & Emergency Key		
427F47	Outside	
PART NO.	DESCRIPTION	605, 606, 611, 612, 613, 613E, 618, 619, 625, 626, 629, 630, 722
"N" ESCUTCHEON - WROUGHT		
Blank		
544F93	Inside or Outside	
For Cylinder only		
544F80	Inside or Outside	
For Grip only		
544F76	Inside or Outside	
For Cylinder & Grip		
544F77	Inside or Outside	
For Thumbturn Lever only		
544F89	Inside-1-3/4" door	\$192.00
544F92	Inside-1-3/8" door	
544F91	Inside-2-1/4" door	
For Thumbturn Lever & Grip		
544F85	Inside-1-3/4" door	
544F87	Inside-2-1/4" door	
544F88	Inside-1-3/8" door	
For Grip & Emergency Key		
544F79	Outside	

PART NO.	DESCRIPTION	605, 606, 611, 612, 613, 613E, 618, 619, 625, 626, 629, 630, 722
"M" ESCUTCHEON - WROUGHT		
Blank		
383F82	Outside	
545F45	Inside	
For Cylinder only		
488F07	Outside	
751F16	Outside - Master Ring	
545F00	Inside	
751F17	Inside - Master Ring	
For Grip only		
488F04	Outside	
544F95	Inside	
For Cylinder & Grip		
488F05	Outside - Conventional	
557F29	Outside - Master Ring	\$192.00
544F96	Inside - Conventional	
377F80	Inside - Master Ring	
For Thumbturn Lever only		
545F42	Inside-1-3/8" door	
545F43	Inside-1-3/4" door	
545F44	Inside-2-1/4" door	
For Thumbturn Lever & Grip		
544F97	Inside-1-3/8" door	
544F98	Inside-1-3/4" door	
544F99	Inside-2-1/4" door	
For Grip & Emergency Key		
544F94	Outside	
"P" ESCUTCHEON - WROUGHT		
Blank		
544F46	Inside	
384F11	Outside	
For Cylinder only		
488F03	Outside	\$192.00
544F43	Inside	

PART NO.	DESCRIPTION	605, 606, 611, 612, 613, 613E, 618, 619, 626, 625, 629, 630, 722
"P" ESCUTCHEON - WROUGHT		
For Grip only		
488F00	Outside	
544F39	Inside	
For Cylinder & Grip		
488F01	Outside	
544F40	Inside	
For Thumbturn Lever only		
544F14	Inside-1-3/8" door	\$192.00
544F44	Inside-2-1/4" door	
544F45	Inside-1-3/4" door	
For Thumbturn Lever & Grp		
544F13	Inside-1-3/8" door	
544F41	Inside-2-1/4" door	
544F42	Inside-1-3/4" door	
For Grp & Emergency Key		
544F38	Outside	
PART NO.	DESCRIPTION	613E, 630
"V" ESCUTCHEON - CAST		
Blank		
700F80	Outside	
700F40	Inside	
For Cylinder only		
700F83	Outside	
700F43	Inside	
For Grip only		
700F81	Outside	
700F41	Inside	
For Cylinder & Grip		
700F82	Outside	
700F87	Outside - 7P & C6 (Use when collar is required)	\$393.00
700F42	Inside	
700F47	Inside - 7P & C6 (Use when collar is required)	
For Thumbturn Lever only		
700F45	Inside	
For Thumbturn Lever & Grip		
700F44	Inside	
For Grp & Emergency Key		
700F84	Outside	
For Cylinder, Grip & Indicator		
700F86	Outside	
700F46	Inside	
PART NO.	DESCRIPTION	LIST PRICE
Hex Wrench		
No Finish		
264F698	Hex Wrench	\$4.50
Key Plate Packet		
438F90	Key Plate Packet: 605, 606, 611, 612, 613, 619, 625, 626, 629**, 630**	\$38.00

**618, 619 finish provided to match 629, 630.

PART NO.	DESCRIPTION	605, 606, 611, 612, 613, 613E, 625, 626	PART NO.	DESCRIPTION	605, 606, 611, 612, 613, 613E, 625, 626
"GZ" KNOB - CAST*			"YZ" KNOB - CAST*		
Inside Knob			Inside Knob		
854F04		\$282.00	854F09		\$282.00
Outside Knob & Spindle Assembly			Outside Knob & Spindle Assembly		
854F01	for 1-3/4" door	\$282.00	854F06	for 1-3/4" door	\$282.00
854F00	for 1-3/8" door		854F05	for 1-3/8" door	
854F03	for 2-1/4" door		854F08	for 2-1/4" door	

MISCELLANEOUS PARTS

PART NO.	DESCRIPTION	LIST PRICE
Knob Release Tool		No Finish
391F658	Knob Release Tool	\$4.50
Knob Shank Adapter		No Finish
483F118	Knob Shank Adapter	\$11.00
Spring Clip		
377F308	Spring Clip	\$4.50

MORTISE INDICATOR PARTS

PART NO.	DESCRIPTION	LIST PRICE
855F649	Indicator Mechanism Retaining Pad (sectional)	\$5.00
856F049	Indicator Window	
855F619	Indicator Spindle Cam - Thumbturn	\$18.00
855F707	Indicator Spindle Cam - Cylinder / No Input-Blank (1-3/4" door thickness)	
855F697	Indicator Spindle Cam - Cylinder / No Input-Blank (1-3/8" door thickness)	
855F717	Indicator Spindle Cam - Cylinder / No Input-Blank (2-1/4" door thickness)	\$18.00
855F727	Indicator Spindle Cam - Cylinder / No Input-Blank - (door thickness greater than 2-1/4", must specify)	
855F747 x Finish	Indicator Spindle Cam - Coin Turn (1-3/4" door thickness)	\$21.00
855F737 x Finish	Indicator Spindle Cam - Coin Turn (1-3/8" door thickness)	
855F757 x Finish	Indicator Spindle Cam - Coin Turn (2-1/4" door thickness)	
855F767 x Finish	Indicator Spindle Cam - Coin Turn (door thickness greater than 2-1/4", must specify)	
858F241	Indicator Display Assembly - Unlocked/Locked, Green/Red	
858F251	Indicator Display Assembly - Vacant/Occupied, Green/Red	\$83.00
858F261	Indicator Display Assembly - Unlocked Icon/Locked Icon, Green/Red	
858F271	Indicator Display Assembly - Unlocked/Locked, White/Red	
858F281	Indicator Display Assembly - Vacant/Occupied, White/Red	
858F291	Indicator Display Assembly - Unlocked Icon/Locked Icon, White/Red	
865F241	Indicator Display Assembly - Ouvert/Ferme, Green/Red	\$19.00
865F251	Indicator Display Assembly - Libre/Occupee, Green/Red	
855F638	Escutcheon Indicator Backing Plate	\$17.00
855F658	Sectional Indicator Surface Mount Backing Plate	\$17.00
858F517 x Finish	Escutcheon Indicator Screw Pack - Phillips, 1-3/4" Door	\$12.00
858F50M x Finish	Escutcheon Indicator Screw Pack - Phillips, 1-3/8" Door	
858F52M x Finish	Escutcheon Indicator Screw Pack - Phillips, 2" Door	
858F53M x Finish	Escutcheon Indicator Screw Pack - Phillips, 2-1/4" Door	
858F55M x Finish	Escutcheon Indicator Screw Pack - Phillips, 2-1/2" Door	
858F497 x Finish	Sectional Indicator Screw Pack - Phillips & Torx	
858F549	Sectional Indicator Template Kit	\$19.00
855F592 x Finish	Cylinder Plate Only - ML190 (Cylinder not included)	\$121.00
855F582 x Finish	CoinTurn Plate Only - ML193 (Assembly that includes cointurn)	\$118.00
859F052 x Finish	Thumbturn Plate Only - ML194 (Assembly that includes standard thumbturn)	\$121.00
859F062 x Finish	Sectional Thumbturn Plate Only (Assembly that includes ADA thumbturn)	\$147.00
859F072 x Finish	Sectional Thumbturn Plate Only (Assembly that includes T1 thumbturn)	\$121.00
859F082 x Finish	Sectional Thumbturn Plate Only (Assembly that includes T2 thumbturn)	
859F092 x Finish	Sectional Thumbturn Plate Only (Assembly that includes T3 thumbturn)	
855F602 x Finish	Sectional Blank/No Input Plate Only	

PART NO.	DESCRIPTION	605, 606, 611, 612, 613, 613E, 618, 619, 625, 626, 629, 630, 722
"AS" LEVER - CAST		
Inside Lever		
670F37		
Outside Lever & Spindle Assembly		
670F64	for 1-3/8" door	\$304.00
670F73	for 1-3/4" door	
671F09	for 2-1/4" door	
"CS" LEVER - CAST		
Inside Lever		
670F30		
Outside Lever & Spindle Assembly		
670F57	for 1-3/8" door	\$304.00
670F66	for 1-3/4" door	
671F02	for 2-1/4" door	
"DS" LEVER - CAST		
Inside Lever		
670F32	LH/LHR	
670F31	RH/RHR	
Outside Lever & Spindle Assembly		
670F59	for 1-3/8" door	\$304.00
670F68	for 1-3/4" door	
671F04	for 2-1/4" door	
670F58	for 1-3/8" door	
670F67	for 1-3/4" door	
671F03	for 2-1/4" door	
671F03	for 2-1/4" door	
"ES" LEVER - CAST		
Inside Lever		
670F33		
Outside Lever & Spindle Assembly		
670F60	for 1-3/8" door	\$304.00
670F69	for 1-3/4" door	
671F05	for 2-1/4" door	
"LS" LEVER - CAST		
Inside Lever		
670F34		
Outside Lever & Spindle Assembly		
670F61	for 1-3/8" door	\$304.00
670F70	for 1-3/4" door	
671F06	for 2-1/4" door	
"NS" LEVER - CAST		
Inside Lever		
670F36		
Outside Lever & Spindle Assembly		
670F63	for 1-3/8" door	\$304.00
670F72	for 1-3/4" door	
671F08	for 2-1/4" door	
"PS" LEVER - CAST		
Inside Lever		
670F38		
Outside Lever & Spindle Assembly		
670F65	for 1-3/8" door	\$304.00
670F74	for 1-3/4" door	
671F10	for 2-1/4" door	
"RS" LEVER - CAST		
Inside Lever		
670F35		
Outside Lever & Spindle Assembly		
670F62	for 1-3/8" door	\$304.00
670F71	for 1-3/4" door	
671F07	for 2-1/4" door	

PART NO.	DESCRIPTION	605, 606, 611, 612, 613, 613E, 618, 619, 625, 626, 629, 630, 722
"LW" LEVER - WROUGHT		
Inside Lever		
493F31		\$258.00
Outside Lever & Spindle Assembly		
483F79	for 1-3/8" door	\$258.00
483F80	for 1-3/4" door	
483F81	for 2-1/4" door	
"RW" LEVER - WROUGHT		
Inside Lever		
493F34		\$258.00
Outside Lever & Spindle Assembly		
483F82	for 1-3/8" door	\$258.00
483F83	for 1-3/4" door	
483F84	for 2-1/4" door	

PART NO.	DESCRIPTION	LIST PRICE
NYLON BUSHING NO FINISH		
698F22	Nylon Bushing †Order 100-	\$4.50
ROSE PACKET		
445F82	Wrought Rose Packet- (Qty 2) 2-7/8" dia. (C)* 605, 606, 611, 612, 613, 613E, 618, 619, 625, 626, 722	\$111.00
445F83	Wrought Rose Packet- (Qty 2) 3-1/2" dia. (D)* 605, 606, 611, 612, 613, 613E, 618, 619, 625, 626, 722	\$111.00
445F84	Wrought Rose Packet- (Qty 2) 3" square (E)* 605, 606, 611, 612, 613, 613E, 618, 619, 625, 626, 722	\$111.00
447F24	Cast Rose Packet - (Qty 2) 2-7/8" dia. (F) 605, 606, 611, 612, 613E, 618, 619, 625, 626, 629, 630, 722	\$271.00
447F25	Cast Rose Packet- (Qty 2) 2-1/4" dia. (B) 605, 606, 611, 612, 613E, 618, 619, 625, 626, 629, 630, 722	\$139.00
487F08	Wrought Rose Packet- (Qty 2) 2-1/4" dia. (A) 605, 606, 611, 612, 613E, 618, 619, 625, 626, 629, 630, 722	\$111.00
853F05	Wrought Rose Packet- (Qty 2) 2-7/8" dia. (H) 605, 606, 611, 612, 613E, 618, 619, 625, 626, 629, 630, 722	\$111.00

PART NO.	DESCRIPTION	LIST PRICE
ROSE REINFORCEMENT PACKET NO FINISH		
445F869	Rose Reinforcement Packet*	\$11.00
SCREW PACKET		
605, 606, 611, 612, 613, 619, 625, 626, 629, 630		
569F45	For M & P half dummy trim*	\$11.00
429F317	Screw Packet for "N" Surface Mounted Escutcheon	\$16.00
616F088	Lock mounting, spanner	\$16.00
584F46	Escutcheon for 1-3/4" door, spanner	\$9.20
384F03	Escutcheon for 2" - 2-1/4" door, spanner	
616F078	T20 Torx® bit	\$22.00
269F098	Screw 1-32 x 1/4" OHMS-PH †Order 100-	\$4.50
SPACER NO FINISH		
497F528	Spacer for Cast Knob*	\$6.00
SPINDLES NO FINISH		
LxL, KxK, LxK, KxL Spindle		
499F828	1-3/8" door	\$55.00
499F838	1-3/4" door	
499F848	2-1/4" door	

†Sold only in multiples of the number indicated. Price is each.

*Discontinued product, only available as inventory allows.

PART NO.	DESCRIPTION	LIST PRICE
INSIDE SPINDLE FOR HALF LEVER TRIM*		
	(Knob x Knob) Spindle*	
680F348	1-3/8" door	\$28.00
680F358	1-3/4" door	\$9.20
680F368	2-1/4" door	\$20.00
VANDAL RESISTANT SPINDLE & SCREW PACK		
700F65	1-3/4" door	\$26.00
700F66	2" door	
700F67	2 -1/4" door	
THIMBLE PACKET		
432F86	(Qty 2) for wrought escutcheon knob trim designs* 605, 606, 611, 612, 613, 619, 625, 626, 629, 630	
		\$54.00
445F85	(Qty 2) for sectional knob trim designs* 605, 606, 611, 612, 613, 619, 625, 626	
		\$67.00
THIMBLE WRENCH NO FINISH		
300F688	Thimble Wrench	\$6.90
THROUGHBOLT PACKET		
	605, 606, 611, 612, 613, 619, 625, 626, 629, 630	
	"M" and "P" Escutcheons	
433F76	1-3/8" door	\$11.00
433F77	1-3/4" door	
433F78	2-1/4" door	
	"R" Escutcheon	
439F33	1-3/8" door	\$11.00
439F34	1-3/4" door	
439F35	2-1/4" door	
	"T" Escutcheon (spanner head)*	
445F318	1-3/4" door	\$24.00
498F928	2" to 2-1/4" door	
THUMBTURN LEVER PACKET		
	605, 606, 611, 612, 613, 625, 626, 629, 630	
519F09	for 1-3/8" door	\$73.00
519F10	for 1-3/4" door	
519F11	for 2-1/4" door	
519F12	for up to 3" door	\$96.00
581F96	for up to 3-1/2" door	
696F39	Blank Plate	
ERGONOMIC THUMBTURN LEVER PACKET FOR SECTIONAL TRIM		
	605, 606, 611, 612, 613, 619, 625, 626, 629, 630	
707F57	for 1-3/8" door	\$108.00
707F58	for 1-3/4" to 2" doors	
707F59	for 2-1/4" door	
707F60	for up to 3" door	
706F70	for up to 4" door	

*Discontinued product, only available as inventory allows.

PART NO.	DESCRIPTION	LIST PRICE
ERGONOMIC THUMBTURN KIT FOR ESCUTCHEON TRIM		
	605, 606, 611, 612, 613, 619, 625, 626, 629, 630	
711F002	for up to 4" door (must be field cut to size)	\$108.00
WASHER FOR VANDAL RESISTANT TRIM		
700F378	Washer	\$6.00
RETAINING RING FOR VANDAL RESISTANT TRIM		
700F168	Retaining ring	\$4.50
LEVER SPINDLE SPRING FOR VANDAL RESISTANT TRIM		
700F367	Lever spindle spring	\$4.50

PART NO. X FINISH	DESCRIPTION	605, 606, 611, 612, 613, 613E, 618, 619, 625, 626, 629, 630, 722
M19 OPTION INDICATORS – KEYED FUNCTION (SECURE)		
720F21	for 1-3/8" (35mm) door	\$183.00
720F22	for 1-3/4" (44mm) – 2" (51mm) door	
720F24	for 2-1/4" (57mm) door	
720F25	for over 2-1/4" (57mm) door	
M19 OPTION INDICATORS – KEYED FUNCTION (VACANT)		
741F21	for 1-3/8" door	\$183.00
741F22	for 1-3/4" to 2" doors	
741F23	for 2-1/4" door	
741F24	for up to 3" door	
M19 OPTION INDICATORS – NON-KEYED FUNCTION (SECURE)		
721F16	for 1-3/8" (35mm) door	\$179.00
721F17	for 1-3/4" (44mm) – 2" (51mm) door	
721F18	for 2-1/4" (57mm) door	
721F19	for over 2-1/4" (57mm) door	
M19 OPTION INDICATORS – NON-KEYED FUNCTION (VACANT)		
720F61	for 1-3/8" (35mm) door	\$179.00
720F62	for 1-3/4" (44mm) – 2" (51mm) door	
720F64	for 2-1/4" (57mm) door	
720F65	for over 2-1/4" (57mm) door	
M19 OPTION THUMBTURN INDICATOR		
723F69	for 1-3/8" (35mm) door	\$317.00
723F26	for 1-3/4" (44mm) – 2" (51mm) door	
791F59	for 2-1/4" (57mm) door	
791F60	for over 2-1/4" (57mm) door	

VINEYARD™ COLLECTION TRIM

PART NO.	DESCRIPTION	605 , 606, 613E, 619, 625, 626
INSIDE LEVERS		
692F632	Frascati LH/LHR	\$399.00
692F642	Frascati RH/RHR	
692F662	Zinfandel LH/LHR	
692F672	Zinfandel RH/RHR	
692F652	Merlot	
OUTSIDE LEVERS		
692F762	Frascati for 1 3/4" door LH/LHR	\$399.00
692F752	Frascati for 1 3/4" door RH/RHR	
692F952	Zinfandel for 1 3/4" door LH/LHR	
692F942	Zinfandel for 1 3/4" door RH/RHR	
692F932	Merlot for 1 3/4" door	
L ESCUTCHEON - CAST		
Blank		
692F862	Inside	\$329.00
For Cylinder Only		
694F322	Inside	
694F522	Outside	
For Grip Only		
694F312	Inside	
694F442	Outside	
For Cylinder & Grip		
694F332	Inside	
694F562	Outside	
For Thumbturn Lever Only		
694F352	Inside	
For Thumbturn Lever & Grip		
694F392	Inside	
For Grip & Emergency Key		
694F482	Outside	
For Grip x Plug Only		
694F682	Outside	
ROSES (PAIR)		
694F802	G-Rose (All functions)	\$373.00

LOCKSET PARTS

PART NO.	DESCRIPTION	LIST PRICE
LEVERS-Finish: 605,606,611,612,613,613E,613L,618,619,625,626,722,BSP,WSP		
790F215	NZ - Plain	\$130.00
790F225	NZ - Cylinder or Button	
790F235	NZ - Emergency Key Hole	
790F245	NZ - Intruder	
790F335	NZ - Sargent® Cylinder Cutout	
790F345	NZ - Sargent Cylinder Cutout - Intruder	
790F395	NZ - Corbin Russwin LFIC - 6 Pin	
790F405	NZ - Corbin Russwin LFIC - 6 Pin Intruder	
790F415	NZ - Corbin Russwin LFIC - 7 Pin	
790F425	NZ - Corbin Russwin LFIC - 7 Pin Intruder	
790F515	NZ - SFIC Cutout	
790F525	NZ - SFIC Cutout Intruder	
790F575	NZ - Schlage® LFIC Cutout	
790F585	NZ - Schlage® LFIC Cutout - Intruder	
790F225	NZ - ASSA ABLOY ACCENTRA™ Cylinder Cutout 6/7 Pin	
790F245	NZ - ASSA ABLOY ACCENTRA™ Cylinder Cutout 6/7 Pin - Intruder	
774F925	NZ - ASSA ABLOY ACCENTRA™ LFIC Cutout 6 Pin	
798F295	NZ - ASSA ABLOY ACCENTRA™ LFIC Cutout 6 Pin - Intruder	
774F945	NZ - ASSA ABLOY ACCENTRA™ LFIC Cutout 7 Pin	
798F305	NZ - ASSA ABLOY ACCENTRA™ LFIC Cutout 7 Pin - Intruder	
780F215	NZ - Security - Plain	
780F225	NZ - Security - Cylinder or Button	
780F235	NZ - Security - Emergency Key Hole	
780F245	NZ - Security - Intruder	
780F335	NZ - Security - Sargent Cylinder Cutout	
780F345	NZ - Security - Sargent Cylinder Cutout - Intruder	
780F395	NZ - Security - Corbin Russwin LFIC - 6 Pin	
780F405	NZ - Security - Corbin Russwin LFIC - 6 Pin Intruder	
780F415	NZ - Security - Corbin Russwin LFIC - 7 Pin	
780F425	NZ - Security - Corbin Russwin LFIC - 7 Pin Intruder	
780F515	NZ - Security - SFIC Cutout	
780F525	NZ - Security - SFIC Cutout Intruder	
780F575	NZ - Security - Schlage® LFIC Cutout	
780F585	NZ - Security - Schlage® LFIC Cutout - Intruder	
776F215	AZ - Plain	
776F225	AZ - Cylinder or Button	
776F235	AZ - Emergency Key Hole	
776F245	AZ - Intruder	
776F335	AZ - Sargent® Cylinder Cutout	
776F345	AZ - Sargent Cylinder Cutout - Intruder	
776F395	AZ - Corbin Russwin LFIC - 6 Pin	
776F405	AZ - Corbin Russwin LFIC - 6 Pin Intruder	
776F415	AZ - Corbin Russwin LFIC - 7 Pin	
776F425	AZ - Corbin Russwin LFIC - 7 Pin Intruder	
776F515	AZ - SFIC Cutout	
776F525	AZ - SFIC Cutout Intruder	
776F575	AZ - Schlage® LFIC Cutout	
776F585	AZ - Schlage® LFIC Cutout - Intruder	
777F215	AZ Security - Plain	
777F225	AZ Security - Cylinder or Button	
777F235	AZ Security - Emergency Key Hole	
777F245	AZ Security - Intruder	
777F335	AZ Security - Sargent Cylinder Cutout	
777F345	AZ Security - Sargent Cylinder Cutout - Intruder	
777F395	AZ Security - Corbin Russwin LFIC - 6 Pin	
777F405	AZ Security - Corbin Russwin LFIC - 6 Pin Intruder	
777F415	AZ Security - Corbin Russwin LFIC - 7 Pin	
777F425	AZ Security - Corbin Russwin LFIC - 7 Pin Intruder	
777F515	AZ Security - SFIC Cutout	
777F525	AZ Security - SFIC Cutout Intruder	
777F575	AZ Security - Schlage® LFIC Cutout	
777F585	AZ Security - Schlage® LFIC Cutout - Intruder	

PART NO.	DESCRIPTION	LIST PRICE
LEVERS-Finish: 605,606,611,612,613,613E,613L,618,619,625,626,722,BSP,WSP		
778F215	PZ - Plain	\$130.00
778F225	PZ - Cylinder or Button	
778F235	PZ - Emergency Key Hole	
778F245	PZ - Intruder	
778F335	PZ - Sargent® Cylinder Cutout	
778F345	PZ - Sargent Cylinder Cutout - Intruder	
778F395	PZ - Corbin Russwin LFIC - 6 Pin	
778F405	PZ - Corbin Russwin LFIC - 6 Pin Intruder	
778F415	PZ - Corbin Russwin LFIC - 7 Pin	
778F425	PZ - Corbin Russwin LFIC - 7 Pin Intruder	
778F515	PZ - SFIC Cutout	
778F525	PZ - SFIC Cutout Intruder	
778F575	PZ - Schlage® LFIC Cutout	
778F585	PZ - Schlage® LFIC Cutout - Intruder	
778F225	PZ - ASSA ABLOY ACCENTRA™ Cylinder Cutout 6/7 Pin	
778F245	PZ - ASSA ABLOY ACCENTRA™ Cylinder Cutout 6/7 Pin - Intruder	
774F965	PZ - ASSA ABLOY ACCENTRA™ LFIC Cutout 6 Pin	
798F395	PZ - ASSA ABLOY ACCENTRA™ LFIC Cutout 6 Pin - Intruder	
774F985	PZ - ASSA ABLOY ACCENTRA™ LFIC Cutout 7 Pin	
798F405	PZ - ASSA ABLOY ACCENTRA™ LFIC Cutout 7 Pin - Intruder	
779F215	PZ Security - Plain	
779F225	PZ Security - Cylinder or Button	
779F235	PZ Security - Emergency Key Hole	
779F245	PZ Security - Intruder	
779F335	PZ Security - Sargent Cylinder Cutout	
779F345	PZ Security - Sargent Cylinder Cutout - Intruder	
779F395	PZ Security - Corbin Russwin LFIC - 6 Pin	
779F405	PZ Security - Corbin Russwin LFIC - 6 Pin Intruder	
779F415	PZ Security - Corbin Russwin LFIC - 7 Pin	
779F425	PZ Security - Corbin Russwin LFIC - 7 Pin Intruder	
779F515	PZ Security - SFIC Cutout	
779F525	PZ Security - SFIC Cutout Intruder	
779F575	PZ Security - Schlage® LFIC Cutout	
779F585	PZ Security - Schlage® LFIC Cutout - Intruder	

PART NO.	DESCRIPTION	LIST PRICE
ROSES		
D ROSE		
678F252 Fin	626/613E, BSP, WSP	\$73.00
	605,606,611,612,613,613L,618,619,625,722	
C ROSE		
779F97 Fin	626/613E, BSP, WSP	\$73.00
	605,606,611,612,613,613L,618,619,625,722	
ROSETTE FOR C & K ROSE		
778F90 Fin	626/613E, BSP, WSP	\$73.00
	605,606,611,612,613,613L,618,619,625,722	
E ROSE		
779F98 Fin	626/613E, BSP, WSP	\$73.00
	605,606,611,612,613,613L,618,619,625,722	
ROSETTE FOR E ROSE		
778F97 Fin	626/613E, BSP, WSP	\$73.00
	605,606,611,612,613,613L,618,619,625,722	
K ROSE		
779F99 Fin	626/613E, BSP, WSP	\$73.00
	605,606,611,612,613,613L,618,619,625,722	

LOCKSET PARTS

PART NO.	DESCRIPTION	LIST PRICE
LATCH ASSEMBLIES		
Standard		
780F81 Fin	10 Function	\$240.00
780F82 Fin	32, 40NT, 51, 52, 55, 57, 62, 72, and 80 Functions	
780F83 Fin	20 and 20H Functions	
780F84 Fin	29, 75, and 93 Functions	
780F85 Fin	61 Function	
3-3/4" Backset		
780F86 Fin	10 Function	\$240.00
780F87 Fin	32, 40NT, 51, 52, 55, 57, 62, 72, and 80 Functions	
780F88 Fin	20 and 20H Functions	
780F89 Fin	29, 75, and 93 Functions	
780F90 Fin	61 Function	
5" Backset		
780F91 Fin	10 Function	\$240.00
780F92 Fin	32, 40NT, 51, 52, 55, 57, 62, 72, and 80 Functions	
780F93 Fin	20 and 20H Functions	
780F94 Fin	29, 75, and 93 Functions	
780F95 Fin	61 Function	
3/4" Throw Fire Latch		
780F96 Fin	10, 51, 55, 57, 72, and 80 Functions	\$311.00

PART NO.	DESCRIPTION	LIST PRICE
STRIKES		
586L19	Curved Lip "T" Strike	\$37.00

PART NO.	DESCRIPTION	LIST PRICE
SLEEVE ASSEMBLIES		
STANDARD		
775F808	Outside Sleeve - 61 Function	\$257.00
776F002 Fin	Inside Sleeve - 51 Function	\$135.00
776F012 Fin	Inside Sleeve - 93 Function	
776F022 Fin	Inside Sleeve - 61 Function	
776F032 Fin	Inside Sleeve - 29 Function	\$257.00
776F042 Fin	Inside Sleeve - 20, 20H and 75 Functions	\$334.00
776F638	Outside Sleeve - 51,57,61,72, and 93 Functions	\$257.00
776F648	Outside Sleeve - 40NT Function	\$135.00
776F658	Outside Sleeve - 32 Function	\$240.00
776F668	Outside Sleeve - 55 and 62 Functions	
776F678	Outside Sleeve - 29 Function	\$257.00
776F688	Outside Sleeve - 52 and 75 Functions	\$286.00
776F698	Outside Sleeve - 20 and 20H Functions	\$217.00
776F708	Inside Sleeve - 10, 55, and 80 Functions	\$118.00
	Outside Sleeve - 10 Function	
776F848	Inside Sleeve - 52 and 72 Functions	\$334.00
776F858	Inside Sleeve - 32 Function	\$240.00
776F868	Inside Sleeve - 62 Function	
776F878	Inside Sleeve - 40NT and 57 Functions	

PART NO.	DESCRIPTION	LIST PRICE
SLEEVE ASSEMBLIES		
INTERCHANGEABLE CORE		
775F818	Outside Sleeve - 61 Function	\$257.00
776F718	Outside Sleeve - 51, 57, 72, 93 Functions	
776F728	Outside Sleeve - 32 Function	\$240.00
776F738	Outside Sleeve - 55, 62 Functions	
776F748	Outside Sleeve - 52, 75 Functions	\$286.00
776F918	Inside Sleeve - 61, 75 Functions	\$257.00
776F928	Inside Sleeve - 52, 72 Functions	\$240.00
776F938	Inside Sleeve - 32 Function	
776F948	Inside Sleeve - 62 Function	\$236.00
3/4" THROW FIRE LATCH - STANDARD		
779F638	Outside Sleeve - 51, 57, 72 Functions	\$240.00
779F648	Outside Sleeve - 55 Function	
779F658	Inside Sleeve - 72 Function	\$124.00
	Inside Sleeve - 57 Function	
779F728	Inside Sleeve - 72 Function	\$334.00
779F738	Inside Sleeve - 57 Function	\$118.00
779F748	Inside Sleeve - 51 Function	\$240.00
3/4" THROW FIRE LATCH - INTERCHANGEABLE CORE		
779F758	Inside Sleeve - 72 Function	\$257.00
M111 SLEEVE ASSEMBLIES - STANDARD		
775F828	Outside Sleeve - 61 Function	\$257.00
776F758	Outside Sleeve - 51, 57, 72, 93 Functions	
776F768	Outside Sleeve - 32 Function	\$240.00
776F778	Outside Sleeve - 55, 62 Functions	
776F788	Outside Sleeve - 29 Function	\$257.00
776F798	Outside Sleeve - 52, 75 Functions	\$286.00
776F958	Inside Sleeve - 52, 72 Functions	\$334.00
776F968	Inside Sleeve - 32 Function	\$240.00
776F978	Inside Sleeve - 62 Function	
M111 SLEEVE ASSEMBLIES - INTERCHANGEABLE CORE		
775F838	Outside Sleeve - 61 Function	\$257.00
776F808	Outside Sleeve - 51,57,61,72,93 Functions	
776F818	Outside Sleeve - 32 Function	\$240.00
776F828	Outside Sleeve - 55, 62 Functions	
776F838	Outside Sleeve - 52, 75 Functions	\$286.00
776F988	Inside Sleeve - 52, 72 Functions	\$240.00
776F998	Inside Sleeve - 32 Function	
777F208	Inside Sleeve - 62 Function	

PART NO.	DESCRIPTION	LIST PRICE
COLLARS		
778F888	Inside Collar	\$15.00
778F898	Outside Collar	\$15.00

PART NO.	DESCRIPTION	LIST PRICE
TAILPIECES		
778F788	Schlage® Fixed Core	\$28.00
780F658	SFIC Core	\$9.20
775F948	SARGENT Fixed Core	\$28.00
780F662	Schlage® LFIC	\$37.00
631F288	Corbin Russwin LFIC	\$9.20
774F878	ASSA ABLOY ACCENTRA™ LFIC 6-Pin	\$3.10
774F888	ASSA ABLOY ACCENTRA™ LFIC 7-Pin	
780F808	Tail, Cylinder, 20H	\$4.50

LOCKSET PARTS

PART NO.	DESCRIPTION	LIST PRICE
MISCELLANEOUS		
778F638	Collar/Rosette Installation Wrench	\$15.00
780F638	Allen Key Wrench	
780F208	M111 Screwdriver	\$9.20
604F228 Fin	Screw Packet	\$11.00
775F908 Fin	Mounting Kit Packet (CL3150)	\$36.00
775F918 Fin	Mounting Kit Packet (CL3170)	
753F598	Rose Installation Tool	\$11.00
778F868	Aligning Pin	\$4.50
779F787	Bearing Assembly	\$319.00
778F812	Emergency Release Cylinder	\$73.00
206F578	Screw, combo #8 PH	\$4.50
790F988	Inside Mounting Flange Assembly	\$184.00
790F998	Outside Mounting Flange Assembly	
403F302 Fin	Cup Washer	\$6.00
305F318 Fin	Machine Screw 1/4-20 x 2-3/4"	\$7.40
269F808	Countersunk Flat Head Screw 10-24x3/8" (1-3/4" Door)	\$4.50
778F968	Anchor Plate	\$4.50
778F91 Fin	Rosette Plug	\$63.00
790F988	Flange SA, Mounting I/S	\$184.00
790F998	Flange SA, Mounting O/S	
220F718	Screw, FHM-PH, 10-24X1/2"	\$4.50
779F797	Bearing SA, D200	\$319.00
779F807	Bearing SA, M16	\$282.00
790F208	Screw, FHM-PH, #4-40X1/2"	\$7.40
679F818	Emergency Release Tool	\$4.50
778F759	Cylinder Spacer for 6-Pin Fixed Core Corbin Russwin or ASSA ABLOY ACCENTRA™ Cylinder	

LOCKSET PARTS

MECHANICAL LOCKBODY ASSEMBLY, FREEWHEELING LEVER – ALL CYLINDER/CORE PREPS (ALL BACKSETS EXCEPT 2-3/8")		
STANDARD/ FREEWHEELING	FUNCTION	LIST PRICE
861F708	CLX3310	\$296.00
861F748 Fin	CLX3320, CLX3320H, CLX3330, CLX3340	
861F728 Fin	CLX3320TO	
861F768 Fin	CLX3329	
861F968	CLX3332	
861F358	CLX3340NT, CLX3357	
861F828 Fin	CLX3351, CLX3393	
861F848	CLX3352, CLX3355	
861F868	CLX3359	
861F788 Fin	CLX3361	
861F988	CLX3362	
862F008	CLX3372	
861F888 Fin	CLX3375	
861F908 Fin	CLX3376	
861F718	CLX3380, CLX3390	
861F928	CLX3381	
862F028	CLX3382	
861F948	CLX3383	
MECHANICAL LOCKBODY ASSEMBLY – RIGID LEVER, ALL CYLINDER/CORE PREPS (ALL BACKSETS EXCEPT 2-3/8")		
RIGID LEVER	FUNCTION	LIST PRICE
861F758 Fin	CLX3320, CLX3320H, CLX3330, CLX3340	\$296.00
861F738 Fin	CLX3320TO	
861F778 Fin	CLX3329	
861F978	CLX3332	
861F368	CLX3340NT, CLX3357	
861F838 Fin	CLX3351, CLX3393	
861F858	CLX3352, CLX3355	
861F878	CLX3359	
861F798 Fin	CLX3361	
861F998	CLX3362	
862F018	CLX3372	
861F898 Fin	CLX3375	
861F918 Fin	CLX3376	
861F938	CLX3381	
862F038	CLX3382	
861F958	CLX3383	

MECHANICAL LOCKBODY ASSEMBLY, FREEWHEELING LEVER – ALL CYLINDER/CORE PREPS (2-3/8" BACKSET ONLY)		
STANDARD/ FREEWHEELING (B238 ONLY)	FUNCTION	LIST PRICE
866F028	CLX3310	\$296.00
866F068 Fin	CLX3320, CLX3320H, CLX3330, CLX3340	
866F048 Fin	CLX3320TO	
866F088 Fin	CLX3329	
866F268	CLX3332	
861F378	CLX3340NT, CLX3357	
866F128 Fin	CLX3351, CLX3393	
866F148	CLX3352, CLX3355	
866F168	CLX3359	
866F108 Fin	CLX3361	
866F288	CLX3362	
866F308	CLX3372	
866F188 Fin	CLX3375	
866F208 Fin	CLX3376	
866F038	CLX3380, CLX3390	
866F228	CLX3381	
866F328	CLX3382	
866F248	CLX3383	
MECHANICAL LOCKBODY ASSEMBLY – RIGID LEVER, ALL CYLINDER/CORE PREPS (2-3/8" BACKSET ONLY)		
RIGID LEVER (B238 ONLY)	FUNCTION	LIST PRICE
866F078 Fin	CLX3320, CLX3320H, CLX3330, CLX3340	\$296.00
866F058 Fin	CLX3320TO	
866F098 Fin	CLX3329	
866F278	CLX3332	
861F388	CLX3340NT, CLX3357	
866F138 Fin	CLX3351, CLX3393	
866F158	CLX3352, CLX3355	
866F178	CLX3359	
866F118 Fin	CLX3361	
866F298	CLX3362	
866F318	CLX3372	
866F198 Fin	CLX3375	
866F218 Fin	CLX3376	
866F238	CLX3381	
866F338	CLX3382	
866F258	CLX3383	

ELECTRIFIED LOCKBODY ASSEMBLY (1-3/8" – 2-1/4" DOOR)		
PART NO.	FUNCTION	LIST PRICE
886F000	Std/Freewheeling – CLX33903, CLX33905	\$720.00
886F010	Rigid Lever – CLX33903, CLX33905	

LOCKSET PARTS

TAILPIECE PACKS – USED WITH MECHANICAL FUNCTIONS		
PART NUMBER	DESCRIPTION	LIST PRICE
862F998	Corbin Russwin & ASSA ABLOY ACCENTRA™ fixed core cylinder tailpiece pack, 6-pin, 1-3/8" - 2" door	\$37.00
863F008	Corbin Russwin & ASSA ABLOY ACCENTRA™ fixed core cylinder tailpiece pack, 6-pin, 2-1/4" door	
863F018	Corbin Russwin & ASSA ABLOY ACCENTRA™ fixed core cylinder tailpiece pack, 7-pin, 1-3/8" - 2" door	
863F028	Corbin Russwin & ASSA ABLOY ACCENTRA™ fixed core cylinder tailpiece pack, 7-pin, 2-1/4" door	
864F568	Hotel cylinder tailpiece, 6-pin, all doors	
864F578	Hotel cylinder tailpiece, 7-pin, all doors	
863F038	Schlage® & SARGENT keyway fixed core cylinder tailpiece pack, 1-3/8" - 2" door	\$11.00
863F048	Schlage® & SARGENT keyway fixed core cylinder tailpiece pack, 2-1/4" door	
863F058	Corbin Russwin LFIC tailpiece pack, 6- or 7-pin, 1-3/8" - 2" door	
863F068	Corbin Russwin LFIC tailpiece pack, 6- or 7-pin, 2-1/4" door	\$37.00
864F568	Hotel LFIC tailpiece pack, 6-pin, all doors	
864F578	Hotel LFIC tailpiece pack, 7-pin, all doors	\$11.00
863F078	SFIC tailpiece pack, 6-or7-pin, 1-3/8" - 2" door	
863F088	SFIC tailpiece pack, 6-or7-pin, 2-1/4" door	\$28.00
862F978	SARGENT fixed core tailpiece pack, 6-pin, 1-3/8" - 2" door	
862F988	SARGENT fixed core tailpiece pack, 6-pin, 2-1/4" door	\$37.00
863F038	Schlage® fixed core tailpiece pack, 6-pin, 1-3/8" - 2" door	
863F048	Schlage® fixed core tailpiece pack, 6-pin, 2-1/4" door	
862F472	Schlage® LFIC tailpiece pack, 6-pin, 1-3/8" - 2" door	
862F482	Schlage® LFIC tailpiece pack, 6-pin, 2-1/4" door	
862F402	ASSA ABLOY ACCENTRA™ LFIC tailpiece pack, 6-pin, 1-3/8" - 2" door	
862F412	ASSA ABLOY ACCENTRA™ LFIC tailpiece pack, 6-pin, 2-1/4" door	

TAILPIECE PACKS – USED WITH ELECTRIFIED FUNCTIONS		
PART NUMBER	DESCRIPTION	LIST PRICE
886F140	Corbin Russwin & ASSA ABLOY ACCENTRA™ fixed core cylinder tailpiece pack, 6-pin, 1-3/8" - 2" door	\$37.00
886F150	Corbin Russwin & ASSA ABLOY ACCENTRA™ fixed core cylinder tailpiece pack, 6-pin, 2-1/4" door	
886F160	Corbin Russwin & ASSA ABLOY ACCENTRA™ fixed core cylinder tailpiece pack, 7-pin, 1-3/8" - 2" door	
886F170	Corbin Russwin & ASSA ABLOY ACCENTRA™ fixed core cylinder tailpiece pack, 7-pin, 2-1/4" door	
886F180	Schlage® & SARGENT keyway fixed core cylinder tailpiece pack, 1-3/8" - 2" door	
886F190	Schlage® & SARGENT keyway fixed core cylinder tailpiece pack, 2-1/4" door	
886F200	Corbin Russwin LFIC tailpiece pack, 6- or 7-pin, 1-3/8" - 2" door	\$11.00
886F210	Corbin Russwin LFIC tailpiece pack, 6- or 7-pin, 2-1/4" door	
886F220	SFIC tailpiece pack, 6-or7-pin, 1-3/8" - 2" door	\$11.00
886F230	SFIC tailpiece pack, 6-or7-pin, 2-1/4" door	
886F120	SARGENT fixed core tailpiece pack, 6-pin, 1-3/8" - 2" door	\$28.00
886F130	SARGENT fixed core tailpiece pack, 6-pin, 2-1/4" door	
886F260	Schlage® LFIC tailpiece pack, 6-pin, 1-3/8" - 2" door	\$37.00
886F270	Schlage® LFIC tailpiece pack, 6-pin, 2-1/4" door	
886F240	ASSA ABLOY ACCENTRA™ LFIC tailpiece pack, 6-pin, 1-3/8" - 2" door	
886F250	ASSA ABLOY ACCENTRA™ LFIC tailpiece pack, 6-pin, 2-1/4" door	

OUTSIDE SPRING HOUSING ASSEMBLIES (1-3/8" - 2-1/4" DOOR)		
PART NO.	DESCRIPTION	LIST PRICE
860F608	All Functions except CLX3380, CLX3381, CLX3383, CLX3350, CLX3370	\$295.00
860F638	All Functions for ASSA ABLOY ACCENTRA™ LFIC	
DUMMY SPRING HOUSING ASSEMBLIES		
863F108	Outside CLX3350, CLX3370	\$295.00
863F118	Inside CLX3370	
MISCELLANEOUS CYLINDER PARTS		
862F049	Spacer only - fixed core cylinder	\$4.50
627F009	Disposable cores, Corbin Russwin LFIC (10 pack)	\$76.00
707F299	Disposable cores, SFIC (10 pack)	\$67.00

INSIDE SPRING HOUSING ASSEMBLIES (1-3/8" - 2" DOOR)		
PART NO.	DESCRIPTION	LIST PRICE
860F618	All Functions except CLX3332, CLX3352, CLX3362, CLX3372, CLX3381, CLX3382, CLX3383, CLX3390, CLX3350, CLX3370	\$295.00
860F628	Functions CLX3332, CLX3352, CLX3362, CLX3372, CLX3381, CLX3382, CLX3383	
860F648	All Functions for ASSA ABLOY ACCENTRA™ LFIC CLX3332, CLX3352, CLX3362, CLX3372, CLX3381, CLX3382, CLX3383	
885F860	All functions with Request to Exit Option (M92)	

LOCKSET PARTS

LEVERS 1-3/8" TO 2-1/4" DOORS

PART NO.	DESCRIPTION	LIST PRICE	PART NO.	DESCRIPTION	LIST PRICE
860F005	AZ - Passage/plain	\$175.00	860F465	PZ - LFIC (Corbin Russwin 6-pin)	\$175.00
860F055	AZ - Emergency key hole		860F475	PZ - LFIC (Corbin Russwin 6-pin inside CLX3352)	
860F015	AZ - Fixed core cylinder (Corbin Russwin 6/7-pin, ASSA ABLOY ACCENTRA™ 6/7-pin, Schlage® 6-pin)		860F485	PZ - LFIC (Corbin Russwin 7-pin)	
860F025	AZ - Fixed core cylinder (Corbin Russwin 6/7-pin, ASSA ABLOY ACCENTRA™ 6/7-pin, Schlage® 6-pin inside CLX3352)		860F495	PZ - LFIC (Corbin Russwin 7-pin inside CLX3352)	
860F035	AZ - Push/turn button or fixed core cylinder (SARGENT® 6-pin)		860F525	PZ - LFIC (Schlage® 6-pin)	
860F045	AZ - Fixed core cylinder (SARGENT® inside CLX3352)		860F535	PZ - LFIC (Schlage® 6-pin inside CLX3352)	
860F065	AZ - LFIC (Corbin Russwin 6-pin)		860F545	PZ - LFIC (ASSA ABLOY ACCENTRA™ 6-pin)	
860F075	AZ - LFIC (Corbin Russwin 6-pin inside CLX3352)		860F555	PZ - LFIC (ASSA ABLOY ACCENTRA™ 6-pin inside CLX3352)	
860F085	AZ - LFIC (Corbin Russwin 7-pin)		860F505	PZ - SFIC 6/7-pin	
860F095	AZ - LFIC (Corbin Russwin 7-pin inside CLX3352)		860F515	PZ - SFIC 6/7-pin (inside CLX3352)	
860F125	AZ - LFIC (Schlage® 6-pin)		860F655	102 - Passage/plain	
860F135	AZ - LFIC (Schlage® 6-pin inside CLX3352)		860F705	102 - Emergency key hole	
860F145	AZ - LFIC (ASSA ABLOY ACCENTRA™ 6-pin)		860F665	102 - Fixed core cylinder (Corbin Russwin 6/7-pin, ASSA ABLOY ACCENTRA™ 6/7-pin, Schlage® 6-pin)	
860F155	AZ - LFIC (ASSA ABLOY ACCENTRA™ 6-pin inside CLX3352)		860F685	102 - Push/turn button or fixed core cylinder (SARGENT® 6-pin)	
860F105	AZ - SFIC 6/7-pin		860F715	102 - LFIC (Corbin Russwin 6-pin)	
860F115	AZ - SFIC 6/7-pin (inside CLX3352)		860F735	102 - LFIC (Corbin Russwin 7-pin)	
860F205	NZ - Passage/plain		860F755	102 - SFIC 6/7-pin	
860F255	NZ - Emergency key hole		860F905	106 - Passage/plain	
860F215	NZ - Fixed core cylinder (Corbin Russwin 6/7-pin, ASSA ABLOY ACCENTRA™ 6/7-pin, Schlage® 6-pin)		860F955	106 - Emergency key hole	
860F225	NZ - Fixed core cylinder (Corbin Russwin 6/7-pin, ASSA ABLOY ACCENTRA™ 6/7-pin, Schlage® 6-pin inside CLX3352)		860F915	106 - Fixed core cylinder (Corbin Russwin 6/7-pin, ASSA ABLOY ACCENTRA™ 6/7-pin, Schlage® 6-pin)	
860F235	NZ - Push/turn button or fixed core cylinder (SARGENT® 6-pin)		860F935	106 - Push/turn button or fixed core cylinder (SARGENT® 6-pin)	
860F245	NZ - Fixed core cylinder (SARGENT® inside CLX3352)		860F965	106 - LFIC (Corbin Russwin 6-pin)	
860F265	NZ - LFIC (Corbin Russwin 6-pin)		860F985	106 - LFIC (Corbin Russwin 7-pin)	
860F275	NZ - LFIC (Corbin Russwin 6-pin inside CLX3352)		861F015	106 - SFIC 6/7-pin	
860F285	NZ - LFIC (Corbin Russwin 7-pin)		861F035	123 - Passage/plain	
860F295	NZ - LFIC (Corbin Russwin 7-pin inside CLX3352)		861F085	123 - Emergency key hole	
860F325	NZ - LFIC (Schlage® 6-pin)		861F045	123 - Fixed core cylinder (Corbin Russwin 6/7-pin, ASSA ABLOY ACCENTRA™ 6/7-pin, Schlage® 6-pin)	
860F335	NZ - LFIC (Schlage® 6-pin inside CLX3352)		861F065	123 - Push/turn button or fixed core cylinder (SARGENT® 6-pin)	
860F345	NZ - LFIC (ASSA ABLOY ACCENTRA™ 6-pin)		861F095	123 - LFIC (Corbin Russwin 6-pin)	
860F355	NZ - LFIC (ASSA ABLOY ACCENTRA™ 6-pin inside CLX3352)		861F115	123 - LFIC (Corbin Russwin 7-pin)	
860F305	NZ - SFIC 6/7-pin		861F135	123 - SFIC 6/7-pin	
860F315	NZ - SFIC 6/7-pin (inside CLX3352)		860F775	124 - Passage/plain	
860F405	PZ - Passage/plain		860F825	124 - Emergency key hole	
860F455	PZ - Emergency key hole		860F785	124 - Fixed core cylinder (Corbin Russwin 6/7-pin, ASSA ABLOY ACCENTRA™ 6/7-pin, Schlage® 6-pin)	
860F415	PZ - Fixed core cylinder (Corbin Russwin 6/7-pin, ASSA ABLOY ACCENTRA™ 6/7-pin, Schlage® 6-pin)		860F805	124 - Push/turn button or fixed core cylinder (SARGENT® 6-pin)	
860F425	PZ - Fixed core cylinder (Corbin Russwin 6/7-pin, ASSA ABLOY ACCENTRA™ 6/7-pin, Schlage® 6-pin inside CLX3352)		860F835	124 - LFIC (Corbin Russwin 6-pin)	
860F435	PZ - Push/turn button or fixed core cylinder (SARGENT® 6-pin)		860F855	124 - LFIC (Corbin Russwin 7-pin)	
860F445	PZ - Fixed core cylinder (SARGENT® inside CLX3352)		860F875	124 - SFIC 6/7-pin	

LOCKSET PARTS

PART NO.	DESCRIPTION	LIST PRICE	PART NO.	DESCRIPTION	LIST PRICE
LEVERS 1-3/8" TO 2-1/4" DOORS WITH KNURLING			LEVERS 1-3/8" TO 2-1/4" DOORS WITH ABRASIVE COAT		
860N005	AZ - Passage/plain	\$175.00	860R005	AZ - Passage/plain	\$175.00
860N055	AZ - Emergency key hole		860R055	AZ - Emergency key hole	
860N015	AZ - Fixed core cylinder (Corbin Russwin 6/7-pin, ASSA ABLOY ACCENTRA™ 6/7-pin, Schlage® 6-pin)		860R015	AZ - Fixed core cylinder (Corbin Russwin 6/7-pin, ASSA ABLOY ACCENTRA™ 6/7-pin, Schlage® 6-pin)	
860N025	AZ - Fixed core cylinder (Corbin Russwin 6/7-pin, ASSA ABLOY ACCENTRA™ 6/7-pin, Schlage® 6-pin inside CLX3352)		860R025	AZ - Fixed core cylinder (Corbin Russwin 6/7-pin, ASSA ABLOY ACCENTRA™ 6/7-pin, Schlage® 6-pin inside CLX3352)	
860N035	AZ - Push/turn button or fixed core cylinder (SARGENT® 6-pin)		860R035	AZ - Push/turn button or fixed core cylinder (SARGENT® 6-pin)	
860N045	AZ - Fixed core cylinder (SARGENT® inside CLX3352)		860R045	AZ - Fixed core cylinder (SARGENT® inside CLX3352)	
860N065	AZ - LFIC (Corbin Russwin 6-pin)		860R065	AZ - LFIC (Corbin Russwin 6-pin)	
860N075	AZ - LFIC (Corbin Russwin 6-pin inside CLX3352)		860R075	AZ - LFIC (Corbin Russwin 6-pin inside CLX3352)	
860N085	AZ - LFIC (Corbin Russwin 7-pin)		860R085	AZ - LFIC (Corbin Russwin 7-pin)	
860N095	AZ - LFIC (Corbin Russwin 7-pin inside CLX3352)		860R095	AZ - LFIC (Corbin Russwin 7-pin inside CLX3352)	
860N125	AZ - LFIC (Schlage® 6-pin)		860R125	AZ - LFIC (Schlage® 6-pin)	
860N135	AZ - LFIC (Schlage® 6-pin inside CLX3352)		860R135	AZ - LFIC (Schlage® 6-pin inside CLX3352)	
860N145	AZ - LFIC (ASSA ABLOY ACCENTRA™ 6-pin)		860R145	AZ - LFIC (ASSA ABLOY ACCENTRA™ 6-pin)	
860N155	AZ - LFIC (ASSA ABLOY ACCENTRA™ 6-pin inside CLX3352)		860R155	AZ - LFIC (ASSA ABLOY ACCENTRA™ 6-pin inside CLX3352)	
860N105	AZ - SFIC 6/7-pin		860R105	AZ - SFIC 6/7-pin	
860N115	AZ - SFIC 6/7-pin (inside CLX3352)		860R115	AZ - SFIC 6/7-pin (inside CLX3352)	
860N205	NZ - Passage/plain		860R205	NZ - Passage/plain	
860N255	NZ - Emergency key hole		860R255	NZ - Emergency key hole	
860N215	NZ - Fixed core cylinder (Corbin Russwin 6/7-pin, ASSA ABLOY ACCENTRA™ 6/7-pin, Schlage® 6-pin)		860R215	NZ - Fixed core cylinder (Corbin Russwin 6/7-pin, ASSA ABLOY ACCENTRA™ 6/7-pin, Schlage® 6-pin)	
860N225	NZ - Fixed core cylinder (Corbin Russwin 6/7-pin, ASSA ABLOY ACCENTRA™ 6/7-pin, Schlage® 6-pin inside CLX3352)		860R225	NZ - Fixed core cylinder (Corbin Russwin 6/7-pin, ASSA ABLOY ACCENTRA™ 6/7-pin, Schlage® 6-pin inside CLX3352)	
860N235	NZ - Push/turn button or fixed core cylinder (SARGENT® 6-pin)		860R235	NZ - Push/turn button or fixed core cylinder (SARGENT® 6-pin)	
860N245	NZ - Fixed core cylinder (SARGENT® inside CLX3352)		860R245	NZ - Fixed core cylinder (SARGENT® inside CLX3352)	
860N265	NZ - LFIC (Corbin Russwin 6-pin)		860R265	NZ - LFIC (Corbin Russwin 6-pin)	
860N275	NZ - LFIC (Corbin Russwin 6-pin inside CLX3352)		860R275	NZ - LFIC (Corbin Russwin 6-pin inside CLX3352)	
860N285	NZ - LFIC (Corbin Russwin 7-pin)		860R285	NZ - LFIC (Corbin Russwin 7-pin)	
860N295	NZ - LFIC (Corbin Russwin 7-pin inside CLX3352)		860R295	NZ - LFIC (Corbin Russwin 7-pin inside CLX3352)	
860N325	NZ - LFIC (Schlage® 6-pin)		860R325	NZ - LFIC (Schlage® 6-pin)	
860N335	NZ - LFIC (Schlage® 6-pin inside CLX3352)		860R335	NZ - LFIC (Schlage® 6-pin inside CLX3352)	
860N345	NZ - LFIC (ASSA ABLOY ACCENTRA™ 6-pin)		860R345	NZ - LFIC (ASSA ABLOY ACCENTRA™ 6-pin)	
860N355	NZ - LFIC (ASSA ABLOY ACCENTRA™ 6-pin inside CLX3352)		860R355	NZ - LFIC (ASSA ABLOY ACCENTRA™ 6-pin inside CLX3352)	
860N305	NZ - SFIC 6/7-pin		860R305	NZ - SFIC 6/7-pin	
860N315	NZ - SFIC 6/7-pin (inside CLX3352)		860R315	NZ - SFIC 6/7-pin (inside CLX3352)	
860N405	PZ - Passage/plain		860R405	PZ - Passage/plain	
860N455	PZ - Emergency key hole		860R415	PZ - Emergency key hole	
860N415	PZ - Fixed core cylinder (Corbin Russwin 6/7-pin, ASSA ABLOY ACCENTRA™ 6/7-pin, Schlage® 6-pin)		860R425	PZ - Fixed core cylinder (Corbin Russwin 6/7-pin, ASSA ABLOY ACCENTRA™ 6/7-pin, Schlage® 6-pin)	
860N425	PZ - Fixed core cylinder (Corbin Russwin 6/7-pin, ASSA ABLOY ACCENTRA™ 6/7-pin, Schlage® 6-pin inside CLX3352)		860R435	PZ - Fixed core cylinder (Corbin Russwin 6/7-pin, ASSA ABLOY ACCENTRA™ 6/7-pin, Schlage® 6-pin inside CLX3352)	
860N435	PZ - Push/turn button or fixed core cylinder (SARGENT® 6-pin)		860R445	PZ - Push/turn button or fixed core cylinder (SARGENT® 6-pin)	
860N445	PZ - Fixed core cylinder (SARGENT® inside CLX3352)		860R455	PZ - Fixed core cylinder (SARGENT® inside CLX3352)	
860N465	PZ - LFIC (Corbin Russwin 6-pin)		860R465	PZ - LFIC (Corbin Russwin 6-pin)	
860N475	PZ - LFIC (Corbin Russwin 6-pin inside CLX3352)		860R475	PZ - LFIC (Corbin Russwin 6-pin inside CLX3352)	
860N485	PZ - LFIC (Corbin Russwin 7-pin)	860R485	PZ - LFIC (Corbin Russwin 7-pin)		
860N495	PZ - LFIC (Corbin Russwin 7-pin inside CLX3352)	860R495	PZ - LFIC (Corbin Russwin 7-pin inside CLX3352)		
860N525	PZ - LFIC (Schlage® 6-pin)	860R525	PZ - LFIC (Schlage® 6-pin)		
860N535	PZ - LFIC (Schlage® 6-pin inside CLX3352)	860R535	PZ - LFIC (Schlage® 6-pin inside CLX3352)		
860N545	PZ - LFIC (ASSA ABLOY ACCENTRA™ 6-pin)	860R545	PZ - LFIC (ASSA ABLOY ACCENTRA™ 6-pin)		
860N555	PZ - LFIC (ASSA ABLOY ACCENTRA™ 6-pin inside CLX3352)	860R555	PZ - LFIC (ASSA ABLOY ACCENTRA™ 6-pin inside CLX3352)		
860N505	PZ - SFIC 6/7-pin	860R505	PZ - SFIC 6/7-pin		
860N515	PZ - SFIC 6/7-pin (inside CLX3352)	860R515	PZ - SFIC 6/7-pin (inside CLX3352)		

LOCKSET PARTS

PART NO.	DESCRIPTION	LIST PRICE
MISCELLANEOUS		
865F298	Emergency Release Tool (CLX3320)	\$4.50
867F388	1-3/8" Door Adapter Plates Pack (D138)	\$69.00
865F199	Hotel Adjustment Tool	\$16.40
041F478	Hotel Shut-out Key	\$4.50
889F829	Cylindrical Lock Door Prep Tool	\$25.00
LATCH ASSEMBLY		
2 3/4" Backsets		
867F20	Plain, square corner	\$115.00
867F26	Plain, rounded corner	
867F21	Deadlocking square corner mechanical functions	\$132.00
867F27	Deadlocking rounded corner mechanical functions	
867F32	Deadlocking square corner electrified functions	
867F35	Deadlocking rounded corner electrified functions	
601F69	3/4" Throw deadlocking fire latch square corner	\$168.00
2 3/8" Backsets		
599F91	Plain, square corner 1" front	\$101.00
599F97	Plain, square corner 1-1/8" front	
599F94	Plain, rounded corner 1" front	
600F00	Plain, rounded corner 1-1/8" front	
599F92	Deadlocking, square corner 1" front	
599F98	Deadlocking, square corner 1-1/8" front	
599F95	Deadlocking, rounded corner 1" front	
600F01	Deadlocking, rounded corner 1-1/8" front	
3 3/4" Backsets		
867F22	Plain, square corner	\$222.00
867F28	Plain, round corner	
867F23	Deadlocking square corner mechanical functions	\$234.00
867F29	Deadlocking rounded corner mechanical functions	
867F33	Deadlocking square corner electrified functions	
867F36	Deadlocking rounded corner electrified functions	
5" Backsets		
867F24	Plain, square corner	\$160.00
867F30	Plain, rounded corner	
867F25	Deadlocking square corner mechanical functions	\$168.00
867F31	Deadlocking rounded corner mechanical functions	
867F34	Deadlocking square corner electrified functions	
867F37	Deadlocking rounded corner electrified functions	

PART NO.	DESCRIPTION	LIST PRICE	
LATCH & STRIKE SCREW PACKS			
604F228 Fin	Latch & ANSI (4 7/8") strike – phillips head	\$11.00	
604F238 Fin	Latch & ANSI (4 7/8") strike – spanner head	\$23.00	
604F248 Fin	Latch & ANSI (4 7/8") strike – Torx head	\$23.00	
604F268 Fin	Latch & T (2 3/4") strike – phillips head	\$11.00	
604F278 Fin	Latch & T (2 3/4") strike – spanner head	\$23.00	
604F288 Fin	Latch & T (2 3/4") strike – Torx head	\$23.00	
MOUNTING SCREW PACKS			
865F308	1 3/8" – 2" doors	\$11.00	
865F398	Over 2"	\$16.00	
867F73 Fin	CLX3390 1 3/8" – 2 1/4" phillips head	\$11.00	
867F74 Fin	CLX3390 1 3/8" – 2 1/4" spanner head	\$23.00	
867F75 Fin	CLX3390 1 3/8" – 2 1/4" Torx head	\$23.00	
867F70 Fin	CLX3350 Half Dummy Trim - phillips head	\$16.00	
867F71 Fin	CLX3350 Half Dummy Trim - spanner head	\$72.00	
867F72 Fin	CLX3350 Half Dummy Trim - Torx head	\$72.00	
ROSES/ROSE LINERS			
678F25 Fin	Rose	\$73.00	
598F59 Fin	Blank Rose/Plate CLX3380, CLX3381, CLX3383	\$46.00	
789F018	Rose liner I/S 1 3/4" – 2"	\$11.00	
789F028	Rose liner I/S over 2"	\$11.00	
789F058	Rose liner O/S 1 3/4" – 2"		
789F068	Rose liner O/S over 2"	\$11.00	
865F32 x Fin	Thumbturn ass'y 1 3/4" – 2" (CLX3390)	\$139.00	
865F33 x Fin	Thumbturn ass'y over 2" (CLX3390)		
789F228	Rose liner ass'y O/S CLX3380, CLX3381, CLX3383	\$44.00	
STRIKES – 4 7/8" ANSI CURVED LIP			
217L13M016	1" Lip Length	\$37.00	
217L13M018	1 1/8" Lip Length		
217L13M020	1 1/4" Lip Length		
217L13M022	1 3/8" Lip Length		
217L13M024	1 1/2" Lip Length		
217L13M028	1 3/4" Lip Length		
217L13M032	2" Lip Length		
217L13M036	2 1/4" Lip Length		
217L13M040	2 1/2" Lip Length		
217L13M044	2 3/4" Lip Length		
217L13M048	3" Lip Length		
120F768	4 7/8" strike box		\$7.40
STRIKES – 2 3/4" T- CURVED LIP			
586L19M016	1" Lip Length		\$37.00
586L19M018	1 1/8" Lip Length		
586L19M020	1 1/4" Lip Length		
586L19M022	1 3/8" Lip Length		
586L19M024	1 1/2" Lip Length		
586L19M028	1 3/4" Lip Length		
586L19M032	2" Lip Length		
586L19M036	2 1/4" Lip Length		
586L19M040	2 1/2" Lip Length		
586L19M044	2 3/4" Lip Length		
586L19M048	3" Lip Length		
STRIKE - 2 3/4" FULL LIP			
607F76	1-1/8" Lip Length	\$15.00	

LOCKSET PARTS

PART NO.	DESCRIPTION	LIST PRICE
CHASSIS ASSEMBLY STANDARD		
785F008	CL3310	\$263.00
785F118 Fin	CL3320, CL3361	\$277.00
785F138 Fin	CL3320TO	\$263.00
785F078 Fin	CL3329	\$324.00
785F068	CL3332	\$314.00
785F028 Fin	CL3340	\$305.00
785F038	CL3340NT	\$279.00
785F018 Fin	CL3351, CL3357	
785F048	CL3352, CL3355	\$324.00
785F148	CL3359	\$279.00
785F058	CL3362	\$314.00
785F088	CL3372	
785F158 Fin	CL3375	\$297.00
785F098	CL3380, CL3390	\$297.00
785F108	CL3381, CL3391	\$297.00
785F378 Fin	CL3393	\$297.00
785F188	CL33903-12AD	\$720.00
785F168	CL33903-24AD	
785F198	CL33905-12AD	
785F178	CL33905-24AD	
CHASSIS ASSEMBLY, LFIC		
785F298	CL3361	\$314.00
785F268 Fin	CL3329	\$343.00
785F258	CL3332	\$334.00
785F218 Fin	CL3351, CL3357, CL3393	\$305.00
785F238	CL3352	\$334.00
785F228	CL3355	
785F308	CL3359	\$305.00
785F248	CL3362	\$334.00
785F278	CL3372	
785F318 Fin	CL3375	\$283.00
785F288	CL3381, CL3391	\$318.00
785F388 Fin	CL3393	\$283.00
785F348	CL33903-12AD	\$720.00
785F328	CL33903-24AD	
785F358	CL33905-12AD	
785F338	CL33905-24AD	

PART NO.	DESCRIPTION	LIST PRICE
CYLINDER PARTS		
622F308	Tailpiece 6-pin	\$4.50
682F298	Tailpiece 7-pin	
631F248	Corbin Russwin LFIC core kit	\$11.00
682F958	SFIC tailpiece kit	
682F969	Sargent® tailpiece kit	\$28.00
697F942	Schlage® LFIC tailpiece kit	\$37.00
682F398	Schlage® tailpiece kit	\$28.00
HOUSING ASSEMBLIES		
783F208	Spring housing O/S	\$55.00
783F308	Spring housing I/S 1 3/4"-2"	\$46.00
783F408	Spring housing I/S 2 1/4"	
686F858	Dummy housing I/S	\$168.00
686F868	Dummy housing O/S	\$154.00
EMERGENCY RELEASE TOOL		
679F818	Emergency Release Tool (CL3320)	\$4.50
LEVER INSERT		
585F729	Lever insert (black)	\$4.50
LATCH ASSEMBLY		
2 3/4" Backsets		
586F16	Plain, square corner	\$115.00
596F66	Plain, rounded corner	
586F17	Deadlocking square corner	\$132.00
596F67	Deadlocking rounded corner	
586F18	Throw-Off square corner	
596F68	Throw-Off rounded corner	
601F69	3/4" Throw deadlocking fire latch square corner	\$168.00
3 3/4" Backsets		
586F80	Plain, square corner	\$222.00
586F86	Plain, rounded corner	
586F81	Deadlocking square corner	\$234.00
586F87	Deadlocking rounded corner	
586F82	Throw-Off square corner	
586F88	Throw-Off rounded corner	
5" Backsets		
598F20	Plain, square corner	\$160.00
601F24	Plain, rounded corner	
598F21	Deadlocking square corner	\$168.00
601F25	Deadlocking rounded corner	
598F22	Throw-Off square corner	
601F26	Throw-Off rounded corner	

LOCKSET PARTS

PART NO.	DESCRIPTION	LIST PRICE	PART NO.	DESCRIPTION	LIST PRICE
LEVERS 1-3/4" TO 2" DOORS			LEVERS 1-3/4" TO 2" DOORS (Cont'd)		
563F945	NZD - Plain	\$168.00	799F805	PZD - SFIC	\$168.00
563F955	NZD - Cylinder button		799F815	PZD - SFIC CL3352 inside	
714F065	NZD - CL3352 inside		799F825	PZD - Schlage® LFIC	
563F965	NZD - Emergency key hole		799F835	PZD - Schlage® LFIC CL3352 inside	
585F715	NZD - LFIC cylinder - 6 pin		799F545	PZD - Sargent Fixed Core Cylinder	
714F365	NZD - LFIC cylinder - 6 pin CL3352 inside		799F555	PZD - Sargent Fixed Core Cylinder CL3352 Inside	
600F415	NZD - LFIC cylinder - 7 pin		712F205	FZD - LH plain	
714F375	NZD - LFIC cylinder - 7 pin CL3352 inside		712F215	FZD - LH cylinder or button	
596F825	NZD - SFIC		712F385	FZD - LH CL3352 inside	
714F425	NZD - SFIC CL3352 inside		712F225	FZD - LH emergency key hole	
690F975	NZD - Schlage® LFIC		715F245	FZD - LH Corbin Russwin LFIC - 6 pin	
714F455	NZD - Schlage® LFIC CL3352 inside		712F405	FZD - LH Corbin Russwin LFIC - 6 pin CL3352 inside	
578F435	NZD - Sargent Fixed Core Cylinder		714F255	FZD - LH Corbin Russwin LFIC - 7 pin	
714F125	NZD - Sargent Fixed Core Cylinder CL3352 Inside		712F415	FZD - LH Corbin Russwin LFIC - 7 pin CL3352 inside	
563F885	AZD - Plain		712F265	FZD - LH SFIC	
563F895	AZD - Cylinder or button		712F425	FZD - LH SFIC CL3352 inside	
714F005	AZD - CL3352 inside		712F275	FZD - LH Schlage® LFIC	
563F905	AZD - Emergency key hole		712F435	FZD - LH Schlage® LFIC CL3352 inside	
585F705	AZD - Corbin Russwin LFIC - 6 pin		712F235	FZD - LH Sargent Fixed Core Cylinder	
714F305	AZD - Corbin Russwin LFIC - 6 pin CL3352 inside		712F395	FZD - LH Sargent Fixed Core Cylinder CL3352 Inside	
600F425	AZD - Corbin Russwin LFIC - 7 pin inside		712F505	FZD - RH plain	
714F315	AZD - Corbin Russwin LFIC - 7 pin CL3352 inside		712F515	FZD - RH cylinder or button	
409F865	AZD - SFIC		712F685	FZD - RH CL3352 inside	
540F625	AZD - SFIC CL3352 inside		712F525	FZD - RH emergency key hole	
695F075	AZD - Sargent Fixed Core Cylinder		712F545	FZD - RH Corbin Russwin LFIC - 6 pin	
714F035	AZD - Sargent Fixed Core Cylinder CL3352 Inside		712F705	FZD - RH Corbin Russwin LFIC - 6 pin CL3352 inside	
799F505	PZD - Plain		712F555	FZD - RH Corbin Russwin LFIC - 7 pin CL3352 inside	
799F515	PZD - Cylinder or button		712F715	FZD - RH Corbin Russwin LFIC - 7 pin CL3352 inside	
799F535	PZD - CL3352 inside		712F565	FZD - RH SFIC	
799F525	PZD - Emergency key hole		712F725	FZD - RH SFIC CL3352 inside	
799F565	PZD - Corbin Russwin LFIC - 6 pin		712F575	FZD - Schlage® LFIC	
799F575	PZD - Corbin Russwin LFIC - 6 pin CL3352 inside		712F735	FZD - Schlage® LFIC CL3352 inside	
799F585	PZD - Corbin Russwin LFIC - 7 pin	712F535	FZD - RH Sargent Fixed Core Cylinder		
799F595	PZD - Corbin Russwin LFIC - 7 pin CL3352 inside	712F695	FZD - RH Sargent Fixed Core Cylinder CL3352 Inside		

LOCKSET PARTS

PART NO.	DESCRIPTION	LIST PRICE	PART NO.	DESCRIPTION	LIST PRICE
LEVERS 2 1/4" DOORS			LEVERS 2 1/4" DOORS (Cont'd)		
684F825	NZD - Plain	\$168.00	799F845	PZD - SFIC	\$168.00
684F835	NZD - Cylinder or button		799F855	PZD - SFIC CL3352 inside	
714F215	NZD - CL3352 inside		799F865	PZD - Schlage® LFIC	
684F845	NZD - Emergency key hole		799F875	PZD - Schlage LFIC CL3352 inside	
684F865	NZD - Corbin Russwin LFIC - 6 pin		799F645	PZD - Sargent Fixed Core Cylinder	
714F545	NZD - Corbin Russwin LFIC - 6 pin CL3352 inside		799F655	PZD - Sargent Fixed Core Cylinder CL3352 Inside	
685F875	NZD - Corbin Russwin LFIC - 7 pin		712F305	FZD - LH plain	
714F555	NZD - Corbin Russwin LFIC - 7 pin CL3352 inside		712F315	FZD - LH cylinder or botton	
684F885	NZD - SFIC		712F445	FZD - LH CL3352 inside	
714F605	NZD - SFIC CL3352 inside		712F325	FZD - LH emergency key hole	
690F985	NZD - Schlage® LFIC		712F345	FZD - Corbin Russwin LFIC - 6 pin	
714F635	NZD - Schlage® LFIC CL3352 inside		712F465	FZD - Corbin Russwin LFIC - 6 pin CL3352 inside	
684F855	NZD - Sargent Fixed Core Cylinder		712F355	FZD - Corbin Russwin LFIC - 7 pin	
714F275	NZD - Sargent Fixed Core Cylinder CL3352 Inside		712F475	FZD - Corbin Russwin LFIC - 7 pin CL3352 inside	
684F775	AZD - Plain		712F365	FZD - LH SFIC	
684F785	AZD - Cylinder or button		712F485	FZD - LH SFIC CL3352 inside	
714F155	AZD - CL3352 inside		712F375	FZD - LH Schlage® LFIC	
684F795	AZD - Emergency key hole		712F495	FZD - LH Schlage® LFIC CL3352 inside	
684F805	AZD - Corbin Russwin LFIC - 6 pin		712F335	FZD - LH Sargent Fixed Core Cylinder	
714F485	AZD - Corbin Russwin LFIC - 6 pin CL3352 inside		712F455	FZD - LH Sargent Fixed Core Cylinder CL3352 Inside	
684F815	AZD - Corbin Russwin LFIC - 7 pin		712F605	FZD - RH plain	
714F495	AZD - Corbin Russwin LFIC - 7 pin CL3352 inside		712F615	FZD - RH cylinder or button	
409F875	AZD - SFIC		712F745	FZD - RH CL3352 inside	
540F685	AZD - SFIC CL3352 inside		712F625	FZD - RH emergency key hole	
697F995	AZD - Sargent Fixed Core Cylinder		712F645	FZD - RH Corbin Russwin LFIC - 6 pin	
714F185	AZD - Sargent Fixed Core Cylinder CL3352 Inside		712F765	FZD - RH Corbin Russwin LFIC - 6 pin CL3352 inside	
799F605	PZD - Plain		712F655	FZD - RH Corbin Russwin LFIC - 7 pin	
799F615	PZD - Cylinder or button		712F775	FZD - RH Corbin Russwin LFIC - 7 pin CL3352 inside	
799F635	PZD - CL3352 inside		712F665	FZD - RH SFIC	
799F625	PZD - Emergency key hole		712F785	FZD - RH SFIC CL3352 inside	
799F665	PZD - Corbin Russwin LFIC - 6 pin		712F675	FZD - RH Schlage® LFIC	
799F675	PZD - Corbin Russwin LFIC - 6 pin CL3352 inside		712F795	FZD - RH Schlage® LFIC CL3352 inside	
799F685	PZD - Corbin Russwin LFIC - 7 pin	712F635	FZD - RH Sargent Fixed Core Cylinder		
799F695	PZD - Corbin Russwin LFIC - 7 pin CL3352 inside	712F755	FZD - RH Sargent Fixed Core Cylinder CL3352 Inside		

LOCKSET PARTS

PART NO.	DESCRIPTION	LIST PRICE
LATCH & STRIKE SCREW PACKS		
604F228 Fin	Latch & ANSI (4 7/8") strike - phillips head	\$11.00
604F238 Fin	Latch & ANSI (4 7/8") strike - spanner head	\$23.00
604F248 Fin	Latch & ANSI (4 7/8") strike - Torx head	
604F268 Fin	Latch & T (2 3/4") strike - phillips head	\$11.00
604F278 Fin	Latch & T (2 3/4") strike - spanner head	\$23.00
604F288 Fin	Latch & T (2 3/4") strike - Torx head	
480F688 Fin	Rabbetted Strike - phillips head	\$11.00
596F618 Fin	Rabbetted Strike - spanner head	\$23.00
596F628 Fin	Rabbetted Strike - Torx head	
MOUNTING SCREW PACKS		
682F608	1 3/4" - 2" doors (pre June 2004)	\$11.00
710F658	1 3/4" - 2" doors (after June 2004)	
682F618	Over 2" (pre June 2004)	\$16.00
710F668	Over 2" (after June 2004)	
682F628	CL3380, CL3381 1 3/4" - 2" doors	\$11.00
682F638	CL3380, CL3381 over 2" doors	\$16.00
682F64 Fin	CL3390, CL3391 1 3/4" - 2" phillips head	\$11.00
682F67 Fin	CL3390, CL3391 1 3/4" - 2" spanner head	\$23.00
682F68 Fin	CL3390, CL3391 1 3/4" - 2" Torx head	
682F65 Fin	CL3390, CL3391 over 2" phillips head	\$72.00
682F86 Fin	CL3390, CL3391 over 2" spanner head	
682F87 Fin	CL3390, CL3391 over 2" Torx head	\$16.00
684F44 Fin	CL3350 Half Dummy Trim - phillips head	
684F45 Fin	CL3350 Half Dummy Trim - spanner head	\$72.00
684F46 Fin	CL3350 Half Dummy Trim - Torx head	
684F528	CL3370 Half Dummy Trim	\$11.00
BUTTONS		
585F76 Fin	Turnbutton CL3351	\$32.00
585F77 Fin	Pushbutton CL3320, CL3320H, CL3320TO, CL3340, CL3361, CL3375	
585F78 Fin	Hotel button CL3329	
585F79 Fin	Slotted button CL3393	

PART NO.	DESCRIPTION	LIST PRICE
FRONT PLATE RABBETTED STRIKE		
315F93 Fin*	606, 612, 619, 626, 605, 611, 613, 625	\$93.00
RABBETTED STRIKE		
315F94 Fin*	606, 612, 619, 626, 605, 611, 613, 625	\$93.00
601F283 Fin*	Rabbetted Strike & Front	\$141.00

ROSES		
678F25 Fin	Rose	\$73.00
598F59 Fin	Blank Rose	\$46.00
710F618	Rose liner I/S 1 3/4" - 2" after June 2004	\$11.00
710F628	Rose liner I/S over 2" after June 2004	
678F248	Rose liner O/S 1 3/4" - 2"	
678F498	Rose liner O/S over 2"	
586F51 Fin	Thumbturn ass'y 1 3/4" - 2"	\$139.00
686F88 Fin	Thumbturn ass'y over 2"	
682F788	Rose liner CL3380, CL3381	\$44.00

STRIKES - 4 7/8" ANSI CURVED LIP		
217L13M016	1" Lip Length	\$37.00
217L13M018	1 1/8" Lip Length	
217L13M020	1 1/4" Lip Length	
217L13M022	1 3/8" Lip Length	
217L13M024	1 1/2" Lip Length	
217L13M028	1 3/4" Lip Length	
217L13M032	2" Lip Length	
217L13M036	2 1/4" Lip Length	
217L13M040	2 1/2" Lip Length	
217L13M044	2 3/4" Lip Length	
217L13M048	3" Lip Length	

STRIKES - 2 3/4" T- CURVED LIP		
586L19M016	1" Lip Length	\$37.00
586L19M018	1 1/8" Lip Length	
586L19M020	1 1/4" Lip Length	
586L19M022	1 3/8" Lip Length	
586L19M024	1 1/2" Lip Length	
586L19M028	1 3/4" Lip Length	
586L19M032	2" Lip Length	
586L19M036	2 1/4" Lip Length	
586L19M040	2 1/2" Lip Length	
586L19M044	2 3/4" Lip Length	
586L19M048	3" Lip Length	

PART NO.	DESCRIPTION	LIST PRICE
BUTTONS		ALL FINISH
585F762	CL3551 (Turn Button)	\$32.00
585F772	CL3520, 61 (Push Button)	
CASSETTE HOUSING O/S		NO FINISH
796F378	Standard	\$47.00
686F858	CL3550, 70	\$168.00
CASSETTE HOUSING I/S		NO FINISH
796F408	CL3580, 81	\$32.00
686F868	CL3570	\$154.00
796F398	Standard I/S Spring Housing	\$26.00
CHASSIS ASSEMBLY, STANDARD		NO FINISH
796F208	CL3510	\$145.00
796F218	CL3520, 61	\$202.00
796F248	CL3580	
796F228	CL3551, 57	
796F238	CL3555	
796F258	CL3581	
796F268	CL3582	\$274.00
CHASSIS ASSEMBLY, LFIC		NO FINISH
796F318	CL3561	\$202.00
796F328	CL3551, 57	
796F338	CL3555	\$216.00
796F358	CL3581	\$241.00
796F368	CL3582	\$283.00
CYLINDER PARTS		NO FINISH
622F308	Tailpiece 6-Pin	\$4.50
682F298	Tailpiece 7-pin	
682F398	M06 - Schlage® tailpiece kit	\$28.00
682F969	M09 - Sargent® tailpiece kit	
631F248	C6/C7 - LFIC tailpiece kit	\$11.00
682F958	M08 - SFIC kit	
697F942	M69 - Schlage® IC tailpiece kit	\$37.00
HOUSING ASSEMBLIES		
796F388	Housing Assembly, I/S, D134	\$23.00
796F398	Housing Assembly, I/S, D138	\$26.00

PART NO.	DESCRIPTION	LIST PRICE
LATCH ASSEMBLY		ALL FINISH
Deadlocking Latches		
599F92	2-3/8" backset x 1" front	\$101.00
599F95	2-3/8" backset x 1" round corner	
599F98	2-3/8" backset x 1-1/8" front	
600F01	2-3/8" backset x 1-1/8" round corner	
600F04	2-3/4" backset x 1" front	
600F07	2-3/4" backset x 1" round corner	
600F10	2-3/4" backset x 1-1/8" front	
600F13	2-3/4" backset x 1-1/8" round corner	
600F63	3-3/4" backset x 1-1/8" front	
600F66	3-3/4" backset x 1-1/8" round corner	
600F69	5" backset x 1-1/8" front	\$139.00
600F72	5" backset x 1-1/8" round corner	
Deadlocking Latches with Release (CL3520)		
599F93	2-3/8" backset x 1" front	\$101.00
599F96	2-3/8" backset x 1" round corner	
599F99	2-3/8" backset x 1-1/8" front	
600F02	2-3/8" backset x 1-1/8" round corner	
600F05	2-3/4" backset x 1" front	
600F08	2-3/4" backset x 1" round corner	
600F11	2-3/4" backset x 1-1/8" front	
600F14	2-3/4" backset x 1-1/8" round corner	
600F64	3 3/4" backset x 1 1/8" front	
600F67	3-3/4" backset x 1-1/8" round corner	
600F70	5" backset x 1 1/8" front	\$139.00
600F73	5" backset x 1-1/8" round corner	
Plain Spring Latches (CL3510)		
599F91	2-3/8" backset x 1" front	\$101.00
599F94	2-3/8" backset x 1" rounded corner	
599F97	2-3/8" backset x 1-1/8" front	
600F00	2-3/8" backset x 1-1/8" rounded corner	
600F03	2-3/4" backset x 1" front	
600F06	2-3/4" backset x 1" rounded corner	
600F09	2-3/4" backset x 1-1/8" front	
600F12	2-3/4" backset x 1-1/8" rounded corner	
600F62	3-3/4" backset x 1-1/8" front	
600F65	3-3/4" backset x 1-1/8" rounded corner	
600F68	5" backset x 1-1/8" front	\$139.00
600F71	5" backset x 1-1/8" rounded corner	

CL3500 Cylindrical Lock Series Heavy-Duty Lever Lockset

USA & Canada Prices Effective March 3, 2025

PART NO.	DESCRIPTION	LIST PRICE
LEVERS		ALL FINISH
598F815	AZD x plain	\$138.00
598F825	AZD x cylinder or button	
598F835	AZD x emergency hole	
598F905	AZD x C6 LFIC 6-pin	
599F275	AZD x C7 LFIC 7-pin	
409F905	AZD x M08 SFIC	
797F845	NZD x plain	
797F855	NZD x cylinder or button	
797F865	NZD x emergency hole	
797F875	NZD x M09 Sargent® cylinder	
797F915	NZD x C6 LFIC 6-pin	
797F925	NZD x C7 LFIC 7-pin	
797F935	NZD x M69 Schlage LFIC	
797F945	NZD x M08 SFIC	
798F115	PZD x plain	
798F125	PZD x cylinder or button	
798F135	PZD x emergency hole	
798F145	PZD x M09 Sargent® cylinder	
798F155	PZD x C6 LFIC 6-pin	
798F165	PZD x C7 LFIC 7-pin	
798F175	PZD x M69 Schlage® LFIC	
798F185	PZD x M08 SFIC	
LEVER INSERT		ALL FINISH
598F809	Standard	\$4.50
MOUNTING SCREW PACK		
796F118	Standard	\$7.40
797F828	Standard - CL3580, 81	\$20.00
684F448	CL3550 (ALL FINISH)	\$16.00
684F528	CL3570	\$11.00

PART NO.	DESCRIPTION	LIST PRICE
ROSES		ALL FINISH
678F252	Standard	\$73.00
598F592	Blank - CL3580, 81	\$46.00
ROSE LINER O/S		NO FINISH
678F248	Standard	\$11.00
682F788	CL3580, 81	\$44.00
SCREW PACKS FOR LATCH & STRIKE		
604F228	For Latch & ANSI Strike	\$11.00
604F268	For Latch & (T strike)	
STRIKES		NO FINISH
ANSI Curved Lip Strike		
217L13M016	1" Lip Length	\$37.00
217L13M018	1-1/8" Lip Length	
217L13M020	1-1/4" Lip Length	
217L13M022	1-3/8" Lip Length	
217L13M024	1-1/2" Lip Length	
217L13M028	1-3/4" Lip Length	
217L13M032	2" Lip Length	
217L13M036	2-1/4" Lip Length	
217L13M040	2-1/2" Lip Length	
217L13M044	2-3/4" Lip Length	
217L13M048	3" Lip Length	
STRIKE BOX		NO FINISH
025F858	Curved lip (T strike)	\$6.00

CL3800 PARTS

PART NO.	DESCRIPTION	LIST PRICE
BUTTONS		ALL FINISH
585F762	CL3851 (Turn Button)	\$32.00
585F772	CL3820, 40, 61 (Push Button)	
CASSETTE HOUSING O/S		NO FINISH
796F378	Standard	\$47.00
686F858	CL3850, 70	\$168.00
CASSETTE HOUSING I/S		NO FINISH
796F398	Standard - 1-3/8" to 1-7/8" door	\$26.00
797F808	D214 - 2" to 2-1/4" door	\$32.00
796F408	CL3880, 81	\$32.00
686F868	CL3870	\$154.00
CHASSIS ASSEMBLY, STANDARD		NO FINISH
797F618	CL3810	\$82.00
797F628	CL3820, 61	\$94.00
797F658	CL3880	\$82.00
797F668	CL3851, 57	\$99.00
797F688	CL3855	
CHASSIS ASSEMBLY, IC		NO FINISH
797F638	CL3861	\$96.00
797F678	CL3851, 57	\$101.00
797F698	CL3855	

PART NO.	DESCRIPTION	LIST PRICE	
CYLINDER PARTS		NO FINISH	
622F308	Tailpiece 6-Pin	\$4.50	
682F298	Tailpiece 7-pin	\$4.50	
682F398	M06 - Schlage® tailpiece kit	\$28.00	
682F969	M09 - SARGENT® tailpiece kit		
631F248	C6/C7 - LFIC tailpiece kit	\$11.00	
682F958	M08 - SFIC kit	\$11.00	
697F942	M69 - Schlage® LFIC tailpiece kit	\$37.00	
LATCH ASSEMBLY		ALL FINISH	
Deadlocking Latches			
599F92	2-3/8" backset x 1" front	\$101.00	
599F95	2-3/8" backset x 1" rounded corner		
599F98	2-3/8" backset x 1-1/8" front		
600F01	2-3/8" backset x 1-1/8" rounded corner		
600F04	2-3/4" backset x 1" front		
600F07	2-3/4" backset x 1" rounded corner		
600F10	2-3/4" backset x 1-1/8" front		
600F13	2-3/4" backset x 1-1/8" rounded corner		
600F63	3-3/4" backset x 1-1/8" front		\$139.00
600F66	3-3/4" backset x 1-1/8" rounded corner		
600F69	5" backset x 1-1/8" front		
600F72	5" backset x 1-1/8" rounded corner		
Deadlocking Latches with Release (CL3810)			
599F93	2-3/8" backset x 1" front	\$101.00	
599F96	2-3/8" backset x 1" rounded corner		
599F99	2-3/8" backset x 1-1/8" front		
600F02	2-3/8" backset x 1-1/8" rounded corner		
600F05	2-3/4" backset x 1" front		
600F08	2-3/4" backset x 1" rounded corner		
600F11	2-3/4" backset x 1-1/8" front		
600F14	2-3/4" backset x 1-1/8" rounded corner		
600F64	3 3/4" backset x 1 1/8" front	\$139.00	
600F67	3-3/4" backset x 1-1/8" rounded corner		
600F70	5" backset x 1 1/8" front		
600F73	5" backset x 1-1/8" rounded corner		
Plain Spring Latches (CL3810)			
599F91	2-3/8" backset x 1" front	\$101.00	
599F94	2-3/8" backset x 1" rounded corner		
599F97	2-3/8" backset x 1-1/8" front		
600F00	2-3/8" backset x 1-1/8" rounded corner		
600F03	2-3/4" backset x 1" front		
600F06	2-3/4" backset x 1" rounded corner		
600F09	2-3/4" backset x 1-1/8" front		
600F12	2-3/4" backset x 1-1/8" rounded corner		
600F62	3-3/4" backset x 1-1/8" front		\$139.00
600F65	3-3/4" backset x 1-1/8" rounded corner		
600F68	5" backset x 1-1/8" front		
600F71	5" backset x 1-1/8" rounded corner		

CL3800 PARTS

PART NO.	DESCRIPTION	LIST PRICE
LEVERS 1-3/8" to 1-7/8" Doors		ALL FINISH
598F815	AZD x plain	\$138.00
598F825	AZD x cylinder or button	
598F835	AZD x emergency hole	
598F905	AZD x C6 LFIC 6-pin	
599F275	AZD x C7 LFIC 7-pin	
409F905	AZD x M08 SFIC	
797F845	NZD x plain	
797F855	NZD x cylinder or button	
797F865	NZD x emergency hole	
797F875	NZD x M09 Sargent® cylinder	
797F915	NZD x C6 LFIC 6-pin	
797F925	NZD x C7 LFIC 7-pin	
797F935	NZD x M69 Schlage LFIC	
797F945	NZD x M08 SFIC	
798F115	PZD x plain	
798F125	PZD x cylinder or button	
798F135	PZD x emergency hole	
798F145	PZD x M09 Sargent® cylinder	
798F155	PZD x C6 LFIC 6-pin	
798F165	PZD x C7 LFIC 7-pin	
798F175	PZD x M69 Schlage® LFIC	
798F185	PZD x M08 SFIC	
LEVERS 2" to 2-1/4" Doors - D214		ALL FINISH
684F775	AZD x plain	\$168.00
684F785	AZD x cylinder or button	
684F795	AZD x emergency hole	
684F805	AZD x C6 LFIC 6-pin	
684F815	AZD x C7 LFIC 7-pin	
409F875	AZD x M08 SFIC	
684F825	NZD x plain	
684F835	NZD x cylinder or button	
684F845	NZD x emergency hole	
684F855	NZD x M09 Sargent® cylinder	
684F865	NZD x C6 LFIC 6-pin	
684F875	NZD x C7 LFIC 7-pin	
690F985	NZD x M69 Schlage® LFIC	
684F885	NZD x M08 SFIC	
798F215	PZD x plain	
798F225	PZD x cylinder or button	
798F235	PZD x emergency hole	
798F245	PZD x M09 Sargent® cylinder	
798F255	PZD x C6 LFIC 6-pin	
798F265	PZD x C7 LFIC 7-pin	
798F275	PZD x M69 Schlage® LFIC	
798F285	PZD x M08 SFIC	

PART NO.	DESCRIPTION	LIST PRICE
LEVER INSERT		ALL FINISH
598F809	Standard - 1-3/8" to 1-7/8" door	\$4.50
684F539	D214 - 2" to 2-1/4" door	\$67.00
MOUNTING SCREW PACK		
796F118	Standard - 1-3/8" to 1-7/8" door	\$7.40
797F818	D214 - 2" to 2-1/4" door	\$26.00
797F828	Standard - CL3880, 81, 90, 91	\$20.00
797F838	D214 - CL3880, 81, 90, 91	\$26.00
684F448	CL3850 (ALL FINISH)	\$16.00
684F528	CL3870	\$11.00
ROSES		ALL FINISH
678F252	Standard	\$73.00
598F592	Blank - CL3880, 81	\$46.00
ROSE LINER O/S		NO FINISH
678F248	Standard - 1-3/8" to 1-7/8" door	\$11.00
678F498	D214 - 2" to 2-1/4" door	
682F788	CL3880, 81	\$44.00
SCREW PACK FOR LATCH & STRIKE		ALL FINISH
604F228	For Latch & ANSI Strike	\$11.00
604F268	For Latch & 'T' or Full Lip Strike	\$11.00
STRIKES*		ALL FINISH
680L52	ANSI Curved Lip Blank Strike	\$37.00
586L19	T-Strike	
680L50	Full Lip Strike	
680L51	Full Lip Strike 1/4" Radius (Available Only 1-1/4" Lip)	\$24.00
STRIKE BOX		NO FINISH
025F858	Curved lip (T strike)	\$6.00
THUMBTURNS		ALL FINISH
586F512	Standard - 91	\$139.00
686F882	D214 - 91	

*Specify length and finish

LOCKSET PARTS

PART NO.	DESCRIPTION	LIST PRICE
SCREW PACKET		
605, 613E, 630		
556F558	for CK4350 †Order 50-	\$4.50
604F268	for curved lip strike	\$11.00
604F278	for curved lip strike x spanner head (M02)	\$23.00
604F288	for curved lip strike x Torx® head (M04)	
604F238	for spanner head (M02)	\$9.20
480F68	for SR118	
596F618	for SR118 & spanner head (M02)	\$23.00
596F628	for SR118 & Torx head (M04)	
604F228	standard	\$11.00
604F248	for Torx head (M04)	\$23.00
224F008*	Screw, Sems Assembly #8 -32 X 1-1/4" †Order 100-	\$4.50
STRIKE		
605, 613E, 630		
ANSI Curved Lip Strike		
217L13M016	1" Lip Length	\$37.00
217L13M018	1-1/8" Lip Length	
217L13M020	1-1/4" Lip Length	
217L13M022	1-3/8" Lip Length	
217L13M024	1-1/2" Lip Length	
217L13M028	1-3/4" Lip Length	
217L13M032	2" Lip Length	
217L13M036	2-1/4" Lip Length	
217L13M040	2-1/2" Lip Length	
217L13M044	2-3/4" Lip Length	
217L13M048	3" Lip Length	

PART NO.	DESCRIPTION	LIST PRICE
STRIKE (Cont'd)		
Curved Lip Box Strike		
586L19M016	1" Lip Length	\$37.00
586L19M018	1-1/8" Lip Length	
586L19M020	1-1/4" Lip Length	
586L19M022	1-3/8" Lip Length	
586L19M024	1-1/2" Lip Length	
586L19M028	1-3/4" Lip Length	
586L19M032	2" Lip Length	
586L19M036	2-1/4" Lip Length	
586L19M040	2-1/2" Lip Length	
586L19M044	2-3/4" Lip Length	
586L19M048	3" Lip Length	

†Sold only in multiples of the number indicated. Price is each.

CK4800 Series Standard Cylindrical Locksets

USA & Canada Prices Effective March 3, 2025

CK4800 SERIES

PART NO.	DESCRIPTION	LIST PRICE
STRIKES AND WROUGHT BOX		
ANSI TYPE		ALL FINISHES
217L13M016	1" Lip to Center	\$37.00
217L13M018	1-1/8" Lip to Center	
217L13M020	1-1/4" Lip to Center (standard)	
217L13M022	1-3/8" Lip to Center	
217L13M024	1-1/2" Lip to Center	
217L13M028	1-3/4" Lip to Center	
217L13M032	2" Lip to Center	
217L13M036	2-1/4" Lip to Center	
217L13M040	2-1/2" Lip to center	
217L13M044	2-3/4" Lip to Center	
217L13M048	3" Lip to Center	
CURVED LIP BOX TYPE STRIKE		
586L19M016	1" Lip Length	\$37.00
586L19M018	1-1/8" Lip Length	
586L19M020	1-1/4" Lip Length	
586L19M022	1-3/8" Lip Length	
586L19M024	1-1/2" Lip Length	
586L19M028	1-3/4" Lip Length	
586L19M032	2" Lip Length	
586L19M036	2-1/4" Lip Length	
586L19M040	2-1/2" Lip Length	
586L19M044	2-3/4" Lip Length	
586L19M048	3" Lip Length	
STRIKE		
680L50	Full Lip Strike	\$24.00

PART NO.	DESCRIPTION	LIST PRICE
ROSE		NO FINISH
579F11	Screw Packet & Strike Box	\$9.20
LATCH ASSEMBLY		ALL FINISHES
2-3/8" Backset		\$60.00
881F490	Plain, square corner	
881F480	Deadlocking, square corner	
2-3/4" Backset		
881F470	Plain, square corner	
881F460	Deadlocking, square corner	

LOCKSET PARTS					
PART NO.	DESCRIPTION	LIST PRICE	PART NO.	DESCRIPTION	LIST PRICE
BUSHING			HUB SPACER		
NO FINISH			NO FINISH		
194F228	Bushing	\$6.00	060F338	for UT5210, 61	†Order 50- \$4.50
BUTTON ASSEMBLY			LEVER		
612, 613, 619, 625, 626			612, 613, 619, 625, 626		
022F80	for UT5220	\$84.00	582F122	cyl/button LH	\$308.00
157F11	for UT5251		582F112	cyl/button RH	
156F43	for UT5261		582F142	cyl/button LH tactile	
CHASSIS COVER			582F132	cyl/button RH tactile	
NO FINISH			489F892	LFIC 6-pin LH	
138F888	Chassis Cover	\$11.00	489F882	LFIC 6-pin RH	
CHASSIS			549F362	LFIC 6-pin LH tactile	\$308.00
612, 613, 619, 625, 626			549F352	LFIC 6-pin RH tactile	
496F33	for UT5210	\$544.00	613F232	LFIC 7-pin LH	\$319.00
496F34	for UT5220		613F222	LFIC 7-pin RH	
496F32	for UT5251, 55, 57, 72		613F252	LFIC 7-pin LH tactile	
198F71	for UT5261		613F242	LFIC 7-pin RH tactile	
381F30	for UT5282		COUPLING		
CORE HOUSING			NO FINISH		
342F052	for 6-pin LFIC	\$19.00	131F278	Coupling	\$83.00
442F952	for 7-pin LFIC	\$16.00	EMERGENCY KEY		
613F352	for 6/7 pin Best-type LFIC	\$16.00	NO FINISH		
COUPLING			NO FINISH		
613F278	Coupling	\$83.00	679F818	for UT5220	\$4.50
ESCUTCHEON			GRIP RETAINER		
612, 613, 619, 625, 626			NO FINISH		
144F33	for inside lever	\$239.00	078F078	Grip Retainer	†Order 50- \$4.50
415F16	for outside knob		HUB		
144F34	for outside lever		NO FINISH		
605F90	for inside lever, lead lined		060F428	for all but UT5255	\$6.00
301F567	for outside lever, ext. lip 630 only		071F628	for UT5210	\$7.40
GRIP RETAINER			081F778	for UT5220	\$9.20
NO FINISH			147F078	for UT5251, 55, 72	\$6.00
078F078	Grip Retainer	†Order 50- \$4.50	140F978	for UT5251, 57, 72	
HUB			071F638	for UT5257	
NO FINISH			PIN		
060F428	for all but UT5255	\$6.00	NO FINISH		
071F628	for UT5210	\$7.40	171F798	Lever Spring Anchor	\$26.00
081F778	for UT5220	\$9.20	LEVER SPRING ANCHOR		
147F078	for UT5251, 55, 72	\$6.00	NO FINISH		
140F978	for UT5251, 57, 72		019F137	Pin, Spindle Drive	†Order 50-
071F638	for UT5257		156F837	Pin, UT5261 shank	†Order 50- \$4.50
LEVER			NO FINISH		
612, 613, 619, 625, 626			286F507	Pin, UT5282 spindle	†Order 50-
582F122	cyl/button LH	\$308.00	LEVER INSERT		
582F112	cyl/button RH		NO FINISH		
582F142	cyl/button LH tactile		613F029	Lever Insert	†Order 50- \$4.50
582F132	cyl/button RH tactile		LEVER SPRING ANCHOR		
489F892	LFIC 6-pin LH		NO FINISH		
489F882	LFIC 6-pin RH	\$319.00	PIN		
549F362	LFIC 6-pin LH tactile		NO FINISH		
549F352	LFIC 6-pin RH tactile	\$308.00	019F137	Pin, Spindle Drive	†Order 50-
613F232	LFIC 7-pin LH		156F837	Pin, UT5261 shank	†Order 50- \$4.50
613F222	LFIC 7-pin RH	\$319.00	286F507	Pin, UT5282 spindle	†Order 50-
613F252	LFIC 7-pin LH tactile		LEVER INSERT		
613F242	LFIC 7-pin RH tactile	\$308.00	NO FINISH		
613F112	plain LH		NO FINISH		
613F102	plain RH	\$341.00	NO FINISH		
613F152	plain LH tactile		NO FINISH		
613F142	plain RH tactile		NO FINISH		
613F132	priv. key hole LH		NO FINISH		
613F122	priv. key hole RH		NO FINISH		
613F172	priv. key hole LH tactile	\$341.00	NO FINISH		
613F162	priv. key hole RH tactile		NO FINISH		
613F432	SFIC prep LH	\$341.00	NO FINISH		
613F422	SFIC prep RH		NO FINISH		

†Sold only in multiples of the number indicated. Price is each.

UT5200 Series Pre-Assembled Unit Locksets

USA & Canada Prices Effective March 3, 2025

PART NO.	DESCRIPTION	LIST PRICE
PLUG DRIVER NO FINISH		
144F888	Plug Driver & Spindle Assembly UT5282	\$62.00
168F818	Plug Driver Assembly	\$38.00
144F298	Plug Driver UT5251, 57, 72	\$24.00
606F018	Plug Driver UT5255	\$23.00
145F328	Plug Driver UT5282	\$62.00
RETAINING RING NO FINISH		
251F198	Retaining Ring for UT5282 Spindle †Order 100-	\$4.50
SCREW 612, 619, 626, 613, 625		
480F70	Screw Pkt. (strike mount'g) †Order 20-	\$4.50
No Finish		
249F768	Screw, Fixed Escutcheon †Order 50-	\$4.50
092F789	Screw, Strike Adjustment (nylon) †Order 50-	
SHANK, LEVER NO FINISH		
102F198	for UT5210, 57 outside	\$73.00
102F378	for UT5220 inside	
114F678	for UT5220 outside	
188F758	for UT5251, 57, 72 outside	
188F738	for UT5251, 72 inside	\$83.00
605F768	for UT5255 inside	\$76.00
605F778	for UT5255 outside	\$76.00
156F658	for UT5261 inside	\$134.00
156F648	for UT5261 outside	\$92.00
102F278	for UT5282 inside	\$76.00
287F608	for UT5282 outside	\$112.00
SHANK RETAINER NO FINISH		
242F508	for lever †Order 50-	\$4.50

PART NO.	DESCRIPTION	LIST PRICE
SPINDLE NO FINISH		
201F188	for UT5220	\$11.00
144F308	for UT5251, 72	\$11.00
606F028	for UT5255	\$11.00
335F988	for UT5257	\$17.00
SPRING NO FINISH		
022F723	Spring, Button UT5220, 61 †Order 50-	\$4.50
103F458	Spring, Lever Return LH	\$16.00
103F448	Spring, Lever Return RH	\$16.00
060F053	Spring, Shoe UT5220, 61 †Order 100-	\$4.50
071F673	Spring, Spindle for UT5220 †Order 100-	\$4.50
249F773	Spring, Spindle for UT5251, 55, 57, 72 †Order 100-	\$4.50
261F118	Spring, Spindle for UT5282 †Order 100-	\$4.50
STRIKE 612, 613, 625, 626		
236L75M020	ANSI curved lip	\$36.00
610L44	ANSI straight lip	
610L43	ANSI straight lip for ext. esc.	
083L96M032	curved lip box, 2"	
083L96M036	curved lip box, 2-1/4"	
083L96M034	curved lip box, 2-1/8" (std)	
083L96M040	curved lip box, 2-1/2"	
083L96M048	curved lip box, 3"	
293L14	curved lip box for ext. lip esc.	
082L67	pairs of doors	
THROUGHBOLT		
222F85	Regular	\$9.20
223F29	Spanner head	\$9.20
THROW MEMBER NO FINISH		
320F442	for SFIC core	\$11.00
342F032	for Corbin Russwin core	\$11.00

† Sold only in multiples of the number indicated. Price is each.

Padlocks and Deadlocks

PADLOCKS			
PART NO.	DESCRIPTION	LIST PRICE	SOLD IN MULT. OF
422L842144	Chain & clevis, 9" brass	\$32.00	1
422L848144	Chain & clevis, 9" steel	\$30.00	1
303F242	Pin chamber cap	\$4.50	100
228F348	Plug retainer, oversize Spirol pin		100
244F647	Plug retainer, standard solid pin		20
405F772	Security disc		50
756F963	Throw member, LFIC models		\$15.00
DL4100 SERIES DEADLOCK PARTS			
PART NO.	DESCRIPTION	LIST PRICE	SOLD IN MULT. OF
796F46 x Fin	Outside Front	\$134.00	
796F30 x Fin	Thumbturn Assembly	\$111.00	
791F51 x Fin	Ergonomic Thumbturn Assembly	\$101.00	
Mouting Packs:			
791F82 Fin	Screw Pack - Standard Strike	\$32.00	
791F83 Fin	Spanner Head crew Pack - Standard Strike	\$23.00	
791F84 Fin	Torx Head Screw Pack - Standard Strike		
791F85 Fin	Screw Pack - ANSI Strike	\$7.40	
791F86 Fin	Spanner Head crew Pack - ANSI Strike	\$23.00	
791F87 Fin	Torx Head Screw Pack - ANSI Strike		
Strikes:			
796F34	Standard Strike	\$22.00	
240L08018	ANSI Strike 1-3/4" Door	\$32.00	
240L08020	ANSI Strike 2" Door		
240L08022	ANSI Strike 2-1/4" Door		
466F279	Strike Box	\$17.00	

DL3000 SERIES DEADLOCKS			
PART NO.	DESCRIPTION	LIST PRICE	SOLD IN MULT. OF
261F298	Allen wrench 5/64"	\$6.00	10
467F36	Bolt front	\$26.00	1
467F345	Cylinder housing	\$78.00	1
467F338	Cylinder housing screw	\$4.50	20
480F708	Screw pack for ANSI strike	\$4.50	20
480F69	Screw pack for strikes 424F83 and 394F19	\$6.00	20
283F81	Collar Base / Rose	\$72.00	1
424F838	Strike, 2-3/4" x 1-1/8"	\$36.00	1
394F198	Strike, 3-1/2" x 1-1/8"	\$31.00	1
423L71	Strike, ANSI 611,613, and all other finishes	\$44.00	1
416F38	Security collar	\$64.00	1
467F358	Bolt, less front -2-3/4" B.S.	\$67.00	1
693F208	Bolt, less front -2-3/8" B.S.		1
467F378	Strike box	\$11.00	1
496F718	Strike box	\$9.20	1

STRIKES				
PART #	DESCRIPTION	STANDARD DEVICE APPLICATION	ALTERNATE DEVICE APPLICATION	LIST PRICE
885F79	Curved Lip Strike RH D134 (1-1/4")	PED4600, PED5600		\$48.50
886F30	Curved Lip Strike LH D134 (1-1/4")			
886F31	Curved Lip Strike RH D200 (1-3/8")			
886F32	Curved Lip Strike LH D200 (1-3/8")			
886F33	Curved Lip Strike RH D214 (1-5/8")			
886F34	Curved Lip Strike LH D214 (15/8")			
886F35	Flat Lip Strike D134 (1-3/8")	N/A	PED4600, PED5600	\$46.20
886F36	Flat Lip Strike D200 (1-3/8")			
886F37	Flat Lip Strike D214 (1-5/8")			
886F38	Open Back Strike LHRB 1.750	N/A	PED4600, PED5600	\$113.90
886F39	Open Back Strike RHRB 1.750			
886F40	Open Back Strike LHRB 2.000			
886F41	Open Back Strike RHRB 2.000			
886F42	Open Back Strike LHRB 2.250			
886F43	Open Back Strike RHRB 2.250			
886F47	Bottom Strike	PED4800 A MD, PED5800 A MD, PED5600 A WD	PED4800 MD, PED4800 AD, PED5800 AD	\$82.40
887F02	Half Mortise Strike		PED4200, PED5200	\$82.40
887F07	Bottom Strike	PED5400		\$82.40
886F45	Top Strike for Aluminum frame	PED4800 NB AD, PED5800 NB AD	PED4800 NB MD, PED5800 NB MD, PED5800 NB WD	\$24.20
886F44	Top & Bottom Strike	PED4800 AD, PED5800 AD	PED4800 MD, PED5800 MD, PED5800 WD	\$48.40
887F03	Full Mortise Strike 1.750	N/A	PED4200, PED5200	\$82.40
887F04	Full Mortise Strike 2.250			
887F05	Surface or Double Dr Strike	N/A	PED4200, PED5200	\$106.60
887F08	Top Strike	PED5400 A, PED5400 A M03, PED5400 NB		\$111.50
887F09	Flush Panel Strike	N/A	PED5400 (A), PED5400 NB, PED5400 M03	\$121.20
887F01	Strike	PED4200 (A), PED5200 (A)	PED4200 (A), PED5200 (A)	\$114.00
886F48	Top Strike	PED4800 A (NB) MD, PED5800 (A) (NB) MD, PED5800 (A) (NB) WD	PED4800 (NB) AD, PED5800 (NB) AD	\$48.50
886F46	Top & Bottom Strike	PED4800 MD	PED4800 AD, PED5800 MD, PED5800 WD	\$96.90
887F10	Bottom Strike	PED5400 (A) FE	PED5400 A, PED5400 M03	\$96.90
887F11	Top Plate	PED5400 (A) HC		\$172.00
887F12	Bottom Strike	PED5400 A, PED5400 (A) HC, PED5400 (A) HC4, PED5400 M03	PED5400 (A) FE	\$48.50
886F49	Strike	PED4200	PED5200	\$48.50
887F00	Strike	PED4200	PED5200	\$155.20
887F13	Top Strike	PED5400 (A) FE, PED5400 (A) HC4		\$171.70

SHIM KITS		
PART	DESCRIPTION	LIST PRICE
875F42	PED5400 A Glass Bead Shim Kit, Flush	\$229.00
875F43	PED5400 A Glass Bead Shim Kit, Overlapping	
875F44	MTG PLT Shim For Flush End Cap	\$126.00
875F45	MTG PLT Shim For Overlapping End Cap	
875F46	PED5400 FE Glass Bead Shim Kit, Flush	\$237.00
875F47	PED5400 FE Glass Bead Shim Kit, Overlapping	
875F48	PED5400 Glass Bead Shim Kit, Flush	
875F49	PED5400 Glass Bead Shim Kit, Overlapping	
875F50	PED5600, PED5800 Glass Bead Shim Kit, Flush	\$188.00
875F51	PED5600, PED5800 Glass Bead Shim Kit, Overlapping	
875F52	PED4200, PED4600, PED4800 Shim Kit, Flush	\$179.00
875F53	PED4200, PED4600, PED4800 Shim Kit, Overlapping	

DEVICE PARTS			
PART NO.	DESCRIPTION	LIST PRICE	
ACTIVE HEAD (FIELD REVERSIBLE, WHERE HANDED)		NO FINISH	
650F378	ED4200	\$378.00	
681F618	ED4200S	\$401.00	
650F418	ED4400 LHR	\$397.00	
650F408	ED4400 RHR		
650F468	ED4800 LHR	\$414.00	
650F458	ED4800 RHR		
650F358	ED5200	\$378.00	
650F368	ED5200A	\$397.00	
706F038	ED5202 RHR	\$443.00	
706F048	ED5202 LHR		
706F058	ED5202A RHR	\$461.00	
706F068	ED5202A LHR		
681F608	ED5200S(A)	\$401.00	
706F078	ED5202S(A) RHR	\$467.00	
706F088	ED5202S(A) LHR		
650F398	ED5400(A) LHR	\$397.00	
650F388	ED5400(A) RHR		
650F428	ED5600(A)	\$378.00	
706F098	ED5602(A) RHR	\$443.00	
706F108	ED5602(A) LHR		
650F448	ED5800(A) LHR	\$414.00	
650F438	ED5800(A) RHR		
ARMORED FRONT 605, 606, 611, 612, 613, 619, 625, 626, 629, 630			
650F06	ED5600	\$27.00	
BAR & CARRIER ASSEMBLY		NO FINISH	
650F248	All 48"	\$437.00	
650F238	ED4000 36"	\$415.00	
650F228	ED5000 36"		
BAR CAP		NO FINISH	
650F189	Black nylon †Order 10-	\$7.40	
BOTTOM BOLT CASE		NO FINISH	
650F588	ED4400, ED5400	\$69.00	
650F598	ED5400A	\$73.00	
BOTTOM BOLT PACKET		NO FINISH	
650F778	ED4800	\$204.00	
698F038	ED5800(A)	\$179.00	
BOTTOM RAIL			
650F21	48"	\$262.00	
	606, 612, 630		
	605, 613		
	611, 625, 626, 629		
BOTTOM ROD & COUPLER ASSEMBLY		NO FINISH	
650F798	ED4800, ED5800(A)	\$152.00	
BOTTOM ROD & END PIN ASSEMBLY 605, 606, 611, 612 613, 618, 619, 625, 626, 629, 630, 722			
649F99 fin	Surface devices	\$244.00	
CARRIER BAR NO FINISH			
650F998	Internal	\$24.00	
COVER, ACTIVE HEAD 605, 606, 611, 612, 613, 619, 625, 626, 629, 630			
650F00	ED5200	\$305.00	
650F03	ED4200		
681F63	ED4200S		
650F04	ED4400		
650F05	ED4800		
681F62	ED5200S	\$323.00	
706F15	ED5602 RHR		
706F16	ED5602 LHR		
COVER, DELAYED EGRESS PC BOARDS			
704F269	DEED PC BD SA 36" NFPA-15	\$2,237.00	
704F279	DEED PC BD SA 36" NFPA-30		
704F479	DEED PC BD SA 36" BOCA-15		
704F489	DEED PC BD SA 36" BOCA-30		
704F569	DEED PC BD SA 48" NFPA-15		
704F579	DEED PC BD SA 48" NFPA-30		
704F589	DEED PC BD SA 48" BOCA-15		
704F599	DEED PC BD SA 48" BOCA-30		
COVER, BAR 605, 606, 611, 612, 613, 619, 625, 626, 629, 630			
650F07	36"	\$83.00	
650F08	48"		
COVER, END			
650F93	ED5000DB	\$544.00	
	605, 606, 611, 612, 613, 619, 625, 626, 629, 630		
650F14	ED4000 36" cyl. dogging	\$233.00	
	605, 606, 611, 612, 613, 619, 625, 626, 629, 630		
650F13	ED4000 36" standard	\$231.00	
	605, 606, 611, 612, 613, 619, 625, 626, 629, 630		
650F12	ED5000 36" cyl. dogging	\$233.00	
	605, 606, 611, 612, 613, 619, 625, 626, 629, 630		
650F11	ED5000(A) 36" standard	\$231.00	
	605, 606, 611, 612, 613, 619, 625, 626, 629, 630		
650F15	All 48" standard	\$250.00	
	605, 606, 611, 612, 613, 619, 625, 626, 629, 630		
650F16	All 48" cyl. dogging	\$252.00	
	605, 606, 611, 612, 613, 619, 625, 626, 629, 630		
COVER, TOP & BOTTOM LATCH			
650F64	ED4400, ED5400(A)	\$129.00	
	605, 606, 611, 612, 613, 619, 625, 626, 629, 630		
CYLINDER DOGGING KIT			
653F13	ED4000 36" bar	\$226.00	
	605, 606, 611, 612, 613, 619, 625, 626, 629, 630		
653F12	ED5000 36" bar	\$226.00	
	605, 606, 611, 612, 613, 619, 625, 626, 629, 630		
653F14	All 48" bar	\$239.00	
	605, 606, 611, 612, 613, 619, 625, 626, 629, 630		
DOGGING ASSEMBLY		NO FINISH	
650F968	Cylinder type	\$60.00	
650F528	Hex Key type		
DOGGING CYLINDER NUT		NO FINISH	
697F862	Dogging Cylinder Nut	\$24.00	

†Sold only in multiples of the number indicated. Price is each.

DEVICE PARTS (Cont'd)

PART NO.	DESCRIPTION	LIST PRICE
DOGGING CYLINDER SLEEVE		
650F959	Dogging Cylinder Sleeve	\$15.00
DOGGING HOLE PLUG		
650F279	Dogging Hole Plug †Order 50-	\$4.50
DOGGING KEY, HEX		
656F408	5/32"	\$6.00
END CAP RETROFIT KIT		
704F66	End Cap Retrofit Kit	\$129.00
END CAP		
704F62	End Cap	\$96.00
710F00M	Flush End Cap Retrofit Kit (M110)	\$119.00
END CLAMP PACKET		
592F338	ED4000, ED5000-D214	\$22.00
704F658	ED4200(S), ED5200S(A)	
704F648	ED4000, ED5000(A)	
FLUSH STRIKE TRANSOM BRACKET		
650F878	Flush strike transom brkt., ED5400(A)	\$83.00
LATCH PACKET		
654F218	Latch pkt, ED4400, ED5400 †Order 10-	\$7.40
MORTISE LOCK BODY		
655F488RR	ED5610 knob - RHR	\$516.00
655F488LR	ED5610 knob - LHR	
650F698RR	ED5602, ED5610, ED5655 lever - RHR	
650F698LR	ED5602, ED5610, ED5655 lever - LHR	
678F008RR	ED5610, ED5655 thumbpiece - RHR	
678F008LR	ED5610, ED5655 thumbpiece - LHR	
650F678RR	ED5650,57 knob, lever/thumbpiece - RHR	
650F678LR	ED5650,57 knob, lever/thumbpiece - LHR	
710F318LR	ED5634L - LHR	
710F318RR	ED5634L - RHR	
710F328LR	ED5634L - LHR - M91	\$886.00
710F328RR	ED5634L - RHR - M91	
710F338LR	ED5634L - LHR - M93	\$860.00
710F338RR	ED5634L - RHR - M93	
ADAPTER ASSEMBLY, MORTISE		
706F462	ED5602(A)	\$46.00
MOUNTING PACKET		
650F578	ED4400, ED5400(A)	\$136.00
654F208	Non-rated, wood door †Order 20-	\$6.00
900, WS700 & FE700 SERIES MULLION PACKETS		
TOP RETAINER AND SCREW PACKET		
713F518	972, 972A, 910A	\$320.00
713F938	FE772A, FE710A	\$331.00
713F948	972BKM, 910BKM	\$320.00
713F958	WS772AKM, WS708AKM	\$331.00
BOTTOM RETAINER AND SCREW PACKET		
713F528	972, 972A, 910A	\$211.00
713F998	FE772A, FE708A	\$331.00
713F988	972BKM, 910BKM	\$211.00
713F908	WS772AKM, WS708AKM	\$331.00
LOCKING MECHANISM PACKET		
744F258	972BKM, 910BKM	\$692.00
744F208	WS772AKM, WS708AKM	\$718.00
1-1/4" CYLINDER COLLAR PACKET¹		
447F43	972BKM ² , 910BKM ²	\$28.00
610F01	WS772AKM ² , WS708AKM ²	\$47.00
1-1/2" LFIC CYLINDER COLLAR PACKET¹		
609F37	972BKM ² , 910BKM ²	\$54.00
609F36	WS772AKM ² , WS708AKM ²	
Notes: 1. Cylinder collar packets contain a collar & spring washer. 2. Specify finish when ordering packets.		
PILLOW BLOCK PACKET		
650F978	Pillow Block packet, ED4400	\$73.00
POPPER KIT		
744F688	for ED5470, ED5860 M55	\$139.00
ROD & YOKE ASSEMBLY		
650F828	Rod & Yoke Assembly, concealed	\$178.00

PART NO.	DESCRIPTION	LIST PRICE
ROD EXTENSION KIT (CONCEALED VERTICAL)		
684F427	Rod Extension Kit, 24"	\$134.00
ROD EXTENSION KIT (SURFACE VERTICAL)		
Rod Extension Kit, 2"		
655F15	605, 606, 612, 613, 619, 625, 626, 629, 630	\$133.00
Rod Extension Kit, 6"		
655F16	605, 606, 612, 613, 619, 625, 626, 629, 630	\$152.00
Rod Extension Kit, 12"		
655F17	605, 606, 612, 613, 619, 625, 626, 629, 630	\$160.00
Rod Extension Kit, 24"		
684F42	605, 606, 612, 613, 619, 625, 626, 629, 630	\$163.00
ROD GUIDE COVER		
Rod Guide Cover		
650F63	605, 606, 612, 613, 619, 625, 626, 629, 630	\$52.00
ROD GUIDE PACKET		
Rod Guide Packet		
650F62	606, 612, 613, 626	\$31.00
SCREWS		
605, 606, 611, 612, 613, 619, 625, 626, 629, 630		
429F41	Pack, Armored Front†Order 20- 606, 612, 613, 619	\$7.40
704F63	Packet, Cover 606,612,613,630 finish	\$4.50
656F668	#10-24 x 1/4" PH †Order 100-	
650F538	Dogging Assembly †Order 50-	
650F518	Latch head to carrier†Order 50-	
650F288	Touch bar caps (622 only) †Order 50-	
650F508	Trim slide †Order 100-	
SCREW PACK, TORX® PIN		
701F60	ED4200(S), ED4800, ED5200(S), ED5800	\$27.00
701F61	ED4400, ED5400, ED5470	
701F62	ED5600	\$28.00
701F63	ED5860	\$27.00
SEX NUT PACKET		
652F298	Sex Nut Packet (4 sex nuts)	\$31.00
SHIM KIT		
697F338	ED5200(S)(A), ED5600(A), ED5800(A)	\$175.00
697F348	ED5400(A)	\$208.00
697F358	ED4200(S), ED4800	\$175.00
697F368	ED4400	\$208.00
SPRING, TOUCH PAD		
656F41	Spring, Touch Pad	\$6.00
STRIKE PACKET 622 FINISH ONLY		
650F888	bottom for 1/2" threshold (S09)	\$96.00
650F318	ED4200(S), ED4800	\$93.00
730F778	ED5200(S)(A), ED5202(S)(A)	\$132.00
650L65	ED5600	\$59.00
650L657020	Mortise strike for ED5602(A)	
653L157014	Mortise strike for doors with astragal	\$52.00
655F718	ED5200 x S02	\$96.00
653L163016	open back straight lip for 1-3/4" door	\$144.00
653L163020	open back straight lip for 2-1/4" door	\$191.00
653L183016	open back curved lip for 1-3/4" door	\$144.00
653L183020	open back curved lip for 2-1/4" door	\$191.00

†Sold only in multiples of the number indicated. Price is each.

Experience a safer
and more open world

DEVICE PARTS (Cont'd)

PART NO.	DESCRIPTION	LIST PRICE
TOP LATCH		
650F738	Top Latch & Bracket Assembly, ED4800	\$293.00
650F718	Top Latch & Bracket Assembly, ED5800	\$296.00
650F728	Top Latch & Bracket Assembly, ED5800A	\$318.00
650F558	Top Latch, ED4400, ED5400, ED5470	\$277.00
650F568	Top Latch, ED5400A, ED5470B	\$291.00
681F768	Top Latch, ED5860B	\$331.00
681F718	Top Mtg. Plate for ED5470B	\$83.00
TOP ROD NO FINISH		
650F818	Top Rod Tube, concealed	\$151.00
650F808	Top Rod, concealed	\$129.00
Top Rod, surface		
650F60 fin	605, 606, 611, 612, 613, 619, 625, 626, 629, 630	\$201.00

PART NO.	DESCRIPTION	LIST PRICE
TOP STRIKE PACKET		
650F548	Top strike packet	\$126.00
681F708	Top strike packet for ED5470B	\$47.00
681F778	Top strike for ED5860B	\$54.00
TOUCH PAD CAP 622 ONLY		
724F278	Touch Pad Cap, front	\$54.00
650F095	Touch Pad Cap, rear	\$45.00
TRIM SLIDE NO FINISH		
650F498	Trim Slide Retainer †Order 10-	\$7.40
650F489	Trim Slide, ED4000	\$11.00

TRIM PARTS, GRIPS

DESIGN	STANDARD PART NO.	STANDARD PRICE 605, 606, 611, 612, 613, 619, 625, 626, 629, 630	KNURLED PART NO.	KNURLED PART PRICE	ABRASIVE PART NO.	ABRASIVE PART PRICE		
A7	652F78	\$261.00	652F79	\$359.00	652F80	\$323.00		
C7	652F66		652F67		652F68			
D7 RHR	652F69		652F70		652F71			
D7 LHR	652F72		652F73		652F74			
E7	652F57		652F58		652F59			
L7	652F60		652F61		652F62			
N7	652F75		652F76		652F77			
PR7	652F81		652F82		652F83			
R7	652F63		652F64		652F65			
A7M	653F71		653F72		653F73			
C7M	653F59		653F60		653F61			
D7M RHR	653F62		653F63					
D7M LHR	653F65		653F66					
E7M	653F50							
L7M	653F53							
N7M	653F68							
PR7M	653F74							
R7M	653F56							
A8	653F05							
C8	652F93						652F95	
D8 RHR	652F96							
D8 LHR	652F99							
E8	652F84				652F85		652F86	
L8	652F87				652F88		652F89	
N8	653F02				653F03		653F04	
PR8	653F08				653F09		653F10	
R8	652F90						652F92	
08, 014	656F53				n/a			n/a

†Sold only in multiples of the number indicated. Price is each.

TRIM PARTS, GRIPS, ESCUTCHEONS (Cont'd)

DESIGN	STANDARD PART NO.	STANDARD PRICE 605, 606, 611, 612, 613, 619, 625, 626, 629, 630	KNURLED PART NO.	KNURLED PART PRICE	ABRASIVE PART NO.	ABRASIVE PART PRICE
A9	677F16	\$261.00	652F79	\$359.00	652F80	\$323.00
C9	677F15		652F67		652F68	
D9 RHR	677F26		652F70		652F71	
D9 LHR	677F27		652F73		652F74	
E9	677F13		652F58		652F59	
L9	677F04		652F61		652F62	
N9	677F05		652F76		652F77	
PR9	677F28		652F82		652F83	
R9	677F14		652F64		652F65	
A9M	653F71		653F72		653F73	
C9M	653F59		653F60		653F61	
D9M RHR	653F62		653F63			
D9M LHR	653F65		653F66			
E9M	653F50					
L9M	653F53		653F54		653F55	
N9M	653F68		653F69		653F70	
PR9M	653F74		653F75		653F76	
R9M	653F56		653F57			

DESIGN	PART NO.	LIST PRICE 605, 606, 613, 625, 626
FR9 RHR	698F64	\$293.00
FR9 LHR	698F66	
TS9	698F31	
Z9 RHR	698F68	
Z9 LHR	698F70	
M9	698F33	\$267.00
FR9M RHR	698F65	\$293.00
FR9M LHR	698F67	
TS9M	698F32	
Z9M RHR	698F69	
Z9M LHR	698F71	
M9M	698F34	\$267.00

PART NO.	DESCRIPTION	605, 606, 611, 612, 613, 613E, 619, 625, 626, 629, 630
656F58	x8 cyl. x thumbturn	\$213.00
656F59	x8 cyl. x lever	\$226.00
656F60	x8 plain x thumbturn	\$213.00
656F61	x8 plain x lever	\$226.00
651F00	F450	\$205.00
651F01	F457	
651F10	O14, T14 bottom	\$96.00
656F62	O1410 top	\$205.00
656F63	O1455/59 top	
651F09	T1410 top	\$185.00
651F06	T1450 top	\$179.00
651F08	T1455, T1459 top	\$185.00
651F04	T1457 top	\$179.00
733F41	F950	\$293.00
733F42	F957	
733F43	9M10, M50	
733F05	L910	
733F44	L950	
733F45	L955	
783F06*	L955 L959	
733F46	F9M57	
733F47	L957	
733F48	DL910	
733F49	DL9M10, DL9M50	
733F50	DL955, DL959	
733F51	DL9M55, DL9M57	
733F52	DL957	
733F53	DL950	

†Sold only in multiples of the number indicated. Price is each.
 *Not available in 630 Finish.

ED4000/ED5000 Series Pushpad Exit Devices

USA & Canada Prices Effective March 3, 2025

TRIM PARTS (Cont'd)

PART NO.	DESCRIPTION	LIST PRICE
BUSHING, NYLON NO FINISH		
652F239	Bushing, Nylon †Order 20-	\$7.40
CLUTCH LEVER NO FINISH		
651F538	Clutch Lever †Order 20-	\$7.40
COTTER PIN NO FINISH		
677F098	Cotter Pin †Order 100-	\$4.50
COVER PLATE NO FINISH		
651F858	Cover Plate, x8, O14, T14	\$23.00
CYLINDER COLLAR		
	various	see page 379
GEAR & BLACK HOUSING ASSEMBLY NO FINISH		
651F638	Gear & Black Housing Assembly (all but x750)	\$26.00
651F648	Gear, levers	\$11.00
655F548	Gear, dummy lever	
HEX NUT/BUSHING NO FINISH		
651F398	Hex Nut/Bushing for spring	\$9.20
HOUSING NO FINISH		
651F675	Housing & Cam Assembly, x755, T1355	\$70.00
651F965	Housing & Cam Assembly, x855, x859, O/T1455/59	\$56.00
651F425	Housing, Cylinder, F2, F3, T1357, O/T1457	\$11.00
651F545	Housing, Tailpiece Assembly	\$47.00
706F015	Housing, Cylinder ED5202(S)(A), ED5602(A)	\$15.00
706F005	Housing, Cylinder, Trim, ED5202(S)(A), ED5602(A)	\$69.00
HUB NO FINISH		
652F228	Hub	\$38.00
651F655	Hub, lever	\$11.00
656F64	Hub, G knob	
LOCK WASHER NO FINISH		
651F448	for screw post †Order 50-	\$4.50
NUT NO FINISH		
651F888	Nut, Cover Plate †Order 50-	\$4.50
651F928	Nut, Spring Post	\$9.20
PIN NO FINISH		
651F838	Pin, Clutch Lever †Order 50-	\$4.50
651F988	Pin, Groove, 5/32" x 1-1/8" for T1410, T1455, T145 †Order 50-	
651F587	Pin, Thumbpiece, T13M †Order 20-	
PULL		
651F372	Pull, Offset - 605, 606, 611, 612, 613, 619, 625, 626, 629, 630	\$218.00
651F362	Pull, Straight - 605, 606, 611, 612, 613, 619, 625, 626, 629, 630	\$179.00
RACK & TAILPIECE ASSEMBLY NO FINISH		
651F828	x810, x855, x859, O14, T14	\$138.00
652F218	x850	\$120.00
RETAINER, CLUTCH LEVER PIN NO FINISH		
651F898	Retainer, Clutch Lever Pin †Order 100-	\$4.50
RETAINING RING NO FINISH		
651F608	Retaining Ring, T13M †Order 50-	\$4.50
ELECTRIFIED LOCKBODY USED WITH "SAF" & "SEC" ED5600L DEVICES:		
677F768LR 626	LOCK SA-L5 MORT.SAFE LHR	\$1,259.00
677F768RR 626	LOCK SA-L5 MORT.SAFE RHR	
677F778LR 626	LOCK SA-L5 MORT.SEC. LHR	
677F778RR 626	LOCK SA-L5 MORT.SEC. RHR	
SCREW NO FINISH		
655F028	Screw, Cylinder Mounting †Order 100-	\$4.50
651F878	Screw, FHM-PH #8-32 x 7/16" †Order 50-	

PART NO.	DESCRIPTION	LIST PRICE
SCREW (CONT'D) NO FINISH		
656F658	Screw, Function	\$4.50
651F418	Screw, RHM-PH #1/4-20 x 5/8" †Order 50-	
651F508	Screw, Tailpiece Plate, PHT-T-PH #6 x 3/8 †Order 50-	
SCREW PACKET, MOUNTING		
652F128	1-3/4" - 2" door - 606, 612, 613, 619, 626	\$15.00
652F108	1-3/4" - 2" door - 606, 612, 613, 619, 626	\$11.00
652F118	2-1/4" door - 606, 612, 613, 619, 626	
652F138	2-1/4" door - 606, 612, 613, 619, 626	\$15.00
652F148	F3, T13 for 1-3/4" - 2" door - 606, 612, 613, 619, 626	\$19.00
652F158	F3, T13 for 2-1/4" door - 606, 612, 613, 619, 626	
SCREW POST NO FINISH		
783F048	Screw Post	\$11.00
SLIDER, THUMBPIECE NO FINISH		
651F498	Slider, Thumbpiece	\$11.00
SPINDLE BRACKET NO FINISH		
652F048	Spindle Bracket, lever	\$11.00
SPINDLE NUT NO FINISH		
651F738	Spindle Nut, x7 †Order 20-	\$4.50
652F098	Spindle Nut, x7M lever †Order 50-	
SPINDLE WASHER NO FINISH		
652F068	Spindle washer, G Knob	\$7.40
652F058	Spindle Washer, Levers	\$7.40
SPRING NO FINISH		
651F948	Spring, Extension	\$4.50
651F758	Spring, Grip Return, knob †Order 10-	\$7.40
651F618	Spring, Grip Return, lever, LHR (red)	
651F628	Spring, Grip Return, lever, RHR (blue)	
651F938	Spring, Rack, lever †Order 50-	\$4.50
651F478	Spring, Thumbpiece, T13	\$9.20
678F028	Spring, Thumbpiece T13M	\$11.00
651F408	Spring, various trim †Order 20-	\$4.50
651F868	Spring, various trim †Order 50-	
TAILPIECE ASSEMBLY NO FINISH		
677F068	1-3/4" door without shim kit	\$62.00
655F698	2" - 2-1/4" door or 1 3/4" door with shim kit - TH9 series trims	
655F708	2" - 2-1/4" door or std. door with shim kit - All trims except TH9 series	
THIMBLE INSERT		
651F389	Knob & thumbturn †Order 50-	\$4.50
118F299	Lever †Order 100-	
THUMBPIECE BRACKET		
651F578	Thumbpiece Bracket, T13M	\$31.00
THUMBPIECE TAB NO FINISH		
651F568	Thumbpiece Tab, T13M	\$6.00
THUMBPIECE 605, 606, 611, 612, 613, 619, 625, 626, 629, 630		
566F50	Thumbpiece, T13, T14	\$73.00
566F51	Thumbpiece, T13M	\$84.00
WASHER NO FINISH		
651F708	Washer under tailpiece †Order 50-	\$4.50
651F848	Washer, Grip †Order 20-	

STRIKES FOR CROSSBAR EXIT DEVICES		
PART NO.	DESCRIPTION	LIST PRICE
269F73	ED7000 LHR with dogging	\$1,337.00
269F74	ED7000 RHR with dogging	
269F75	ED7000 LHR less dogging	\$1,263.00
269F76	ED7000 RHR less dogging	
VERTICAL ROD STRIKES 605, 606, 612, 613, 622, 626, 629		
392F24	Top	\$145.00
392F22	Top	\$114.00
392F28	Bottom flush	\$94.00
392F29	Bottom surface	\$78.00
176F653	Top bracket	
304F337	Bottom 630 only	\$52.00
304F347	Bottom 630 only	\$78.00
352F042	Bottom	\$52.00
352F05	Top	\$94.00
361F913	Bottom flush	
123F22	Bottom	
183F857	Top 630 only	
502F75	Bottom mortised	\$55.00
502F96	Surface	\$71.00

STRIKES FOR CROSSBAR EXIT DEVICES (Cont'd)		
PART NO.	DESCRIPTION	LIST PRICE
CONCEALED VERTICAL ROD STRIKES 605, 606, 612, 613, 622, 626		
503F52	Bottom Strike	\$96.00
503F533	Fire Rated Bottom Strike	
RIM EXIT DEVICE STRIKES 605, 606, 612, 613, 622, 626		
142F43	Adj. Packet	\$215.00
467F733	Pack, rim vert. rod	\$145.00
300F71	Packet	\$184.00
499F598	Adj.	\$136.00
MORTISE STRIKES 605, 606, 612, 613, 619, 622, 625, 626		
240L50	Stainless Mortise - LHR 629, 630 only	\$76.00
240L51	Stainless Mortise - RHR 629, 630 only	
411L63	Open Back - RHR	\$171.00
411L62	Open Back - LHR	
LOW PROFILE EXIT DEVICE STRIKES		
436F038	Strike, bottom	\$28.00
487M048589	Top Rod (for 10' Doors)	\$205.00
463F918	Flush Bottom Strike	\$32.00

DEVICE PARTS

PART NO.	DESCRIPTION	LIST PRICE
122F188	Mounting Bracket	\$47.00
122F248	Washer †Order 100-	\$4.50
122F413	Lower Rod Guide	\$20.00
122F508	Lower Bolt Tube Sub Assembly	\$133.00
122F518	Bottom Guide Sub Assembly	\$127.00
122F568	Locking Lever	\$36.00
122F578	Locking Lever	\$26.00
122F593	Locking Lever Spring	\$38.00
122F608	Locking Hub	\$22.00
122F618	Locking Hub	\$11.00
122F639	Spacer Washer (Nylon)	\$4.50
122F643*	Handle Lever	\$184.00
123F538	Dogging Key, 3/16" hex	\$6.00
129F499	Sound Deadener	\$11.00
129F848	Cylinder Nut	
134F05	Cylinder Collar	\$54.00
140F528	Stud †Order 20-	\$4.50
141L548	Reinforcing Tube	\$225.00
141L59	Crossbar	
	605, 606, 611, 612, 613, 619, 622, 625, 626, 629, 630	\$510.00
142F44*	Adj. Strike	\$119.00
143F248	Spring †Order 50-	\$4.50
145F543*	Strike Plate	\$130.00
148F367	Release Plunger Sub Assembly	\$37.00
148F448	Mounting Wrench	\$9.20

PART NO.	DESCRIPTION	LIST PRICE
164F329	Nylon Washer †Order 50-	\$4.50
173F698	Stud	
173F728	Nut	\$9.20
175F518	Rod Insert	\$31.00
183F74	Top Latch Sub Assembly (with top rod doors 6'4" to 8'6")	\$589.00
183F75	Top Latch Sub Assembly (with top rod door 8'6" to 10'8")	\$589.00
184F825	Shim	\$31.00
184F948	Jam Nut	\$11.00

DEVICE PARTS (Cont'd)

PART NO.	DESCRIPTION	LIST PRICE
213F117	Top Strike S/A (reveal less 5-1/2") <i>Obsolete</i> 629, 630	\$141.00
200F168	Screw 12-24 x 1/2" FHMS <i>Obsolete</i>	\$4.50
220F498	Screw 1/4-20 x 2" FHMS <i>Obsolete</i>	
220F722	Screw 12-24 x 1/2" FHMS-PH <i>Obsolete</i> †Order 20-	
220F75	Screw 1/4-20 x 5/8" FHMS-PH 606, 619, 622, 625, 626, 630	
	605, 611, 512, 613, 629	\$6.00
220F778	Screw 622, CDC, MTD, 613	\$4.50
220F827	Screw 1/4-20 x 1" FHMS-PH	\$6.00
220F848	Screw 12-24 x 1-1/4" FHMS-PH	\$4.50
220F85*	Screw 1/4-20 x 1-1/4" FHMS-PH x Anchor <i>Obsolete</i>	\$6.00
221F948*	Mounting Screw	
222F71*	Throughbolt	
224F348	Screw 12 x 1" FHWS †Order 20- <i>Obsolete</i>	\$4.50
224F392	Screw 14 x 1-1/4" FHWS †Order 20- <i>Obsolete</i>	
224F448	Screw 14 x 1-1/2" FHWS <i>Obsolete</i>	\$6.00
224F508	Screw 14 x 2" FHWS †Order 20- <i>Obsolete</i>	\$4.50
225F998	Screw 12 x 1-1/2" OHWS-PH <i>Obsolete</i>	
228F188	Roll Pin †Order 100- <i>Obsolete</i>	
228F497	Roll Pin (79028-1250343)	
228F517	Roll Pin (79028-1250500 St'd) †Order 100-	
228F528	Roll Pin †Order 100- <i>Obsolete</i>	
228F558	Roll Pin 1/8 x 3/4" †Order 100- <i>Obsolete</i>	
228F687	Roll Pin 156 x 9/16" †Order 50-	
228F808	Roll Pin 187 x 3/4" †Order 100-	
228F817	Roll Pin 187 x 1-15/16" †Order 20-	
228F847	Roll Pin 187 x 1-3/8" †Order 20-	
243F769	Stop Nut †Order 20- <i>Obsolete</i>	\$6.00
243F798	Spring Lock Washer †Order 100- <i>Obsolete</i>	
243F808	1/4-20 x 5/8" FRMS-PH <i>Obsolete</i>	
243F85	Top Cover Sub Assembly 605, 606, 611, 612, 613, 619, 625, 626, 629, 630 <i>Obsolete</i>	\$233.00
	249F33*	1/4-20 NC-2A x 1-1/4" Lg. Phillips OHMS
253F118	Drive Screw †Order 100-	\$4.50
254F73	Screw 8-32 x 3/8" OHMS-PH <i>Obsolete</i> 605, 606, 611, 612, 613, 619, 625, 626, 630	\$4.50
	255F41*	Screw 12-24 x 2" FHMS-PH
261F288	Screw 8-32 x 3/8" HSS Cone-SOC <i>Obsolete</i>	\$6.00
261F318	Screw 5/16-24 x 1-1/2" FHMS-SOC 605, 611, 612, 613, 619, 625, 626, 630	\$6.00
	261F54	Cylinder Collar
261F658	Screw 1/4-20 x 1/2" PHMS	\$6.00
262F901	River 3/32" x 5/32" †Order 100- <i>Obsolete</i>	\$4.50

PART NO.	DESCRIPTION	LIST PRICE
264F958	Screw 12-24 x 7/8" RHMS-PH <i>Obsolete</i> (Metal Doors) †Order 20-	\$4.50
268F647	Washer †Order 50-	
268F848	Screw 6-32 x 5/8" RHMS †Order 20- <i>Obsolete</i>	
268F878	Retainer Ring †Order 20-	
269F048	Cotter Pin †Order 50-	
269F058	Lockwasher †Order 100-	
269F08	Screw 8-32 x 3/8" FHMS-PH 605, 606, 611, 613, 619, 625, 626, 630	\$4.50
	Lever	
269F31	605, 606, 611, 612, 619, 613, 619, 625, 626	\$480.00
269F32	605, 606, 611, 612, 619, 613, 619, 625, 626	
COVER		
269F33	605, 606, 611, 612, 613, 619, 625, 626, 629, 630	\$496.00
269F34	605, 606, 611, 612, 613, 619, 625, 626, 629, 630	
269F35	605, 606, 611, 612, 613, 619, 625, 626, 629, 630	
269F36	Active Case Less Cover, ED7200 RHR & LHR 605, 606, 611, 612, 613, 619, 625, 626, 629, 630	\$535.00
	269F378	Hub
269F393	Latch Retractor	\$59.00
269F403	Latch Retractor	\$64.00
269F413	Slide	\$76.00
269F42	Inactive Case S/A, all ED7000 605, 606, 611, 612, 613, 619, 625, 626, 629, 630	\$532.00
	269F468	Hold Back Sleeve
269F479	Nyliner	\$6.00
269F488	Lever Pivot	\$7.40
269F499	Bushing	\$9.20
269F528	Hub Shank	\$6.00
269F538	Latch Spring	\$6.00
269F549	Button	\$4.50
269F559	Washer †Order 50-	
269F569	Washer †Order 50-	
269F578	Spring Washer	\$11.00
269F587	Latch Pin	\$6.00
269F608	Inner Spring	\$11.00
269F91*	Screw Packet	\$147.00
269F92*	Screw Packet	\$109.00
270F01*	Screw Packet	\$147.00
270F02*	Screw Packet	\$112.00
270F11*	Through Bolt	\$7.40
282F325	Caulking Anchor <i>Obsolete</i>	
282F357	Caulking Anchor	\$6.00
284F67*	Lever RH <i>Obsolete</i>	\$188.00

*Specify Finish. Ø Subject to availability.
† Sold only in multiples of the number indicated. Price is each.

DEVICE PARTS (Cont'd)

PART NO.	DESCRIPTION	LIST PRICE	PART NO.	DESCRIPTION	LIST PRICE
284F977	Roll Pin †Order 50-	\$4.50	351F72	Bottom Latch Cover 605, 606, 611, 612, 613, 619, 625, 626, 629, 630	\$361.00
291F498	Stop Plate	\$38.00	351F73	Top Latch Cover 605, 606, 611, 612, 613, 619, 625, 626, 629, 630	\$382.00
291F578	Screw 10-31 x 1" FHM-PH †Order 50-	\$4.50	351F797	Top Latch Sub Assembly	\$86.00
293F183	Slide Assembly	\$175.00	351F807	Roll Pin †Order 50-	\$4.50
306F068	Screw 10-24 x 5/16" RHMS-PH †Order 20-	\$4.50	351F823	Top Latch Backplate	\$160.00
306F078	Spring Lockwasher †Order 100-		351F833	Top Latch Slide	
321F907	Dogging Device Sub Assembly	\$71.00	351F849	Spacer	\$16.00
333F519	Screw	\$4.50	351F85*	Top Latch Sub Assembly No Cover	\$604.00
341F318	Shim	\$32.00	351F867	Bottom Latch	\$160.00
351F50*	Active Case - less cover, ED7400 standard		351F873	Latch Link	\$154.00
	606, 612, 619, 622, 626	\$331.00	351F883	Bottom Latch Backplate	\$160.00
	605, 611, 613, 625, 629, 630		351F897	Spring †Order 20-	\$4.50
351F51*	Active Case - less cover, ED74000, ED7401, no bottom rod		351F907*	Bottom Latch Sub Assembly	\$544.00
	606, 612, 619, 622, 626	\$331.00	351F988	Rod Connector Sub Assembly	\$9.20
	605, 611, 613, 625, 629, 630		352F021	Drive Rivet †Order 20-	\$4.50
351F528	10-32 x 7/16" FHUMS-PH Screw †Order 100-	\$4.50	352F068	1/4-20 x 3/4" BHUMS-PH Screw †Order 20-	
351F553	Slide Sub Assembly	\$249.00	361F308	Anchor	\$11.00
351F56*	Active Case Sub Ass'y, ED7400 with dogging -RHR	\$1,370.00	362F498	Nut	\$37.00
351F57*	Active Case Sub Ass'y, ED7400 with dogging -LHR		362F918	Plate	\$11.00
			364F228	Washer	\$11.00
			364F272	Locking Slide	\$44.00
			364F288	Locking Lever Sub Assembly	\$56.00
			364F308	Lifting Lever	\$46.00
			364F36*	Escutcheon Assembly RHR, C4, D4, E4 - MR	\$460.00
			364F37*	Escutcheon Assembly LHR, C4, D4, E4 - MR	
			364F38*	Escutcheon Assembly RHR, C4, D4, E4 - Std	\$482.00
			364F39*	Escutcheon Assembly LHR, C4, D4, E4 - Std	
			365F003	Slide Extension S/A Door 1-3/4"	\$71.00
			365F013	Slide Extension S/A Door 2-1/4"	
			365F033	Slide Extension S/A Door 1-3/4" or Lever Trim	
			365F98*	1/4-20 x 2" OHTS-F-PH Metal Door	\$11.00
				Latch Sub Assembly	
			376F42	611, 612, 613, 619, 625, 626	\$83.00
				605, 606, 629, 630	\$99.00
			378F745	Tenon Sub Assembly Packet	\$69.00

*Specify Finish. Subject to availability.

† Sold only in multiples of the number indicated. Price is each.

DEVICE PARTS (Cont'd)

PART NO.	DESCRIPTION	LIST PRICE	PART NO.	DESCRIPTION	LIST PRICE
392L19*	Adj. Bottom Rod Assembly	\$355.00	468F246	Active Backplate Assembly, RH	\$1,263.00
393L13-M672*	Top Rod	\$277.00	468F256	Active Backplate Assembly, LH	
399F188	Lower Bolt Assembly	\$550.00	468F266	Active Backplate Assembly, RH	
402F99*	Thumbpiece	\$72.00	468F276	Active Backplate Assembly, LH	
403F035	Slide x4M Trim	\$141.00	468F355	Cylinder housing	\$16.00
403F30*	Washer	\$6.00	480F128	Inactive Backplate Assembly	\$168.00
405F428	Anchor	\$11.00	480F13*	Lever	\$425.00
405F458	Mullion (507) 7'2" door	\$374.00	480F188	Spindle	\$70.00
Ø 405F466	Bottom Plate	\$168.00	480F198	Nut	\$16.00
405F476	Top Plate	\$151.00	480F208	Rollback	\$17.00
405F496	Bottom Plate Assembly				
Ø 409F836	Top Plate Assembly				
412F133*	Screw, 8-32 x 5/16"	\$6.00	480F28*	Lever & Spindle Assembly	\$396.00
412F157	Lever Pivot	\$20.00	480F30*	Lever & Spindle Assembly	
412F167	Deadlocking Plunger	\$32.00	480F33*	Lever & Spindle Assembly	\$400.00
412F451	Inactive Backplate Assembly	\$165.00	480F375	Slide	\$78.00
416F818	Stud	\$15.00	482F442	*Bushing	\$86.00
418F288	Dogging Screw	\$11.00	482F49*	Escutcheon	
418F308	Rivet	\$6.00	482F73*	Escutcheon & Bushing	\$400.00
418F352	Hub	\$76.00	484F418	Rollback	\$27.00
418F368	Lever, RH	\$9.20	484F898	Knob Shank Sub Assembly	\$52.00
418F378	Lever, LH				
420F128*	Screw Packet	\$71.00	492F195	Slide	\$138.00
433F978	Lever Pivot	\$69.00	BLANK PLATE FOR STOCK HOLLOW METAL DOORS		
433F988	Lever Pivot				
434F008	Lever Pivot	\$38.00	561F29	Blank Plate 14" x 3-1/2" Used on the outside of stock cut-out hollow metal doors where no trim is desired 605, 606, 612, 613, 619, 625, 626, 630	\$209.00
434F028	Screw 1/4-20 x 3/4" BUHC-SK	\$4.50	BLANK FRONTS AND STRIKES FOR STOCK HOLLOW METAL DOORS AND FRAMES		
464F028	Mullion (508) 8' door	\$363.00	Steel, USP		
464F915	Active Case Casting only	\$71.00	077F198	Front, 2-1/4" x 1-1/8"	\$15.00
467F942	Thumbpiece Lever RH	\$130.00	334F99	Front, 8" x 1-1/4"	\$32.00
467F952*	Thumbpiece Lever LH				
468F022*	Lever, inactive RH	\$192.00	Ø 236L718018	Strike, 4-7/8" x 1-1/4"	\$15.00
468F032*	Lever, inactive LH				
468F122	Thumbpiece Lever Assembly RH	\$331.00	321F24*	RHR Bracket for P3 trim	\$168.00
468F132	Thumbpiece Lever Assembly LH				
468F147	Latch Pin Assembly RH	\$130.00	393L13-M672*	Top Rod	\$277.00
468F157	Latch Pin Assembly LH				
468F162	Lever Assembly RH	\$121.00	Ø 399F168	Spindle Adapter	\$74.00
468F172	Lever Assembly LH				
468F202*	Lever Assembly RH	\$305.00	399F178	Lower Rod Assembly	\$277.00
468F212*	Lever Assembly LH				
			402F983	Extension Slide	\$55.00
			402F99*	Thumbpiece	\$72.00
			408F258	Guide Spring	\$4.50
			503F533	Bottom Strike	\$96.00
			503F557	Top Strike	\$88.00
			503F567	Top Strike - Fire Rated	
			376F37*	Sex Nut (For 1-3/4 & 2" doors)	\$11.00
			MISCELLANEOUS		
			148F228	Pin	\$4.50

*Specify Finish. Ø Subject to availability.
 † Sold only in multiples of the number indicated. Price is each.

DC3000/DC5200 Series Door Closers

USA & Canada Prices Effective March 3, 2025

DC3000 CLOSER PARTS		
PART NO.	DESCRIPTION	LIST PRICE
TOOLS		
330F10	Hex wrench for closer valve, 3/32"	\$7.90
597F24	Torx tool kit	\$319.00
CLOSER BODIES 600, 689, 690, 691, 693, 696		
540F27	Closer body for DC3200	\$476.00
597F35	Closer body for DC3200 x M71	\$539.00
M71 = Delayed action		
ARMS 600, 689, 690, 691, 693, 696		
688F95	Regular arm	\$192.00
688F77	Regular arm with hold-open	\$284.00
688F95	Top jamb	\$192.00
688F77	Top jamb with hold-open	\$284.00
689F02	Heavy-duty parallel arm	\$289.00
689F01	Heavy-duty parallel arm with hold-open	\$323.00
597F52	Heavy-duty regular arm	\$289.00
689F03	Heavy-duty parallel arm with backstop	\$318.00
689F04	Heavy-duty parallel arm with backstop & hold-open	\$380.00
691F98	Reg. secondary arm assy.	\$71.00
691F99	Deep reveal secondary arm assembly	\$72.00
692F02	Reg. H.D. secondary arm assembly	\$268.00
692F03	Deep reveal H.D. secondary arm assembly	\$463.00
BRACKETS 600, 689, 690, 691, 693, 696		
188F03	Quik-Install™	\$30.00
188F41	Parallel arm	\$39.00
509F49	Parallel arm with hold-open	\$70.00
188F62	Parallel arm offset	\$47.00
188F63	Parallel arm for flush transom	\$70.00
244F17	Regular arm mortise	\$84.00
447F14	Angle Support Bracket and Spacer	\$70.00
DROP PLATES 600, 689, 690, 691, 693, 696		
188F65	For DC3220 x full cover	\$111.00
597F58	For DC3210 x full cover	
COVERS 600, 689, 690, 691, 693, 696		
597F78	Full cover and insert packet (standard)	\$66.00
PAINT (PER CAN)		
597F94	Silver Aluminum - 689	\$88.00
597F95	Dark Bronze - 690	
597F96	Light Bronze - 691	
597F97	Satin Brass - 696	

DC5200 CLOSER PARTS		
PART NO.	DESCRIPTION	LIST PRICE
CLOSER BODY 600, 689, 690, 691, 693, 696		
754F68	Closer Body Only	\$677.00
ARMS 600, 689, 690, 691, 693, 696		
754F95	Slide Track & Arm Assy., Non-Hold Open	\$290.00
754F96	Slide Track & Arm Assy., Hold Open	\$438.00
754F92	Hold Open Assembly	\$70.00
COVER		
754F79	Plastic Cover	\$70.00
DROP PLATE		
754F80	Push side, drop plate	\$75.00
ANGLE BRACKET		
754F93	Slide Track Angle Bracket	\$135.00
SCREW PACKETS		
754F69	Closer Screw Pack	\$18.00
754F70	Spline Screw Pack	\$47.00
754F94	Track Screw Pack	\$23.00
887F32	Torx® Security Screws	\$81.00

CLOSER PARTS

PART NO.	DESCRIPTION	LIST PRICE
CLOSER BODIES 600, 689, 690, 691, 693, 696		
689F12	Closer body for DC6200	\$600.00
689F13	Closer body for DC6200 x M71	\$663.00
689F14	Closer body for DC6401	\$600.00
689F15	Closer body for DC6402	
689F16	Closer body for DC6403	
689F17	Closer body for DC6404	
689F18	Closer body for DC6405	
689F19	Closer body for DC6406	
691F52	Closer body for DC6401 x M71	
691F53	Closer body for DC6402 x M71	
691F54	Closer body for DC6403 x M71	
691F55	Closer body for DC6404 x M71	
691F56	Closer body for DC6405 x M71	
691F57	Closer body for DC6406 x M71	
M71 = Delayed action		
ARMS 600, 689, 690, 691, 693, 696		
688F95	Regular arm, consists of:	\$192.00
	688F99 main arm & tube assembly	\$121.00
	688F98 rod & shoe assembly	\$51.00
	688F92 hex screw pkg.	\$21.00
688F77	Regular arm with hold-open (A1), consists of:	\$284.00
	691F92 main arm & rod assy	\$112.00
	540F40 hold-open bracket assembly	\$172.00
689F02	Heavy duty parallel arm (A3)	\$289.00
689F01	Heavy duty parallel arm with hold-open (A2)	\$323.00
597F52	Heavy duty regular arm (A10)	\$289.00
689F03	Heavy duty parallel arm with backstop (A4)	\$318.00
689F04	Heavy duty parallel arm with backstop & hold-open (A5)	\$380.00
615F52	HD Spring stop for Dr. width. 28"-32" (A11)	\$540.00
615F54	Unitrol® for Dr. width. 33"-41"	
615F56	Unitrol® for Dr. width. 42"-48"	
615F51	Unitrol®/HO for Dr. width. 28"-32" (A12)	
615F53	Unitrol®/HO for Dr. width. 33"-41"	
615F55	Unitrol®/HO for Dr. width. 42"-48"	
691F96	Heavy-duty offset arm (A13)	
754F16	DC6230, DC6430 pull side - arm only	\$147.00
754F10	DC6230, DC6430 - track only (hold-open)	\$438.00
754F09	DC6230, DC6430 - track only (non hold-open)	\$290.00
754F44	DC6230, DC6430 pull side track assembly, non-hold open	\$619.00
754F45	DC6230, DC6430 pull side track assembly, hold open	\$774.00
754F12	DC6240, DC6440 push side track & arm (non hold open)	\$432.00
754F14	DC6240, DC6440 - track only (non hold-open)	\$290.00
754F13	DC6240, DC6440 track & arm (hold-open)	\$586.00
754F15	DC6240, DC6440 - track only (hold-open)	\$438.00
754F16	DC6240, DC6440 - arm only (hold-open)	\$147.00
691F72	Deep reveal arm (7-1/4" max), consists of:	\$185.00
	688F99 main arm and arm tube assy	\$121.00
	691F75 rod & shoe assembly	\$59.00

PART NO.	DESCRIPTION	LIST PRICE
ARMS 600, 689, 690, 691, 693, 696		
691F74	Deep reveal arm w/hold-open (7-1/4" max), consists of:	\$236.00
	691F95 main arm & rod assy- deep reveal	\$64.00
	540F40 hold-open bracket assy.	\$172.00
615F58	Reinforcing bracket	\$59.00
615F59	Deep reveal reinforcing kit	\$77.00
615F60	Flush partition bracket	\$57.00
692F04	Friction, Hold Open Arm RH	\$277.00
692F05	Friction, Hold Open Arm LH	
692F00	Reg. Secondary Arm Assy.	\$71.00
692F01	Top Jamb Secondary Arm Assy.	\$72.00
692F02	Reg. H.D. Secondary Arm Assy.	\$268.00
692F03	Deep Reveal HD. Secondary Arm Assy.	\$463.00
BRACKETS 600, 689, 690, 691, 693, 696		
188F03	Quik-Install™	\$30.00
188F41	Parallel arm	\$39.00
509F49	Parallel arm with hold-open	\$70.00
188F63	Parallel arm for flush transom	
188F62	Parallel arm offset	\$47.00
244F17	Regular arm mortise	\$84.00
447F14	Angle support	\$70.00
499F30	Flush transom	\$44.00
691F78	Spacer	\$9.50
COVERS 600, 689, 690, 691, 693, 696		
597F78	Full cover and insert pkt. (standard)	\$66.00
603F55	Full metal cover RH/LHR	\$75.00
603F57	Full metal cover LH/RHR	
261F95	Cover screw pack	\$9.50
DROP PLATES 600, 689, 690, 691, 693, 696		
188F65	For DC6220 x full cover	\$111.00
	For DC6420 x full cover	
597F58	For DC6210, DC6410, DC6240, DC6440 x full cover	
597F59	For DC6230, DC6240, x full cover	
	For DC6430, DC6440 x full cover	
BLADE STOP SPACER		
597F92	1/2" Spacer block	\$34.00
597F93	5/8" Spacer block	\$57.00
SCREW PACKETS 600, 689, 690, 691, 693, 696		
691F93	Standard Screw Pack	\$21.00
691F94	Standard Screw Pack w/ Sex Nuts	\$33.00
468F34	SNB for 1-3/4" door	\$20.00
691F89	Torx® Screw Pack	\$47.00
691F90	Torx Screw Pack with Sex Nuts	\$53.00
597F24	Torx® tool kit	\$319.00
754F43	Screw pack (push or pull track)	\$30.00
PAINT (PER CAN)		
597F94	Silver Aluminum - 689	\$88.00
597F95	Dark Bronze - 690	
597F96	Light Bronze - 691	
597F97	Satin Brass - 696	

CLOSER PARTS

PART NO.	DESCRIPTION	LIST PRICE
CLOSER BODIES		
754F21	Closer body for DC8200	\$757.00
754F26	Closer body for DC8200 x M71	\$827.00
ARMS		
688F95	Regular arm, consists of:	\$192.00
	688F99 main arm & tube assembly	\$121.00
	688F98 rod & shoe assembly	\$51.00
	688F92 hex screw pkg.	\$21.00
688F77	Regular arm with hold-open (A1), consists of:	\$284.00
	691F92 main arm & rod assy	\$112.00
	540F40 hold open bracket assembly	\$172.00
689F02	Heavy-duty parallel arm (A3)	\$289.00
689F01	Heavy-duty parallel arm with hold-open (A2)	\$323.00
597F52	Heavy-duty regular arm (A10)	\$289.00
689F03	Heavy-duty parallel arm with backstop (A4)	\$318.00
689F04	Heavy-duty parallel arm with backstop & hold-open (A5)	\$380.00
615F52	Unitrol® - Dr. width 28"-32" (A11)	\$540.00
615F54	Unitrol® - Dr. width 33"-41" (A11)	
615F56	Unitrol® - Dr. width 42"-48" (A11)	\$640.00
615F51	Unitrol® w/ Hold Open - Dr. width 28"-32" (A12)	
615F53	Unitrol® w/ Hold Open - Dr. width 33"-41" (A12)	
615F55	Unitrol® w/ Hold Open - Dr. width 42"-48" (A12)	
691F96	Heavy-duty offset arm (A13)	\$275.00
692F04	Heavy duty friction hold open, RH (A14)	\$277.00
692F05	Heavy duty friction hold open, LH (A14)	\$277.00
754F09	Pull side track only, non-hold open	\$290.00
754F10	Pull side track only, hold open	\$438.00
754F12	Push side track & arm, non-hold open	\$432.00
754F13	Push side track & arm, hold open	\$586.00
754F14	Push side track only, non-hold open	\$290.00
754F15	Push side track only, hold open	\$438.00
754F16	Slide track assembly (non-hold open or hold open)	\$147.00
691F72	Deep reveal arm (7 1/4" max) consists of:	\$185.00
	688F99 main arm and arm tube assy	\$121.00
	691F75 rod & shoe assembly	\$59.00
691F74	Deep reveal arm with hold-open (7 1/4" max), consists of:	\$236.00
	691F95 main arm & rod assy- deep reveal	\$64.00
	540F40 hold open bracket assy.	\$172.00
615F58	Reinforcing bracket	\$59.00
615F59	Deep reveal reinforcing kit	\$77.00
615F60	Flush partition bracket	\$57.00

PART NO.	DESCRIPTION	LIST PRICE
BRACKET		
754F18	Quik-Install™	\$33.00
188F41	Parallel arm	\$39.00
509F49	Parallel arm with hold-open	\$70.00
188F63	Parallel arm for flush transom	
188F62	Parallel arm offset	\$47.00
244F17	Regular arm mortise	\$84.00
447F14	Angle support	\$70.00
499F30	Heavy duty parallel arm flush transom bracket	\$44.00
COVERS		
754F84	Full ABS cover	\$44.00
754F22	Full metal cover RH/LHR	\$103.00
754F23	Full metal cover LH/RHR	
754F17	Cover screw pack	\$9.50
DROP PLATES		
754F20	For DC8200 (regular)	\$135.00
754F24	For DC8200 (with concealed holder)	\$135.00
	For DC8220 (top jamb)	
754F25	For DC8210 (parallel)	\$135.00
	For DC8230 (pull side track)	
	For DC8240 (push side track)	
BLADE STOP SPACER		
597F92	1/2" Spacer block	\$34.00
597F93	5/8" Spacer block	\$57.00
SCREW PACKETS		
754F37	Standard screw pack	\$22.00
754F29	Standard screw pack (includes sex nuts)	
754F30	SNB for 1-3/4" door	\$28.00
754F38	Torx® screw pack	\$69.00
754F34	Torx screw pack (includes sex nuts)	
597F24	Torx® tool kit	\$319.00
754F35	Main arm screw & washer	\$12.00
RETROFIT PLATES		
754F36	To Replace DC6000 (Reg. Arm)	\$151.00
754F46	To Replace DC6000 (Par. Arm or Top Jamb)	\$151.00

PART NO.	DESCRIPTION	LIST PRICE
DC62900 SERIES ELECTROMECHANICAL CLOSERS		
689F12	DC6000 Closer Body	\$600.00
188F03	Quik-Install Bracket	\$30.00
597F78	Full Cover	\$66.00
603F55	Full Metal Cover RH	\$75.00
603F57	Full Metal Cover LH	
692F24	Standard Arm Assembly	\$148.00
692F25	Adjusting Head and Tube Assembly	\$187.00
692F14	Slide Assembly	\$161.00
692F15	Arm Stud Clip	\$17.00
692F16	Track Assembly End Cap	\$13.00
692F17	Solenoid Block Assembly, 24V	\$517.00
692F19	Adjusting Rod Assembly	\$77.00
692F20	Arm Stud	\$12.00
692F21	Retaining Ring	\$6.30
692F23	Arm Length Adjusting Screw	\$4.70
754F02	Double Egress Arm, RH	\$271.00
754F03	Double Egress Arm, LH	
754F04	Adjusting Head and Tube Assembly, RH	\$185.00
754F05	Adjusting Head and Tube Assembly, LH	
754F52	Track Assy. (Hinge Side) support units	\$640.00
754F53	Track Assy. (Stop Side) support units	
754F54	Hook-Up Board, Support, 24V	\$209.00
754F55	Hook-Up Board, Support, 120V	\$314.00
754F58	Hook-Up Box, Support unit, 24V, push side	\$538.00
754F59	Hook-Up Box, Support unit, 120V, push side	
754F63	Hook-Up Box, Support unit, 24V, pull side	\$555.00
754F64	Hook-Up Box, Support unit, 120V, pull side	
754F66	Fuse	\$32.00
754F72	Hook-Up Box Cover Kit (included cover & screws), Support	\$89.00

PART NO.	DESCRIPTION	LIST PRICE
Access 800® AC2 Series		
794F509	Gaskets Exit device - Reader	\$18.00
794F519	Gaskets Exit device trim	
794F529	Gaskets Cylindrical lock	\$23.00
794F539	Gaskets Mortise lock	

PART NO.	DESCRIPTION	LIST PRICE
Motorized		
789F929	ECOFLEX, Motor SUB Assembly	\$218.00
728F709	Harness Fail Safe / Fail Secure	\$27.00
789F859	Motor Mortise ECOFLEX	\$177.00
728F759	ECOFLEX ET Harness A800 AC2	\$27.00
789F869	ECOFLEX ET Link Harness IN100	
728F799	ECOFLEX ET Link Harness A800 WI1 & IP1	
789F879	ECOFLEX ET Link Harness A700 PIP1, PWI1, IN120, IN220	
728F809	ECOFLEX ET Link Harness A700 PAC1	
728F939	ECOFLEX ET Link Harness A600 & SE LP10	
728F799	ECOFLEX ET Ground Wire A800 WI1, IP1	

Part Number	Page	Part Number	Page	Part Number	Page	Part Number	Page	Part Number	Page
019F137	411	122F618	420	183F857	419	217L13M022	400	221F948*	421
021F688	378	122F639	420	184F825	420	217L13M022	404	222F71*	421
021F718	378	122F643*	420	184F948	420	217L13M022	406	222F85	412
022F723	412	123F22	419	186F748	378	217L13M022	409	223F29	412
022F80	411	123F538	420	188F03	424	217L13M022	410	224F008	409
025F722	378	129F499	420	188F03	425	217L13M024	400	224F348	421
025F858	406	129F848	378	188F03	427	217L13M024	404	224F392	421
025F858	408	129F848	420	188F41	424	217L13M024	406	224F448	421
026F757	377	131F278	411	188F41	425	217L13M024	409	224F508	421
041F478	378	134F05	379	188F41	426	217L13M024	410	225F998	421
041F478	400	134F05	420	188F62	424	217L13M028	400	228F188	421
060F053	412	135F108	378	188F62	425	217L13M028	404	228F348	412
060F338	411	135F192	378	188F62	426	217L13M028	406	228F497	421
060F428	411	138F888	411	188F63	424	217L13M028	409	228F517	421
067F428	411	140F528	420	188F63	425	217L13M028	410	228F528	421
070F428	411	140F978	411	188F63	426	217L13M032	400	228F558	421
070F438	411	141L548	420	188F65	424	217L13M032	404	228F687	421
071F628	411	141L59	420	188F65	425	217L13M032	406	228F808	421
071F638	411	142F43	419	188F738	412	217L13M032	409	228F817	421
071F673	412	142F44*	420	188F758	412	217L13M032	410	228F847	421
077F198	423	143F248	420	194F228	411	217L13M036	400	236L720M40FIN	382
078F078	411	144F298	412	195K68	376	217L13M036	404	236L720M44FIN	382
079F00	381	144F308	412	197F347	378	217L13M036	406	236L720M48FIN	382
079F02	381	144F33	411	197F357	378	217L13M036	409	236L72M014FIN	382
081F778	411	144F34	411	197F527	377	217L13M036	410	236L72M018FIN	382
082L67	412	144F888	412	198F71	411	217L13M040	400	236L72M020FIN	382
083L96M032	412	145F328	412	200F168	421	217L13M040	404	236L72M022FIN	382
083L96M034	412	145F543*	420	201F188	412	217L13M040	406	236L72M024FIN	382
083L96M036	412	146F788	378	206F578	395	217L13M040	409	236L72M028FIN	382
083L96M040	412	147F078	411	213F117	421	217L13M040	410	236L72M032FIN	382
083L96M048	412	148F228	423	217F422	377	217L13M044	400	236L72M036FIN	382
092F789	412	148F367	420	217F43	378	217L13M044	404	236L75M020	412
102F198	412	148F448	420	217F432	377	217L13M044	406	240L08018	412
102F278	412	156F43	411	217F44	378	217L13M044	409	240L08020	412
102F378	412	156F648	412	217F442	377	217L13M044	410	240L08022	412
103F448	412	156F658	412	217L13M016	400	217L13M048	400	240L50	419
103F458	412	156F837	411	217L13M016	404	217L13M048	404	240L51	419
114F678	412	157F11	411	217L13M016	406	217L13M048	406	242F508	412
118F299	418	158F062	378	217L13M016	409	217L13M048	409	243F769	421
120F768	400	164F329	420	217L13M016	410	217L13M048	410	243F798	421
121F012	378	168F818	412	217L13M018	400	219F888	378	243F808	421
122F188	420	171F468	377	217L13M018	404	220F498	421	243F85	421
122F248	420	171F798	411	217L13M018	406	220F718	395	244F17	424
122F413	420	173F698	420	217L13M018	409	220F722	421	244F17	425
122F508	420	173F728	420	217L13M018	410	220F75	421	244F17	426
122F518	420	173F798	378	217L13M020	400	220F75-B	421	244F647	412
122F568	420	175F518	420	217L13M020	404	220F778	421	249F33*	421
122F578	420	176F653	419	217L13M020	406	220F827	421	249F768	412
122F593	420	183F74	420	217L13M020	409	220F848	421	249F773	412
122F608	420	183F75	420	217L13M020	410	220F85*	421	250F088	378

Part Number	Page	Part Number	Page	Part Number	Page	Part Number	Page	Part Number	Page
251F198	412	269F569	421	333F519	422	351F988	422	393L13-M672*	423
252F82	379	269F578	421	333F998	378	352F021	422	393L13-M672*	423
253F118	421	269F587	421	334F128	378	352F042	419	394F198	412
253F758	378	269F608	421	334F238	378	352F05	419	399F178	423
253F768	378	269F73	419	334F99	423	352F068	422	399F188	423
253F778	378	269F74	419	334F998	381	353F868	378	402F29	381
253F858	378	269F75	419	334K01	376	354F198	378	402F30	381
253F97	379	269F76	419	335F988	412	361F308	422	402F31	381
254F73	421	269F808	395	340L60M018FIN	383	361F913	419	402F33	381
255F41*	421	269F91*	421	340L60M020FIN	383	362F153	378	402F34	381
255F53	379	269F92*	421	340L60M022FIN	383	362F432	378	402F35	381
255F54	380	270F01*	421	340L60M024FIN	383	362F498	422	402F738	381
261F118	412	270F02*	421	340L60M028FIN	383	362F918	422	402F983	423
261F288	421	270F11*	421	340L60M032FIN	383	364F228	422	402F99*	423
261F298	412	270F15	379	340L60M036FIN	383	364F272	422	402F99*	423
261F318	421	281F272	378	340L60M040FIN	383	364F288	422	403F035	423
261F54	421	282F325	421	340L60M044FIN	383	364F308	422	403F30*	423
261F658	421	282F357	421	340L60M048FIN	383	364F36*	422	403F302 Fin	395
261F95	425	283F81	412	340L617020FIN	383	364F37*	422	403F568	382
262F901	421	284F138	378	340L61M018FIN	383	364F38*	422	403F677	381
264F698	387	284F67*	421	340L61M022FIN	383	364F39*	422	404F858	382
264F958	421	284F977	422	340L61M024FIN	383	365F003	422	404F868	381
267F97	379	286F507	411	340L61M028FIN	383	365F013	422	405F428	423
268F647	421	287F608	412	340L61M032FIN	383	365F033	422	405F458	423
268F848	421	291F498	422	340L61M036FIN	383	365F958	378	405F476	423
268F878	421	291F578	422	340L61M040FIN	383	365F968	378	405F496	423
269F048	421	293F183	422	340L61M044FIN	383	365F98*	422	405F772	412
269F058	421	293L14	412	340L61M048FIN	383	366F70	380	406F438	378
269F08	421	300F688	391	341F318	422	368F918	378	407K63	376
269F088	381	300F71	419	342F032	412	370F29	379	407K64	376
269F098	390	301F567	411	342F052	411	370F31	379	407K65	376
269F31	421	303F242	412	351F50*	422	370F33	380	407T314097	377
269F32	421	303F25	379	351F51*	422	370F35	380	407T314125	377
269F33	421	304F337	419	351F528	422	376F37*	423	407T314153	377
269F34	421	304F347	419	351F553	422	376F42	422	407T324097	377
269F35	421	305F318 Fin	395	351F56*	422	377F308	388	407T324125	377
269F36	421	306F068	422	351F57*	422	377F80	386	407T324153	377
269F378	421	306F078	422	351F72	422	378K18	376	407T334097	377
269F393	421	314F887	377	351F73	422	379F805	378	407T334125	377
269F403	421	314F987	377	351F797	422	381F30	411	407T334153	377
269F413	421	314F997	378	351F807	422	383F82	386	407T414242	377
269F42	421	315F93 Fin	404	351F823	422	384F03	390	407T414270	377
269F468	421	315F94 Fin	404	351F833	422	384F11	386	407T414298	377
269F479	421	318F66	383	351F849	422	391F658	380	407T414326	377
269F488	421	320F442	378	351F85*	422	391F658	388	407T414354	377
269F499	421	320F442	412	351F867	422	392F22	419	407T424242	377
269F528	421	321F24*	423	351F873	422	392F24	419	407T424270	377
269F538	421	321F907	422	351F883	422	392F28	419	407T424298	377
269F549	421	329F998	378	351F897	422	392F29	419	407T424326	377
269F559	421	330F10	424	351F907*	422	392L19*	423	407T424354	377

Part Number	Page	Part Number	Page	Part Number	Page	Part Number	Page	Part Number	Page
407T434158	377	427F43	385	446F582	378	468F212*	423	487K17	376
407T434193	377	427F45	385	446K68	376	468F246	423	487K19	376
408F258	423	427F47	385	447F14	424	468F256	423	487K21	376
408K45	376	428F32	384	447F14	425	468F266	423	487K38	376
409F865	402	428F33	384	447F14	426	468F276	423	487M048589	419
409F875	403	428F34	384	447F24	390	468F34	425	488F00	387
409F875	408	428F66	379	447F25	390	468F355	423	488F01	387
409F905	408	429F317	390	447F41	379	480F128	423	488F03	386
409K12	376	429F41	382	447F42	379	480F13*	423	488F04	386
411L62	419	429F41	415	447F43	379	480F188	423	488F05	386
411L62M016FIN	383	432F86	391	447F43	415	480F198	423	488F07	386
411L62M018FIN	383	433F76	391	447F44	380	480F208	423	488F088	378
411L62M020FIN	383	433F77	391	447F45	380	480F28*	423	488F088	384
411L63	419	433F78	391	447F46	380	480F30*	423	488F09	382
411L63M016FIN	383	433F978	423	461F108	378	480F33*	423	488F108	378
411L63M018FIN	383	433F988	423	463F918	419	480F375	423	488F108	384
411L63M020FIN	383	434F008	423	464F028	423	480F68	409	488F27	384
412F133*	423	434F028	423	464F915	423	480F688 Fin	404	488F31	384
412F157	423	436F038	419	465F57	382	480F69	412	488F928	378
412F167	423	436F177	382	466F229	382	480F70	412	488K84	376
412F451	423	437F26	384	466F279	412	480F708	412	488K85	376
413F488	378	437F28	384	466F40	384	482F37	384	488K99	376
413F498	378	437F40	384	466F41	384	482F442	423	489F028	378
415F16	411	437F41	384	466F42	384	482F49*	423	489F882	411
415K73	376	437F42	384	466F45	384	482F73*	423	489F892	411
415K74	376	438F37	384	466F46	384	483F118	388	489K49	376
416F355	419	438F38	384	466F47	384	483F30	384	490F558	378
416F38	412	438F418	378	466F50	384	483F34	384	492F195	423
416F39	379	438F428	378	466F51	384	483F35	384	492K90	376
416F818	423	438F90	387	466F52	384	483F36	384	492K91	376
416K08	376	439F25	384	466F73	384	483F79	390	492K92	376
418F288	423	439F26	384	466F74	384	483F80	390	493F31	390
418F308	423	439F27	384	466F75	384	483F81	390	493F34	390
418F352	423	439F33	391	467F338	412	483F82	390	493F76	376
418F368	423	439F34	391	467F345	412	483F83	390	493F77	376
418F378	423	439F35	391	467F358	412	483F84	390	493F78	376
420F128*	423	442F952	411	467F36	412	483K01	376	496F32	411
422F88	379	444F748	378	467F378	412	484F418	423	496F33	411
422L842144	412	444F758	378	467F733	419	484F898	423	496F34	411
422L848144	412	444K96	376	467F942	423	484F918	378	496F718	412
423F54	381	444K97	376	467F952*	423	484F928	378	497F528	390
423F55	381	444K98	376	468F022*	423	484F938	378	498F928	391
423F57	381	444K99	376	468F032*	423	484F948	378	499F30	425
423F58	381	445F318	391	468F122	423	484F958	378	499F30	426
423L71	412	445F82	390	468F132	423	484F968	378	499F598	419
424F838	412	445F83	390	468F147	423	487F08	390	499F608*	422
426F52	385	445F84	390	468F157	423	487K10	376	499F828	390
427F06	384	445F85	391	468F162	423	487K11	376	499F838	390
427F078	384	445F869	390	468F172	423	487K13	376	499F848	390
427F39	385	446F572	378	468F202*	423	487K15	376	502F75	419

Part Number	Page	Part Number	Page	Part Number	Page	Part Number	Page	Part Number	Page
502F96	419	544F95	386	582F122	411	586L19M020	410	597F24	426
503F52	419	544F96	386	582F132	411	586L19M022	400	597F35	424
503F533	419	544F97	386	582F142	411	586L19M022	404	597F52	424
503F533	423	544F98	386	582F298	378	586L19M022	409	597F52	425
503F557	423	544F99	386	584F46	390	586L19M022	410	597F52	426
503F567	423	545F00	386	585F312	378	586L19M024	400	597F58	424
506F57	380	545F42	386	585F327	377	586L19M024	404	597F58	425
509F49	424	545F43	386	585F337	378	586L19M024	409	597F59	425
509F49	425	545F44	386	585F358	378	586L19M024	410	597F78	424
509F49	426	545F45	386	585F367	378	586L19M028	400	597F78	425
511F51	384	545F79	385	585F377	378	586L19M028	404	597F78	427
511F52	384	545F80	385	585F387	378	586L19M028	409	597F92	425
518K73	376	545F81	385	585F397	377	586L19M028	410	597F92	426
518K74	376	545F82	385	585F407	378	586L19M032	400	597F93	425
518K75	376	545F83	385	585F705	402	586L19M032	404	597F93	426
518K76	376	545F84	385	585F715	402	586L19M032	409	597F94	424
518K77	376	545F85	385	585F729	401	586L19M032	410	597F94	425
519F09	391	545F86	385	585F76 Fin	404	586L19M036	400	597F95	424
519F10	391	545F87	385	585F762	405	586L19M036	404	597F95	425
519F11	391	545F88	385	585F762	407	586L19M036	409	597F96	424
519F12	391	546F978	377	585F77 Fin	404	586L19M036	410	597F96	425
520F358	378	549F352	411	585F772	405	586L19M040	400	597F97	424
522F932	378	549F362	411	585F772	407	586L19M040	404	597F97	425
534K25	376	549F52	379	585F78 Fin	404	586L19M040	409	598F20	401
540F27	424	553F482 x length	377	585F79 Fin	404	586L19M040	410	598F21	401
540F625	402	553F492 x length	377	585K46	376	586L19M044	400	598F22	401
540F685	403	553F502 x length	377	586F16	401	586L19M044	404	598F59 Fin	400
544F13	387	556F558	409	586F17	401	586L19M044	409	598F59 Fin	404
544F14	387	557F29	386	586F18	401	586L19M044	410	598F592	406
544F38	387	561F29	423	586F51 Fin	404	586L19M048	400	598F592	408
544F39	387	562F402	378	586F512	408	586L19M048	404	598F809	406
544F40	387	562F422	378	586F80	401	586L19M048	409	598F809	408
544F41	387	563F885	402	586F81	401	586L19M048	410	598F815	406
544F42	387	563F895	402	586F82	401	592F338	415	598F815	408
544F43	386	563F905	402	586F86	401	596F618	409	598F825	406
544F44	387	563F945	402	586F87	401	596F618 Fin	404	598F825	408
544F45	387	563F955	402	586F88	401	596F628	409	598F835	406
544F46	386	563F965	402	586L19	394	596F628 Fin	404	598F835	408
544F76	385	564K53	376	586L19	408	596F66	401	598F905	406
544F77	385	564K59	376	586L19M016	400	596F67	401	598F905	408
544F79	385	564K60	376	586L19M016	404	596F68	401	599F275	406
544F80	385	566F50	418	586L19M016	409	596F825	402	599F275	408
544F85	385	566F51	418	586L19M016	410	596F879	378	599F389	378
544F87	385	569F45	390	586L19M018	400	596F898	378	599F91	400
544F88	385	574F158	380	586L19M018	404	596K29	376	599F91	405
544F89	385	578F435	402	586L19M018	409	596K30	376	599F91	407
544F91	385	579F11	410	586L19M018	410	596K31	376	599F92	400
544F92	385	580K99	376	586L19M020	400	596K32	376	599F92	405
544F93	385	581F96	391	586L19M020	404	597F24	424	599F92	407
544F94	386	582F112	411	586L19M020	409	597F24	425	599F93	405

Part Number	Page	Part Number	Page	Part Number	Page	Part Number	Page	Part Number	Page
599F93	407	600F425	402	604F268	406	613F132	411	624F53	381
599F94	400	600F62	405	604F268	408	613F142	411	627F009	397
599F94	405	600F62	407	604F268	409	613F152	411	628F107142	377
599F94	407	600F63	405	604F268 Fin	400	613F162	411	628F107171	377
599F95	400	600F63	407	604F268 Fin	404	613F172	411	628F107236	377
599F95	405	600F64	405	604F278	409	613F222	411	628F825	378
599F95	407	600F64	407	604F278 Fin	400	613F232	411	628F835	378
599F96	405	600F65	405	604F278 Fin	404	613F242	411	628F892	377
599F96	407	600F65	407	604F288	409	613F252	411	628F912	377
599F97	400	600F66	405	604F288 Fin	400	613F352	411	628F922 x Fin	377
599F97	405	600F66	407	604F288 Fin	404	613F422	411	628F932	378
599F97	407	600F67	405	605F42	384	613F432	411	628F962	377
599F98	400	600F67	407	605F43	379	615F51	425	628K852 x Fin	376
599F98	405	600F68	405	605F768	412	615F51	426	628K872 x Fin	376
599F98	407	600F68	407	605F778	412	615F52	425	628K882 x Fin	376
599F99	405	600F69	405	605F90	411	615F52	426	628K902 x Fin	376
599F99	407	600F69	407	606F018	412	615F53	425	628K952 x Fin	376
600F00	400	600F70	405	606F028	412	615F53	426	628K972 x Fin	376
600F00	405	600F70	407	606F038	411	615F54	425	628K992 x Fin	376
600F00	407	600F71	405	606K73	376	615F54	426	629F062 x Fin	377
600F01	400	600F71	407	606K74	376	615F55	425	629F072 x Fin	377
600F01	405	600F72	405	606K75	376	615F55	426	629K002 x Fin	376
600F01	407	600F72	407	606K76	376	615F56	425	629K012 x Fin	376
600F02	405	600F73	405	606K77	376	615F56	426	629K022 x Fin	376
600F02	407	600F73	407	606K78	376	615F58	425	629K032 x Fin	376
600F03	405	601F229	378	606K79	376	615F58	426	629K042 x Fin	376
600F03	407	601F24	401	607F76	400	615F59	425	630F482 x Fin	377
600F04	405	601F25	401	607F919	378	615F59	426	630F494	377
600F04	407	601F26	401	609F36	379	615F60	425	630K472 x Fin	376
600F05	405	601F283 Fin	404	609F36	415	615F60	426	631F248	378
600F05	407	601F69	400	609F37	379	616F078	390	631F248	401
600F06	405	601F69	401	609F37	415	616F088	390	631F248	405
600F06	407	602F198	381	609F38	379	616F12	382	631F248	407
600F07	405	603F207	377	610F01	379	616F208	378	631F288	394
600F07	407	603F55	425	610F01	415	616F218	378	649F99 fin	414
600F08	405	603F55	427	610F02	379	622F298	378	650F00	414
600F08	407	603F57	425	610F49	376	622F308	378	650F03	414
600F09	405	603F57	427	610K46	376	622F308	401	650F04	414
600F09	407	604F228	406	610K48	376	622F308	405	650F05	414
600F10	405	604F228	408	610L43	412	622F308	407	650F06	414
600F10	407	604F228	409	610L44	412	622F328	378	650F07	414
600F11	405	604F228 Fin	395	612K88	376	622F328	378	650F08	414
600F11	407	604F228 Fin	400	612K90	376	622F698	378	650F095	416
600F12	405	604F228 Fin	404	612K91	376	624F427	382	650F11	414
600F12	407	604F238	409	612K93	376	624F439	382	650F12	414
600F13	405	604F238 Fin	400	612K94	376	624F449	382	650F13	414
600F13	407	604F238 Fin	404	613F029	411	624F455	382	650F14	414
600F14	405	604F248	409	613F102	411	624F478	382	650F15	414
600F14	407	604F248 Fin	400	613F112	411	624F488	381	650F16	414
600F415	402	604F248 Fin	404	613F122	411	624F49	381	650F189	414

Part Number	Page	Part Number	Page	Part Number	Page	Part Number	Page	Part Number	Page
650F21	414	650F959	415	651F965	418	652F77	417	653F61	416
650F228	414	650F968	414	651F988	418	652F78	416	653F61	417
650F238	414	650F978	415	652F048	418	652F79	416	653F62	416
650F248	414	650F998	414	652F058	418	652F79	417	653F62	417
650F279	415	650L65	415	652F068	418	652F80	416	653F63	416
650F288	415	650L657020	415	652F098	418	652F80	417	653F63	417
650F318	415	651F00	417	652F108	418	652F81	416	653F65	416
650F358	414	651F01	417	652F118	418	652F82	416	653F65	417
650F368	414	651F04	417	652F128	418	652F82	417	653F66	416
650F378	414	651F06	417	652F138	418	652F83	416	653F66	417
650F388	414	651F08	417	652F148	418	652F83	417	653F68	416
650F398	414	651F09	417	652F158	418	652F84	416	653F68	417
650F408	414	651F10	417	652F218	418	652F85	416	653F69	416
650F418	414	651F362	418	652F228	418	652F86	416	653F69	417
650F428	414	651F372	418	652F239	418	652F87	416	653F70	416
650F438	414	651F389	418	652F298	415	652F88	416	653F70	417
650F448	414	651F398	418	652F57	416	652F89	416	653F71	416
650F458	414	651F408	418	652F58	416	652F90	416	653F71	417
650F468	414	651F418	418	652F58	417	652F92	416	653F72	416
650F489	416	651F425	418	652F59	416	652F92	416	653F72	417
650F498	416	651F448	418	652F59	417	652F93	416	653F73	416
650F508	415	651F478	418	652F60	416	652F95	416	653F73	417
650F518	415	651F498	418	652F61	416	652F96	416	653F74	416
650F528	414	651F508	418	652F61	417	652F99	416	653F74	417
650F538	415	651F538	418	652F62	416	653F02	416	653F75	416
650F548	416	651F545	418	652F62	417	653F03	416	653F75	417
650F558	416	651F568	418	652F63	416	653F04	416	653F76	416
650F568	416	651F578	418	652F64	416	653F05	416	653F76	417
650F578	415	651F587	418	652F64	417	653F08	416	653L157014	415
650F588	414	651F608	418	652F65	416	653F09	416	653L163016	415
650F598	414	651F618	418	652F65	417	653F10	416	653L163020	415
650F60 fin	416	651F628	418	652F66	416	653F12	414	653L183016	415
650F62	415	651F638	418	652F67	416	653F13	414	653L183020	415
650F63	415	651F648	418	652F67	417	653F14	414	654F07	379
650F64	414	651F655	418	652F68	416	653F50	416	654F08	379
650F678LR	415	651F675	418	652F68	417	653F50	417	654F208	415
650F678RR	415	651F708	418	652F69	416	653F53	416	654F218	415
650F698LR	415	651F738	418	652F70	416	653F53	417	655F028	418
650F698RR	415	651F758	418	652F70	417	653F54	416	655F15	415
650F718	416	651F828	418	652F71	416	653F54	417	655F16	415
650F728	416	651F838	418	652F71	417	653F55	416	655F17	415
650F738	416	651F848	418	652F72	416	653F55	417	655F488LR	415
650F778	414	651F858	418	652F73	416	653F56	416	655F488RR	415
650F798	414	651F868	418	652F73	417	653F56	417	655F548	418
650F808	416	651F878	418	652F74	416	653F57	416	655F698	418
650F818	416	651F888	418	652F74	417	653F57	417	655F708	418
650F828	415	651F898	418	652F75	416	653F59	416	655F718	415
650F878	415	651F928	418	652F76	416	653F59	417	656F408	415
650F888	415	651F938	418	652F76	417	653F60	416	656F41	415
650F93	414	651F948	418	652F77	416	653F60	417	656F53	416

Part Number	Page	Part Number	Page	Part Number	Page	Part Number	Page	Part Number	Page
656F58	417	677F14	417	682F018	382	684F805	403	689F12	427
656F59	417	677F15	417	682F298	378	684F805	408	689F13	425
656F60	417	677F16	417	682F298	401	684F815	403	689F14	425
656F61	417	677F26	417	682F298	405	684F815	408	689F15	425
656F62	417	677F27	417	682F298	407	684F825	403	689F16	425
656F63	417	677F28	417	682F398	378	684F825	408	689F17	425
656F64	418	677F42	376	682F398	401	684F835	403	689F18	425
656F658	418	677F768LR 626	418	682F398	405	684F835	408	689F19	425
656F668	415	677F768RR 626	418	682F398	407	684F845	403	690F975	402
670F30	389	677F778LR 626	418	682F608	404	684F845	408	690F985	403
670F31	389	677F778RR 626	418	682F618	404	684F855	403	690F985	408
670F32	389	678F008LR	415	682F628	404	684F855	408	691F52	425
670F33	389	678F008RR	415	682F638	404	684F865	403	691F53	425
670F34	389	678F028	418	682F64 Fin	404	684F865	408	691F54	425
670F35	389	678F248	404	682F65 Fin	404	684F875	408	691F55	425
670F36	389	678F248	406	682F67 Fin	404	684F885	403	691F56	425
670F37	389	678F248	408	682F68 Fin	404	684F885	408	691F57	425
670F38	389	678F25 Fin	400	682F788	404	685F098	378	691F72	425
670F57	389	678F25 Fin	404	682F788	406	685F387	382	691F72	426
670F58	389	678F252	406	682F788	408	685F875	403	691F74	425
670F59	389	678F252	408	682F86 Fin	404	686F858	401	691F74	426
670F60	389	678F252 Fin	393	682F87 Fin	404	686F858	405	691F78	425
670F61	389	678F498	404	682F958	401	686F858	407	691F89	425
670F62	389	678F498	408	682F958	405	686F868	401	691F90	425
670F63	389	678F548	381	682F958	407	686F868	405	691F93	425
670F64	389	678F677	381	682F969	401	686F868	407	691F94	425
670F65	389	679F818	395	682F969	405	686F88 Fin	404	691F96	425
670F66	389	679F818	401	682F969	407	686F882	408	691F96	426
670F67	389	679F818	411	684F055	382	688F017	382	691F98	424
670F68	389	680F348	391	684F067	382	688F77	424	691F99	424
670F69	389	680F358	391	684F119	382	688F77	424	692F00	425
670F70	389	680F368	391	684F129	382	688F77	425	692F01	425
670F71	389	680F645	378	684F42	415	688F77	426	692F02	424
670F72	389	680L50	408	684F427	415	688F95	424	692F02	425
670F73	389	680L50	410	684F44 Fin	404	688F95	424	692F03	424
670F74	389	680L51	408	684F448	406	688F95	425	692F03	425
671F02	389	680L52	408	684F448	408	688F95	426	692F04	425
671F03	389	681F30	381	684F45 Fin	404	689F01	424	692F04	426
671F04	389	681F31	381	684F46 Fin	404	689F01	425	692F05	425
671F05	389	681F40	381	684F528	404	689F01	426	692F05	426
671F06	389	681F41	381	684F528	406	689F02	424	692F14	427
671F07	389	681F448	382	684F528	408	689F02	425	692F15	427
671F08	389	681F608	414	684F539	408	689F02	426	692F16	427
671F09	389	681F618	414	684F559	381	689F03	424	692F17	427
671F10	389	681F62	414	684F775	403	689F03	425	692F19	427
677F04	417	681F63	414	684F775	408	689F03	426	692F20	427
677F05	417	681F708	416	684F785	403	689F04	424	692F21	427
677F068	418	681F718	416	684F785	408	689F04	425	692F23	427
677F098	418	681F768	416	684F795	403	689F04	426	692F24	427
677F13	417	681F778	416	684F795	408	689F12	425	692F25	427

Part Number	Page	Part Number	Page	Part Number	Page	Part Number	Page	Part Number	Page
692F632	392	695F257110 - .110"	377	700F46	387	706F15	414	712F535	402
692F642	392	695F257126 - .126"	377	700F47	387	706F16	414	712F545	402
692F652	392	695F257141 - .141"	377	700F575	378	706F462	415	712F555	402
692F662	392	695F257157 - .157"	377	700F65	391	706F70	391	712F565	402
692F672	392	696F39	391	700F66	391	707F299	397	712F575	402
692F752	392	696F42	378	700F67	391	707F57	391	712F605	403
692F762	392	696F472	377	700F708	382	707F58	391	712F615	403
692F862	392	696F499	377	700F748	382	707F59	391	712F625	403
692F932	392	696F502 x Fin	377	700F80	387	707F60	391	712F635	403
692F942	392	696F51	378	700F81	387	710F00M	415	712F645	403
692F952	392	696K43	376	700F82	387	710F318LR	415	712F655	403
693F208	412	696K45	376	700F83	387	710F318RR	415	712F665	403
694F312	392	696K46	376	700F84	387	710F328LR	415	712F675	403
694F322	392	696K48	376	700F86	387	710F328RR	415	712F685	402
694F332	392	696K52	376	700F87	387	710F338LR	415	712F695	402
694F352	392	697F338	415	700F907	381	710F338RR	415	712F705	402
694F392	392	697F348	415	700F957	382	710F618	404	712F715	402
694F442	392	697F358	415	701F228	381	710F628	404	712F725	402
694F482	392	697F368	415	701F60	415	710F658	404	712F735	402
694F522	392	697F50	378	701F61	415	710F668	404	712F745	403
694F562	392	697F507	377	701F62	415	711F002	391	712F755	403
694F682	392	697F862	414	701F63	415	712F205	402	712F765	403
694F802	392	697F942	401	701F705	382	712F215	402	712F775	403
695F042 x Fin	377	697F942	405	701F748	381	712F225	402	712F785	403
695F052 x Fin	377	697F942	407	702F987	381	712F235	402	712F795	403
695F075	402	697F995	403	703F997	382	712F265	402	713F518	415
695F244139 - .139"	377	698F038	414	704F269	414	712F275	402	713F528	415
695F244155 - .155"	377	698F22	390	704F279	414	712F305	403	713F908	415
695F244171 - .171"	377	698F31	417	704F479	414	712F315	403	713F938	415
695F244187 - .187"	377	698F32	417	704F489	414	712F325	403	713F948	415
695F244202 - .202"	377	698F33	417	704F569	414	712F335	403	713F958	415
695F247139 - .139"	377	698F34	417	704F579	414	712F345	403	713F988	415
695F247155 - .155"	377	698F64	417	704F589	414	712F355	403	713F998	415
695F247171 - .171"	377	698F65	417	704F599	414	712F365	403	714F005	402
695F247187 - .187"	377	698F66	417	704F62	415	712F375	403	714F035	402
695F247202 - .202"	377	698F67	417	704F63	415	712F385	402	714F065	402
695F252031 - .031"	377	698F68	417	704F648	415	712F395	402	714F125	402
695F252047 - .047"	377	698F69	417	704F658	415	712F405	402	714F155	403
695F252063 - .063"	377	698F70	417	704F66	415	712F415	402	714F185	403
695F252078 - .078"	377	698F71	417	705F949	381	712F425	402	714F215	403
695F252094 - .094"	377	700F168	391	706F005	418	712F435	402	714F255	402
695F252110 - .110"	377	700F278	381	706F015	418	712F445	403	714F275	403
695F252126 - .126"	377	700F367	391	706F038	414	712F455	403	714F305	402
695F252141 - .141"	377	700F378	391	706F048	414	712F465	403	714F315	402
695F252157 - .157"	377	700F40	387	706F058	414	712F475	403	714F365	402
695F257031 - .031"	377	700F41	387	706F068	414	712F485	403	714F375	402
695F257047 - .047"	377	700F42	387	706F078	414	712F495	403	714F425	402
695F257063 - .063"	377	700F43	387	706F088	414	712F505	402	714F455	402
695F257078 - .078"	377	700F44	387	706F098	414	712F515	402	714F485	403
695F257094 - .094"	377	700F45	387	706F108	414	712F525	402	714F495	403

Part Number	Page	Part Number	Page	Part Number	Page	Part Number	Page	Part Number	Page
714F545	403	733F50	417	754F37	426	763F002303	377	776F415	393
714F555	403	733F51	417	754F38	426	763F002333	377	776F425	393
714F605	403	733F52	417	754F43	425	763F002363	377	776F515	393
714F635	403	733F53	417	754F44	425	763F002393	377	776F525	393
715F108	378	741F21	391	754F45	425	763F012030	377	776F575	393
715F118	378	741F22	391	754F46	426	763F012060	377	776F585	393
715F128	378	741F23	391	754F52	427	763F012090	377	776F638	394
715F152	377	741F24	391	754F53	427	763F012120	377	776F648	394
715F245	402	744F208	415	754F54	427	763F012150	377	776F658	394
715F892	378	744F258	415	754F55	427	763F012180	377	776F668	394
715K14	376	744F688	415	754F58	427	763F012210	377	776F678	394
716K16	376	751F16	386	754F59	427	763F012240	377	776F688	394
716K43	376	751F17	386	754F63	427	763F012270	377	776F698	394
716K45	376	753F078	382	754F64	427	763F012300	377	776F708	394
716K46	376	753F098	381	754F66	427	763F012330	377	776F718	394
716K48	376	753F598	395	754F68	424	763F012360	377	776F728	394
720F21	391	753F697	381	754F69	424	763F027120	377	776F738	394
720F22	391	754F02	427	754F70	424	763F027150	377	776F748	394
720F24	391	754F03	427	754F72	427	763F027180	377	776F758	394
720F25	391	754F04	427	754F79	424	763F027210	377	776F768	394
720F43	381	754F05	427	754F80	424	763F027240	377	776F778	394
720F46	381	754F09	425	754F84	426	763F027270	377	776F788	394
720F61	391	754F09	426	754F92	424	763F027300	377	776F798	394
720F62	391	754F10	425	754F93	424	763F072	377	776F808	394
720F64	391	754F10	426	754F94	424	774F225	393	776F818	394
720F65	391	754F12	425	754F95	424	774F878	394	776F828	394
721F16	391	754F12	426	754F96	424	774F888	394	776F838	394
721F17	391	754F13	425	756F507	378	774F945	393	776F848	394
721F18	391	754F13	426	756F507	378	774F965	393	776F858	394
721F19	391	754F14	425	756F517	378	774F985	393	776F868	394
723F26	391	754F14	426	756F517	378	775F808	394	776F878	394
723F69	391	754F15	425	756F527	378	775F818	394	776F918	394
724F278	416	754F15	426	756F527	378	775F828	394	776F928	394
728F709	427	754F16	425	756F537	378	775F838	394	776F938	394
728F759	427	754F16	425	756F537	378	775F908 Fin	395	776F948	394
728F799	427	754F16	426	756F542	378	775F918 Fin	395	776F958	394
728F799	427	754F17	426	756F542	378	775F948	394	776F968	394
728F809	427	754F18	426	756F557	378	776F002 Fin	394	776F978	394
728F939	427	754F20	426	756F557	378	776F012 Fin	394	776F988	394
730F778	415	754F21	426	756F567	378	776F022 Fin	394	776F998	394
733F05	417	754F22	426	756F567	378	776F032 Fin	394	777F208	394
733F41	417	754F23	426	756F582	378	776F042 Fin	394	777F215	393
733F42	417	754F24	426	756F582	378	776F215	393	777F225	393
733F43	417	754F25	426	756F582	378	776F225	393	777F235	393
733F44	417	754F26	426	756F622	378	776F235	393	777F245	393
733F45	417	754F29	426	756F622	378	776F245	393	777F335	393
733F46	417	754F30	426	756F963	412	776F335	393	777F345	393
733F47	417	754F34	426	763F002213	377	776F345	393	777F395	393
733F48	417	754F35	426	763F002243	377	776F395	393	777F405	393
733F49	417	754F36	426	763F002273	377	776F405	393	777F415	393

Part Number	Page	Part Number	Page	Part Number	Page	Part Number	Page	Part Number	Page
777F425	393	779F738	394	785F018 Fin	401	790F235	393	796F398	405
777F515	393	779F748	394	785F028 Fin	401	790F245	393	796F398	405
777F525	393	779F758	394	785F038	401	790F245	393	796F398	407
777F575	393	779F787	395	785F048	401	790F335	393	796F408	405
777F585	393	779F797	395	785F058	401	790F345	393	796F408	407
778F215	393	779F807	395	785F068	401	790F395	393	796F46 x Fin	412
778F225	393	779F97 Fin	393	785F078 Fin	401	790F405	393	797F618	407
778F225	393	779F98 Fin	393	785F088	401	790F415	393	797F628	407
778F235	393	779F99 Fin	393	785F088	401	790F425	393	797F638	407
778F245	393	780F208	395	785F098	401	790F515	393	797F658	407
778F245	393	780F215	393	785F108	401	790F525	393	797F668	407
778F335	393	780F225	393	785F118 Fin	401	790F575	393	797F678	407
778F345	393	780F235	393	785F138 Fin	401	790F585	393	797F688	407
778F395	393	780F245	393	785F148	401	790F988	395	797F698	407
778F405	393	780F335	393	785F158 Fin	401	790F988	395	797F808	407
778F415	393	780F345	393	785F168	401	790F998	395	797F818	408
778F425	393	780F395	393	785F178	401	790F998	395	797F828	406
778F515	393	780F405	393	785F188	401	791F51 x Fin	412	797F828	408
778F525	393	780F415	393	785F198	401	791F59	391	797F838	408
778F575	393	780F425	393	785F218 Fin	401	791F60	391	797F845	406
778F585	393	780F515	393	785F228	401	791F82 Fin	412	797F845	408
778F638	395	780F525	393	785F238	401	791F83 Fin	412	797F855	406
778F759	395	780F575	393	785F248	401	791F84 Fin	412	797F855	408
778F788	394	780F585	393	785F258	401	791F85 Fin	412	797F865	406
778F812	395	780F638	395	785F268 Fin	401	791F86 Fin	412	797F865	408
778F868	395	780F658	394	785F278	401	791F87 Fin	412	797F875	406
778F888	394	780F662	394	785F288	401	792F997	377	797F875	408
778F898	394	780F808	394	785F298	401	794F509	427	797F915	406
778F90 Fin	393	780F81 Fin	394	785F308	401	794F519	427	797F915	408
778F91 Fin	395	780F82 Fin	394	785F318 Fin	401	794F529	427	797F925	406
778F968	395	780F83 Fin	394	785F328	401	794F539	427	797F925	408
778F97 Fin	393	780F84 Fin	394	785F338	401	796F118	406	797F935	406
779F215	393	780F85 Fin	394	785F348	401	796F118	408	797F935	408
779F225	393	780F86 Fin	394	785F358	401	796F208	405	797F945	406
779F235	393	780F87 Fin	394	785F378 Fin	401	796F218	405	797F945	408
779F245	393	780F88 Fin	394	785F388 Fin	401	796F228	405	798F115	406
779F335	393	780F89 Fin	394	789F018	400	796F238	405	798F115	408
779F345	393	780F90 Fin	394	789F028	400	796F248	405	798F125	406
779F395	393	780F91 Fin	394	789F058	400	796F258	405	798F125	408
779F405	393	780F92 Fin	394	789F068	400	796F268	405	798F135	406
779F415	393	780F93 Fin	394	789F228	400	796F30 x Fin	412	798F135	408
779F425	393	780F94 Fin	394	789F859	427	796F318	405	798F145	406
779F515	393	780F95 Fin	394	789F869	427	796F328	405	798F145	408
779F525	393	780F96 Fin	394	789F879	427	796F338	405	798F155	406
779F575	393	783F048	418	789F929	427	796F34	412	798F155	408
779F585	393	783F06	417	790F047	382	796F358	405	798F165	406
779F638	394	783F208	401	790F208	395	796F368	405	798F165	408
779F648	394	783F308	401	790F215	393	796F378	405	798F175	406
779F658	394	783F408	401	790F225	393	796F378	407	798F175	408
779F728	394	785F008	401	790F225	393	796F388	405	798F185	406

Part Number	Page	Part Number	Page	Part Number	Page	Part Number	Page	Part Number	Page
798F185	408	820F168	382	859F072 x Finish	388	860F555	398	860N285	399
798F215	408	852F307	382	859F082 x Finish	388	860F608	397	860N295	399
798F225	408	852F318	382	859F092 x Finish	388	860F618	397	860N305	399
798F235	408	853F05	390	860F005	398	860F628	397	860N315	399
798F245	408	853F865	382	860F015	398	860F638	397	860N325	399
798F255	408	853F875	382	860F025	398	860F648	397	860N335	399
798F265	408	854F00	388	860F035	398	860F655	398	860N345	399
798F275	408	854F01	388	860F045	398	860F665	398	860N355	399
798F285	408	854F03	388	860F055	398	860F685	398	860N405	399
798F295	393	854F04	388	860F065	398	860F705	398	860N415	399
798F305	393	854F05	388	860F075	398	860F715	398	860N425	399
798F395	393	854F06	388	860F085	398	860F735	398	860N435	399
798F405	393	854F08	388	860F095	398	860F755	398	860N445	399
798K912 x Fin	376	854F09	388	860F105	398	860F775	398	860N455	399
798K922 x Fin	376	854F11	384	860F115	398	860F785	398	860N465	399
799F505	402	854F15	384	860F125	398	860F805	398	860N475	399
799F515	402	854F19	384	860F135	398	860F825	398	860N485	399
799F525	402	854F23	384	860F145	398	860F835	398	860N495	399
799F535	402	854F27	384	860F155	398	860F855	398	860N505	399
799F545	402	855F582 x Finish	388	860F205	398	860F875	398	860N515	399
799F555	402	855F592 x Finish	388	860F215	398	860F905	398	860N525	399
799F565	402	855F602 x Finish	388	860F225	398	860F915	398	860N535	399
799F575	402	855F619	388	860F235	398	860F935	398	860N545	399
799F585	402	855F638	388	860F245	398	860F955	398	860N555	399
799F595	402	855F649	388	860F255	398	860F965	398	860R005	399
799F605	403	855F658	388	860F265	398	860F985	398	860R015	399
799F615	403	855F697	388	860F275	398	860N005	399	860R025	399
799F625	403	855F707	388	860F285	398	860N015	399	860R035	399
799F635	403	855F717	388	860F295	398	860N025	399	860R045	399
799F645	403	855F727	388	860F305	398	860N035	399	860R055	399
799F655	403	855F737 x Finish	388	860F315	398	860N045	399	860R065	399
799F665	403	855F747 x Finish	388	860F325	398	860N055	399	860R075	399
799F675	403	855F757 x Finish	388	860F335	398	860N065	399	860R085	399
799F685	403	855F767 x Finish	388	860F345	398	860N075	399	860R095	399
799F695	403	856F049	388	860F355	398	860N085	399	860R105	399
799F805	402	858F241	388	860F405	398	860N095	399	860R115	399
799F815	402	858F251	388	860F415	398	860N105	399	860R125	399
799F825	402	858F261	388	860F425	398	860N115	399	860R135	399
799F835	402	858F271	388	860F435	398	860N125	399	860R145	399
799F845	403	858F281	388	860F445	398	860N135	399	860R155	399
799F855	403	858F291	388	860F455	398	860N145	399	860R205	399
799F865	403	858F497 x Finish	388	860F465	398	860N155	399	860R215	399
799F875	403	858F50M x Finish	388	860F475	398	860N205	399	860R225	399
813F505	382	858F517 x Finish	388	860F485	398	860N215	399	860R235	399
820F008	381	858F52M x Finish	388	860F495	398	860N225	399	860R245	399
820F048	382	858F53M x Finish	388	860F505	398	860N235	399	860R255	399
820F068	382	858F549	388	860F515	398	860N245	399	860R265	399
820F078	382	858F55M x Finish	388	860F525	398	860N255	399	860R275	399
820F088	382	859F052 x Finish	388	860F535	398	860N265	399	860R285	399
820F148	381	859F062 x Finish	388	860F545	398	860N275	399	860R295	399

Part Number	Page	Part Number	Page	Part Number	Page	Part Number	Page	Part Number	Page
860R305	399	861F888 Fin	396	865F398	400	867F37	400	886F36	413
860R315	399	861F898 Fin	396	866F028	396	867F388	400	886F37	413
860R325	399	861F908 Fin	396	866F038	396	867F70 Fin	400	886F38	413
860R335	399	861F918 Fin	396	866F048 Fin	396	867F71 Fin	400	886F39	413
860R345	399	861F928	396	866F058 Fin	396	867F72 Fin	400	886F40	413
860R355	399	861F938	396	866F068 Fin	396	867F73 Fin	400	886F41	413
860R405	399	861F948	396	866F078 Fin	396	867F74 Fin	400	886F42	413
860R415	399	861F958	396	866F088 Fin	396	867F75 Fin	400	886F43	413
860R425	399	861F968	396	866F098 Fin	396	875F42	413	886F44	413
860R435	399	861F978	396	866F108 Fin	396	875F43	413	886F45	413
860R445	399	861F988	396	866F118 Fin	396	875F44	413	886F46	413
860R455	399	861F998	396	866F128 Fin	396	875F45	413	886F47	413
860R465	399	862F008	396	866F138 Fin	396	875F46	413	886F48	413
860R475	399	862F018	396	866F148	396	875F47	413	886F49	413
860R485	399	862F028	396	866F158	396	875F48	413	887F00	413
860R495	399	862F038	396	866F168	396	875F49	413	887F01	413
860R505	399	862F049	397	866F178	396	875F50	413	887F02	413
860R515	399	862F402	397	866F188 Fin	396	875F51	413	887F03	413
860R525	399	862F412	397	866F198 Fin	396	875F52	413	887F04	413
860R535	399	862F472	397	866F208 Fin	396	875F53	413	887F05	413
860R545	399	862F482	397	866F218 Fin	396	881F460	410	887F07	413
860R555	399	862F978	397	866F228	396	881F470	410	887F08	413
861F015	398	862F988	397	866F238	396	881F480	410	887F09	413
861F035	398	862F998	397	866F248	396	881F490	410	887F10	413
861F045	398	863F008	397	866F258	396	885F79	413	887F11	413
861F065	398	863F018	397	866F268	396	885F860	397	887F12	413
861F085	398	863F028	397	866F278	396	886F000	396	887F13	413
861F095	398	863F038	397	866F288	396	886F010	396	887F32	424
861F115	398	863F038	397	866F298	396	886F120	397	889F829	400
861F135	398	863F048	397	866F308	396	886F130	397		
861F358	396	863F048	397	866F318	396	886F140	397		
861F368	396	863F058	397	866F328	396	886F150	397		
861F378	396	863F068	397	866F338	396	886F160	397		
861F388	396	863F078	397	867F20	400	886F170	397		
861F708	396	863F088	397	867F21	400	886F180	397		
861F718	396	863F108	397	867F22	400	886F190	397		
861F728 Fin	396	863F118	397	867F23	400	886F200	397		
861F738 Fin	396	864F107	382	867F24	400	886F210	397		
861F748 Fin	396	864F117	382	867F25	400	886F220	397		
861F758 Fin	396	864F568	397	867F26	400	886F230	397		
861F768 Fin	396	864F568	397	867F27	400	886F240	397		
861F778 Fin	396	864F578	397	867F28	400	886F250	397		
861F788 Fin	396	864F578	397	867F29	400	886F260	397		
861F798 Fin	396	865F199	400	867F30	400	886F270	397		
861F828 Fin	396	865F241	388	867F31	400	886F30	413		
861F838 Fin	396	865F251	388	867F32	400	886F31	413		
861F848	396	865F298	400	867F33	400	886F32	413		
861F858	396	865F308	400	867F34	400	886F33	413		
861F868	396	865F32 x Fin	400	867F35	400	886F34	413		
861F878	396	865F33 x Fin	400	867F36	400	886F35	413		

For more information regarding Corbin Russwin Locksets, Exit Devices, Door Controls and Key Systems, contact your authorized Corbin Russwin Distributor or Sales Representative.

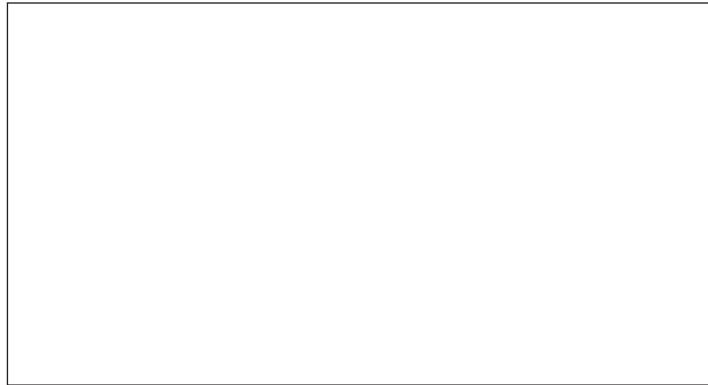

Corbin Russwin Architectural Hardware

225 Episcopal Road
Berlin, CT 06037
Phone 800-543-3658
Fax 800-447-6714
www.corbinrusswin.com

Notice: This price book takes precedence over the catalog as to the correctness and availability of items in our entire line.

Corbin Russwin and Design®, Corbin®, Russwin®, and Design® Access 800®, Muséo®, and SecureBolt® are registered trademarks of Corbin Russwin, Inc., an ASSA ABLOY Group company. Safeguard™, PathLite™ and Vineyard™ are trademarks of Corbin Russwin, Inc. an ASSA ABLOY Group company. Unitrol® is a registered trademark of ASSA ABLOY Access And Door Controls Group, Inc. These materials are protected under US copyright laws. All contents current at time of publication. Corbin Russwin Inc., an ASSA ABLOY Group company reserves the right to change availability of any item in this catalog, its design, construction, and/or its materials. Other products' brand names may be trademarks or registered trademarks of their respective owners and are mentioned for reference purposes only.

Copyright © 2002-2025 Corbin Russwin, Inc., an ASSA ABLOY Group company. All rights reserved. Reproduction in whole or in part without the express written permission of Corbin Russwin, Inc. is prohibited.