

# PRICE LIST

## April 1, 2026

Institutional grade cabinet locks,  
padlocks, and accessories

ANSI/BHMA  
Grade 1 / 2  
Cabinet Locks



COMBI-CAM



DISC

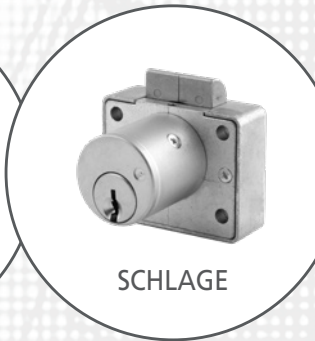

SCHLAGE

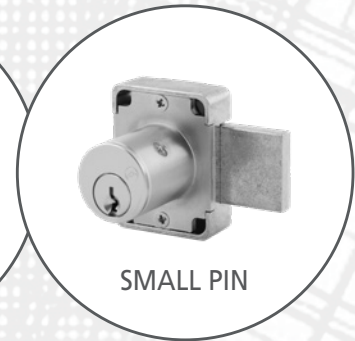

SMALL PIN



ACCESSORIES

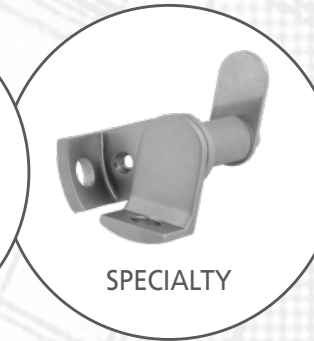

SPECIALTY



IC CORE

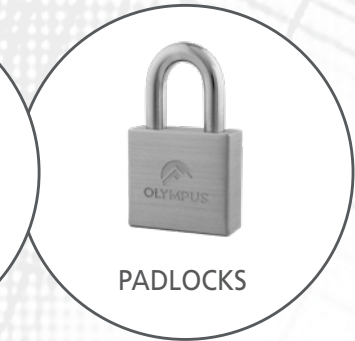

PADLOCKS

206.362.3290  
800.525.0954  
[www.olympuslock.com](http://www.olympuslock.com)



# ABOUT OLYMPUS® LOCK



## Institutional grade cabinet locks

### EXPERIENCE

Olympus Lock has been a trusted leader in lock design and manufacturing for over 35 years, specializing in easily rekeyable pin tumbler, combination, interchangeable core, and engineered cabinet lock bodies for third-party cylinders. We offer a wide selection of keyways and cabinet lock solutions for commercial and institutional facilities. Our design philosophy focuses on creating durable, high-performance locks that enhance operational efficiency and simplify maintenance.

### INNOVATION

We hold numerous U.S. and Canadian patents, proving our commitment to provide innovative solutions for your cabinet lock needs. At Olympus, our goal has always been to create locks that are easy to install, operate, and maintain. Every product is meticulously designed, engineered, and manufactured to precise standards. Additionally, we provide an extensive range of accessories to ensure smooth installation, use, and servicing of our locks.

### SERVICE

Our delivery is the fastest in the industry. We have a vast inventory of off-the-shelf masterkeyed locks and can ship most custom keyed orders within 1-5 business days.

### SPECIFICATIONS

We provide detailed, pre-written architectural specifications for all our locks. Specifications can be obtained directly from our website at [www.olympuslock.com](http://www.olympuslock.com) or found in our Olympus Lock product catalog.

### APPLICATIONS

Olympus cabinet locks are used in a variety of cabinet and casework applications, including: K-12 public schools, colleges and universities, correctional facilities, medical offices, hospitals, casinos, retail cash drawers, lockers, kiosks, retail showcases, airline ticket counters, museums, hotels and motels, amusement parks, theaters, restaurants, country clubs, libraries, airports, police stations, fire stations, and churches.

### PIN TUMBLER SOLUTIONS

Olympus Lock specializes in pin-tumbler cabinet locks designed for institutional and retail applications. Ideal for facilities requiring large-scale lock installations, such as schools, banks, and hospitals, pin tumbler locks offer superior security and support complex master and sub-master keying systems. We provide a variety of cabinet lock solutions that balance cost-effectiveness with high security. Additionally, our locks can be keyed to match your existing door hardware, simplifying access with a convenient "one-key" system.

### ELECTRONIC KEY RECORDS

We manage and store all custom keying records for future reference. Need to add locks to an existing project? No problem. We have your records readily available, making it easy to order additional locks across different job phases. We handle the records so you don't have to.

### CONTACT

Visit our website at [olympuslock.com](http://olympuslock.com), call us toll-free at 800-525-0954, or email us at [info@olympuslock.com](mailto:info@olympuslock.com) for more information. Subscribe online to our eNews list to receive new product announcements and technical bulletins.



# TABLE OF CONTENTS

## REFERENCE

About Olympus Lock.....	2
Replacement Guide.....	4
Handing/Key-Retaining Chart.....	5
Finish Chart.....	5
How to Order.....	5
General Keying Information.....	6

## TERMS, CONDITIONS, WARRANTY

Conditions of Sales.....	51
Cancellation Policy.....	51
Delivery.....	51
Freight Policy.....	51
Minimum Order Amount.....	51
Returned Goods Policy.....	51
Limited Warranty.....	51
California Proposition 65 Statement.....	51

## RIM CYLINDER CONVERSION KIT

### SLT SERIES

SLT-01.....	27
SLT-02.....	27

### COMBI-CAM

#### COMBINATION CAM/LOCKER LOCKS

7850.....	7
7803.....	7
7440/7445.....	8

#### PADLOCKABLE CAM LOCK

##### CAM LOCK/HASP

DCP.....	9
DCP500.....	9
DCP-SP1.....	9

### CASCADE SERIES

#### DISC TUMBLER LOCKS

951-961..... (Grade 2)	10
973-975.....	11
Accessories.....	11

### CCL SERIES

#### DISC TUMBLER LOCKS

266-267.....	12
--------------	----

### SMALL PIN LOCKS

#### N SERIES (NATIONAL KEYWAY)

General Keying Information.....	6
100DR / 100B / 100M..... (Grade 1)	13
200DW / 200B / 200M..... (Grade 1)	14
300SD.....	16
329R.....	16
998.....	17
999.....	17
DCN1,2,3,4..... (Grade 1)	15
FC10/FC26-AR.....	18
L20V.....	17
N078.....	18
T37.....	16
T54C.....	16

#### R SERIES (CCL KEYWAY)

General Keying Information.....	6
---------------------------------	---

500DR / 500B / 500M..... (Grade 1)	19
600DW / 600B / 600M..... (Grade 1)	20
400SD.....	20
429R.....	21
996.....	22
997.....	22
DCR1,2,3,4..... (Grade 1)	21
R078.....	22

## STANDARD CYLINDER LOCKS

### S SERIES (SCHLAGE C KEYWAY)

General Keying Information.....	6
700S..... (Grade 1)	23
800S..... (Grade 1)	23
820S.....	23
829R..... (Grade 1)	24
850S.....	24
L78.....	24

### LC SERIES (LESS CYLINDER/SCHLAGE)

700LC..... (Grade 1)	25
800LC..... (Grade 1)	25
820LC.....	25
829R-LC..... (Grade 1)	26
850LC.....	26
L78LC.....	26

### LC SERIES (LESS CYLINDER/SARGENT)

754LC.....	27
854LC.....	27

## INTERCHANGEABLE CORE LOCKS

### SMALL FORMAT (BEST COMPATIBLE)

General Keying Information.....	6
206/207 SFIC Cylinders.....	39
720..... (Grade 1)	34
720B-DM.....	34
721..... (Grade 1)	35
722.....	34
723.....	34
724VR.....	36
725MD..... (Grade 1)	36
725ML..... (Grade 1)	36
725RD..... (Grade 1)	37
725RL..... (Grade 1)	37
725RSL.....	32
728MBL.....	38
729R..... (Grade 1)	38
950IC.....	38
L72V.....	38

### CORBIN/RUSSWIN

CR1125RD.....	28
CR1125RL.....	28
CR25.....	28

### MEDECO/YALE

931DR.....	29
931DW.....	29
ME93 (For Medeco LFIC).....	29
YA93 (For Yale LFIC).....	30

### SARGENT

SA54.....	30
-----------	----

### SCHLAGE FULL SIZE

777..... (Grade 1)	31
888..... (Grade 1)	31
920..... (Grade 1)	31

929R..... (Grade 1)	32
L92V.....	32

## BEST KEYWAY

### 3/4" UTILITY CAM LOCK

General Keying Information.....	6
B7.....	33
TRB7 Spacer Collars.....	42

## ENCLOSURE LOCKS

### FOR TRAFFIC CONTROL ENCLOSURES

725RSL (SFIC).....	32
E5 (CCL CR KEYWAY).....	32
P3L.....	33

## CYLINDERS

### SFIC & SCHLAGE C KEYWAY

General Keying Information.....	6
206/207 Series SFIC.....	39
78-201 Series Schlage C.....	39
Plastic Thumbturns for IC Locks.....	41

## SAMPLE & SERVICE KITS

### SK SERIES

SK-002, 003, 004, 005, 006.....	47
---------------------------------	----

## CABINET HARDWARE

### WIRE PULL / ELBOW CATCH / SLIDE BOLT

EC Series Elbow Catch.....	45
EC Series Elbow Catch Template.....	45
SB Series Slide Bolt.....	45
102 Series Wire Pull.....	45

## INSTALLATION TOOLS

### DRILL JIG / PUNCH

CL-HIT-25 Cabinet Lock Drill Guide.....	45
CL-MP-118 Double-D Metal Punch.....	45

## PARTS & ACCESSORIES

### PIN/KEYING KITS / ACCESSORIES

N1 & R1.....	46
D1.....	46
Replacement Parts.....	46

### KEYS & KEYING CHARGES

Cut Keys.....	40
Keyblanks.....	40
Grand Master Keying Charges.....	40
Custom Stamping Charges.....	40

### OTHER PARTS & ACCESSORIES

Additional Cabinet Lock Parts.....	48
FDB Display Boards.....	47
Interior Plastic Spacers.....	41
Plastic Thumbturns for IC Locks.....	41
Strikes.....	44
Spacer Collars (for cam locks).....	42
Through-Bolt Plates & Pulls.....	43
Trim Rings.....	42

## PADLOCKS

Corbin Russwin IC Core.....	49
N Series National Keyway Padlocks.....	49
Mountain Series (BP Blister Packed).....	50

# REPLACEMENT GUIDE

Information given is for dimensional and keyway replacement only. Olympus Lock cabinet locks differ from other manufacturer's locks because they are covered by at least two patents and are easily rekeyable in five minutes or less with readily available tools.

CompX/National Cabinet Lock			Olympus Lock N Series		
C8102	Cam Lock	1-1/16"	DCN1	Cam Lock	1-1/16"
C8103	Cam Lock	1-3/16"	DCN2	Cam Lock	1-3/16"
C8106	Cam Lock	1-7/16"	DCN3	Cam Lock	1-7/16"
C8108 C8109	Cam Lock	1-3/4"	DCN4	Cam Lock	1-3/4"
C8173	Door Lock	7/8"	100DR	Door Lock	7/8"
C8174 C8175	Door Lock	1-1/8" 1-3/8"	100DR	Door Lock	1-3/8"
C8178	Drawer Lock	7/8"	200DW	Drawer Lock	7/8"
C8177 C8179	Drawer Lock	1-1/8" 1-3/8"	200DW	Drawer Lock	1-3/8"
C8180	Drawer Lock	1-5/8"	200DW	Drawer Lock	1-5/8"
C8142	Sliding Door	1-1/8"	300SD	Sliding Door	1-1/8"
C8163	Drawer Lock	7/8"	N078	Drawer	1-1/8"
Not Available			N078	Drawer	1-3/8"
Not Available			N078L/R	Door	1-1/8"
Not Available			N078L/R	Door	1-3/8"
C8131	Drawer Latch	7/8"	998/L20V	Drawer Latch	7/8"
Not Available			998/L20V	Drawer Latch	1-3/8"
C8139	Door Latch	3/4"	999	Door Latch	7/8"
Not Available			999	Door Latch	1-3/8"
Not Available			FC10	File Cabinet	n/a
C8137	T-Bolt Drawer	1/4"	T37	T-Bolt Drawer	1/4"
C8140	Ratchet Lock	1/4"	329R	Ratchet Lock	1/4"

CompX Disc Tumbler			Olympus Lock Cascade Series		
C8051	Cam Lock	7/16"	951	Cam Lock	7/16"
C8052	Cam Lock	5/8"	952	Cam Lock	5/8"
C8054	Cam Lock	15/16"	954	Cam Lock	15/16"
C8053	Cam Lock	1-3/16"	953	Cam Lock	1-3/16"
C8055	Cam Lock	1-7/16"	955	Cam Lock	1-7/16"
C8060	Cam Lock	1-3/4"	960	Cam Lock	1-3/4"
C8061	Cam Lock	2"	961	Cam Lock	2"
C8703	Deadbolt Drawer	15/16"	973	Deadbolt Drawer	15/16"
C8704	Deadbolt Door	15/16"	974	Deadbolt Door	15/16"
C8705	Deadbolt Drawer	1-3/16"	975	Deadbolt Drawer	1-3/16"

Best Access	Olympus Lock		
3L	721 Series	Door/Drawer Lock	Deadbolt
5E	B7 Series	Non-IC cam lock	Cam Lock
5L7RD	725RD Series	Door/Drawer Lock	Deadbolt
5L7RL	725RL Series	Door/Drawer Lock	Spring Latch
5L7MD	725MD Series	Door/Drawer Lock	Deadbolt
5L7ML	725ML Series	Door/Drawer Lock	Spring Latch
5L7RD-SL	725RSL Series	Door/Drawer Lock	Square Latch
8L	728MBL	Mailbox Lock	Spring Latch
1E7E4	720 / 720B	Door/Drawer	Cam Lock
1E7D4	720B-DM	Direct Drive	Cam Lock
2P73	724VR	File Cabinet Lock	Round Bolt
2S 2S-TBM	722S 722S-TBM	Plunger Lock	Sliding Door
3S	729R	Ratchet Lock	Sliding Door
4S	723S	Through-glass	Sliding Door
Not Available			
Not Available			
	L72V	Drawer Lock	Spring Latch
	950IC	Drawer Lock	Deadlocking

Corbin/CCL Security Products			Olympus Lock R Series		
15748 15749 15750 15783	Cam Lock	5/8" 13/16" 1" 1"	DCR1	Cam Lock	1-1/16"
15890	Cam Lock	1-5/16"	DCR3	Cam Lock	1-7/16"
0666 1/2	Drawer Latch	7/8"	996	Drawer Latch	7/8"
0666 1/2	Drawer Latch	1-1/8"	996	Drawer Latch	1-3/8"
Not Available			997	Door Latch	7/8"
Not Available			997	Door Latch	1-3/8"
0737	Door Lock	3/4" 7/8"	500DR	Door Lock	7/8"
0737	Door Lock	1-1/8" 1-3/8"	500DR	Door Lock	1-3/8"
0738	Drawer Lock	3/4" 7/8"	600DW	Drawer Lock	7/8"
0738	Drawer Lock	1-1/8" 1-3/8"	600DW	Drawer Lock	1-3/8"
02063	Drawer Lock	7/8"	R078	Drawer Lock	1-1/8"
02291	Sliding Door	7/8"	400SD	Sliding Door	1"
Not Available			429R	Ratchet Lock	1/4"

CCL Security Products		Olympus Lock Enclosure Lock	
15481/55481	Latch Bolt Enclosure Lock	E5L	Latch Bolt Enclosure Lock
A15481/A55481	Dead Bolt Enclosure Lock	E5D	Dead Bolt Enclosure Lock
R557GSG	Latch Bolt/Warded Key	P3L	Latch Bolt/Warded Key

File Cabinet Locks		Olympus Lock* FC10 Series	
HON F24/ F28	HON Original (disc tumbler)	FC10	File Cabinet Lock
SRS2185	SRS Replacement Lock (disc tumbler)	FC10	File Cabinet Lock
HON F26	Hon Original (disc tumbler)	FC10 + FC26-AR	File Cabinet Lock + Adapter Ring
SRS2190	SRS Replacement Lock (disc tumbler)	FC10 + FC26-AR	File Cabinet Lock + Adapter Ring

\*Olympus equivalent locks are on National D4291/D4292 pin tumbler keyway.

Schlage Lock			Olympus Lock* 700/800 Series		
CL100PB	Door Lock	1-1/8"	700SC	Door Lock	1-1/8"
CL100PB	Door Lock	1-3/8"	700SC	Door Lock	1-3/8"
CL200PB	Drawer Lock	1-1/8"	800SC	Drawer Lock	1-1/8"
CL200PB	Drawer Lock	1-3/8"	800SC	Drawer Lock	1-3/8"

\*Olympus provides Schlage C keyway only or less cylinder.

Schlage Lock - FSIC			Olympus Lock* FSIC		
CL777R	Door Lock	1-7/16"	777ICP	Door Lock	1-7/16"
CL888R	Drawer Lock	1-7/16"	888ICP	Drawer Lock	1-7/16"
CL920R	Cam Lock	n/a	920LM/DM	Cam Lock	n/a
CL929R	Ratchet Lock	n/a	929R	Ratchet Lock	n/a

\*Olympus provides lock bodies only (no cylinders) for Schlage full-size (large format) IC cores.

Sargent		Olympus Lock* 754/854 Series		
1654	Door Lock	754LC	Door Lock - less cylinder	
1655	Door Lock	754LC	Door Lock - less cylinder	
Not Available		854LC	Drawer Lock - less cylinder	

\*Locks are less cylinder for use with Sargent original cylinders.

CCL Disc Tumbler			Olympus Lock CCL Series		
02066	Deadbolt Drawer	15/16"	266A	Deadbolt Drawer	15/16"
02066	Deadbolt Drawer	1-1/8"	266B	Deadbolt Drawer	1-1/8"
02067	Deadbolt Door	15/16"	267A	Deadbolt Door	15/16"

# HANDING

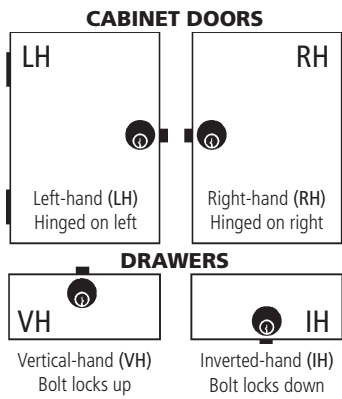

## STANDARD FUNCTION

Key removable in the locked or unlocked position. Locks ship with standard function unless key retaining is specified at time of order.

## KEY RETAINING

The key cannot be removed from the lock while in the "unlocked" position. Key-retaining function is generally used in instances where cabinets or drawers should not be left unlocked.

## HANDING

Handed locks must be ordered either LH, RH, VH or IH (see figure at left).

Non-handed locks can be ordered as either door or drawer. Door locks will work in both LH or RH applications and drawer locks will work for both vertical or inverted function.

# FINISHES

## FINISH CODES

Not all finishes are available on all products. See catalog or price page for the standard finishes available on a specific item.

US Code	BHMA	Description
US10B (10B)	613	Oil rubbed bronze
US19	622	Flat black coated
US26	625	Bright chrome
US26D (26D)	626	Dull chrome
—	14A	Polished nickel

US Code	BHMA	Description
US3	605	Bright brass
US4	606	Satin brass
US32	629	Polished stainless steel
US32D	630	Satin stainless steel

# HOW TO ORDER

## ORDERING LOCKS

Olympus needs certain information about the locks you are ordering to correctly fill your order. For most of our locks you will need to indicate:

- barrel / cylinder length
- finish / color
- keying information KA, KD or MK

## STOCK KEYED LOCKS

**N Series** National keyway (4-pin): KD, KA# 101, 103, 107, 915

- **100/200/DCN Series:** Additional (4-pin) KA# 51001, 51002, 51003, 51004
- **T37 Series:** Additional (4-pin) 51001 to 51011 and 001 to 030

**R Series** CCL R1 keyway (5-pin): KD, KA# 4T2, 4T3

**S Series** Schlage C keyway (5-pin): KD, 0-BIT, KA# 101, 102

## CUSTOM KEYING SERVICES

Olympus Lock offers custom keying services for your special cabinet lock keying needs. We inventory a huge supply of master keyed locks on our most popular keyways so that we can quickly fulfill your custom keyed order. We pride ourselves on being able to ship your master keyed order faster than anyone else in the industry. If you have other special keying needs such as grand master keying or non-stock master keyed systems we will be glad to accommodate you.

## HOW TO ORDER MASTER/CUSTOM KEYED LOCKS

Master keyed or custom keyed locks require detailed information as to the nature of the keying. The more information the better.

All master keyed orders ship standard with 2 change keys per lock and 2 master keys per project (except for IC cores). Additional change keys or master keys can be ordered separately. (See pricing on page 40)

Large keyed alike, master keyed or grand master keyed jobs which include 10 or more KA/MK groups must have a key schedule submitted in written form and reference a "project name" and "project location." It is critical we have "project name" and "project location" information so that we can create a record of your project for future reference in case you need to order replacement locks or keys and add additional groups to your project.

Indicate on your custom keyed lock order if the locks are for a "new" or "existing" project. For existing projects you will need to reference your initial "project name and location" information. We will refer to your project record and original lock schedule(s) so that we can correctly key your order.

For more detailed information about custom keying, master keying and grand master keying, see **Keying Information** on page 6.

# KEYING INFORMATION

## GRAND MASTER KEYING

Before we can create a grand master key system, we need to have a realistic idea of the complete number of masters, sub masters and key codes that the system will require and whether there will be future expansion. Without this information at the beginning of the process, the options for future expansion may be limited. Grand master keying not available for Cascade Series disc tumbler locks.

## SPECIAL STAMPING

Custom (non-stock) lock face and key stamping and/or engraving is available for an additional charge. See page 40 for details and pricing.

## ► N Series Keying

### STOCK KEYING

- 4-pin standard:** KD and KA# 101, 103, 107, 915
- 100/200/DCN: Additional (4-pin) KA# 51001, 51002, 51003, 51004
- T37: Additional (4-pin) KA# 51001 through 51011 and 001 through 030

### STOCK MASTER KEYING

**5-pin standard:** Orders ship with 2 master keys per project and 2 change keys per lock. Includes **4-digit numeric** key code stamped on the change keys and face of lock. Provide key schedule at time of order.

### NON-STOCK MASTER KEYING

- 4-pin:** Orders ship standard with 2 master keys per project and 2 change keys per lock. Includes **3-digit numeric** key code stamped on the change keys and face of lock. Provide key schedule at time of order.
- 5-pin:** Orders ship standard with 2 master keys per project and 2 change keys per lock. Includes **4-digit numeric** key code stamped on the change keys and face of lock. Provide key schedule at time of order.

### GRAND MASTER KEYING

**5-pin:** Orders ship standard with 2 grand master keys per project and 2 change keys per lock. Includes **4-digit numeric** key code stamped on the change keys and face of lock. Provide key schedule and full scope of project at time of order and indicate required number of sub master keys for each group. Sub master keys are charged separately.

## ► Schlage C Keying

### STOCK KEYING

**5-pin standard:** KD and KA# 101, 102

### STOCK MASTER KEYING

**6-pin standard:** Orders ship standard with 2 master keys per project and 2 change keys per lock. Includes numeric key code stamped on the change keys. Lock face stamping available separately. Provide key schedule at time of order.

### NON-STOCK MASTER KEYING

**5-pin:** Locks ship standard with 2 master keys per project and 2 change keys per lock. Includes numeric key code stamped on the change keys. Lock face stamping available separately. Provide key schedule at time of order.

**6-pin:** Locks ship standard with 2 master keys per project and 2 change keys per lock. Includes numeric key code stamped on the change keys. Lock face stamping available separately. Provide key schedule at time of order.

### GRAND MASTER KEYING

- 5-pin:** Orders ship standard with 2 grand master keys per project and 2 change keys per lock. Includes numeric key code stamped on the change keys. Lock face stamping available separately. Provide key schedule and full scope of project at time of order and indicate required number of sub master keys for each group. Sub master keys are charged separately.
- 6-pin:** Orders ship standard with 2 grand master keys per project and 2 change keys per lock. Includes numeric key code stamped on the change keys. Lock face stamping available separately. Provide key schedule and full scope of project at time of order and indicate required number of sub master keys for each group. Sub master keys are charged separately.

## ► R Series Keying

### STOCK KEYING

**5-pin standard:** KD and KA# 4T2, 4T3

### STOCK MASTER KEYING

**5-pin standard:** Orders ship standard with 2 master keys per project and 2 change keys per lock. Includes **3-digit numeric** key code stamped on the change keys and face of lock. Provide key schedule at time of order.

### NON-STOCK MASTER KEYING

- 5-pin:** Orders ship standard with 2 master keys per project and 2 change keys per lock. Includes **3-digit numeric** key code stamped on the change keys and face of lock. Provide key schedule at time of order.
- \*6-pin:** Orders ship standard with 2 master keys per project and 2 change keys per lock. Includes numeric key code stamped on the change keys and face of lock. Provide key schedule at time of order.

### GRAND MASTER KEYING

**5-pin:** Orders ship standard with 2 grand master keys per project and 2 change keys per lock. Includes numeric key code stamped on the change keys and face of lock. Provide key schedule and full scope of project at time of order and indicate required number of sub master keys for each group. Sub master keys are charged separately.

**\*6-pin:** Orders ship standard with 2 grand master keys per project and 2 change keys per lock. Includes numeric key code stamped on the change keys and face of lock. Provide key schedule and full scope of project at time of order and indicate required number of sub master keys for each group. Sub master keys are charged separately.

**\* 6-pin keying note:** Available on 500, 600, 996, and 997 series locks only.

## ► SFIC Keying

### STOCK KEYING

**N/A:** All cores are custom keyed. Specify keyway and type of keying at time of order.

### CUSTOM (KA/KD) / MASTER KEYING

**6-pin or 7-pin:** Orders ship standard with 2 change keys per core. Includes numeric key code stamped on the change keys. 2 additional cut keys (master keys and/or control keys—specify at time of order) are included with each order and/or project. Provide key schedule at time of order. Additional keys may be purchased separately.

### GRAND MASTER KEYING

**6-pin or 7-pin:** Orders ship standard with 2 change keys per core. Includes numeric key code stamped on the change keys. 2 additional cut keys (master keys and/or control keys—specify at time of order) are included with each project. Provide key schedule and full scope of project at time of order and indicate required number of sub master keys for each group. Sub master keys are charged separately.

## ► Cascade Keying

### STOCK KEYING

**5-disc standard:** KD, MKKD [120 codes] and KA# C346A, C390A, C413A, C415A, C420A, C452A

### CUSTOM KEYING

**5-disc standard:** Orders ship with 2 change keys per lock. Master keys must be purchased separately. Lock face stamping/engraving is available for an upcharge. Provide key schedule at time of order. 380 total KD or MKKD codes available if custom keyed. Grand master keying not available.

# COMBI-CAM™ SERIES Combination Cam/Locker Locks

**Function:** Replaces any 3/4" cylinder diameter cam lock  
**Combinations:** 3-Dial up to 1,000 possible codes, 4-Dial up to 10,000 possible codes  
**Resettable:** Easily reset combination

**Secure:** Pick resistant dials  
**Finishes:** Chrome or black finish

## 7850 Combi-Cam 3-Dial



**Description:** Resettable 3-dial combination cam lock. Up to 1,000 possible combinations. **Includes:** Pronged wood washer, fixing nut, 90° stop cam, cam screw and lock washer, and three cams (3/4" straight cam, 1-1/2" straight cam, 1-1/2" x 1/4" reversible offset cam). **Packed 20 per box.**

Item	Finish	Cyl. Length	Fits Material	Weight	Price Each
7850R-S	Chrome	5/8"	3/8"	7.0 lbs/box	\$27.22
7850R-S-BLK	Black				\$30.86
7850R-M	Chrome	7/8"	5/8"	7.6 lbs/box	\$27.22
7850R-M-BLK	Black				\$30.86
7850R-L	Chrome	1-1/8"	7/8"	8.0 lbs/box	\$27.22
7850R-L-BLK	Black				\$30.86
7850R-XL	Chrome	1-3/8"	1-1/8"	8.4 lbs/box	\$27.22
<b>Accessory Items — sold separately</b>					
7850-DC	Dust Cover				\$2.53
7850-FP	Finger Pull				\$2.42
7850-LC-1-19/64	1-19/64" long cam				\$2.04
7850-LC-1-15/16	1-15/16" long cam				\$2.04
7850-OC-1-3/8	1-3/8" long cam with 7/16" offset				\$2.04
7850-OC-60MM	2-1/3" long cam with 1/4" offset				\$2.04

 **WARNING:** This product can expose you to chemicals including chromium, which is known to the State of California to cause cancer and birth defects or other reproductive harm. For more information go to [www.P65Warnings.ca.gov](http://www.P65Warnings.ca.gov).

## 7803 Combi-Cam 4-Dial



**Description:** Resettable 4-dial combination cam lock. Up to 10,000 possible combinations. **Includes:** Pronged wood washer, fixing nut, 90° stop cam, cam screw and lock washer, and two cams (3/4" straight cam, 1-1/2" straight cam). **Packed 20 per box.**

Item	Finish	Cyl. Length	Fits Material	Weight	Price Each
7803S	Chrome	5/8"	3/8"	7.5 lbs/box	\$32.61
7803S-BLK	Black				\$33.18
<b>Accessory Items — sold separately</b>					
7803-FP	Finger Pull				\$3.13
7850-LC-1-19/64	1-19/64" long cam				\$2.04
7850-LC-1-15/16	1-15/16" long cam				\$2.04
7850-OC	1-1/2" long cam with 1/4" offset				\$2.04
7850-OC-1-3/8	1-3/8" long cam with 7/16" offset				\$2.04
7850-OC-60MM	2-1/3" long cam with 1/4" offset				\$2.04

 **WARNING:** This product can expose you to chemicals including chromium, which is known to the State of California to cause cancer and birth defects or other reproductive harm. For more information go to [www.P65Warnings.ca.gov](http://www.P65Warnings.ca.gov).

# COMBI-CAM™ SERIES Combination Cam/Locker Locks

## 7440/7445 Combi-Cam Ultra (Dual Access)



**Description:** Resettable 3-dial/4-dial combination cam/locker lock with key override and code retrieval. 7440: Up to 1,000 possible combinations. 7445: Up to 10,000 possible combinations. **Includes:** 1-1/2" straight cam, cylinder nut, screw and washer. **NOTE:** Does not include override keys. Override keys sold separately. **Packed 20 per box.**

Item	Style	Finish	Cyl. Length	Fits Material	Override Key Code	Price Each
7440S-KA374 7440S-BLK-KA168	3-Dial	Chrome Black	5/8"	3/8"	374 168	\$71.96 \$73.92
7440M-KA374 7440M-BLK-KA168	3-Dial	Chrome Black	7/8"	5/8"	374 168	\$71.96 \$73.92
7440L-KA374 7440L-BLK-KA168	3-Dial	Chrome Black	1-1/8"	7/8"	374 168	\$71.96 \$73.92



Item	Style	Finish	Cyl. Length	Fits Material	Override Key Code	Price Each
7445S-KA374 7445S-KA401	4-Dial	Chrome	5/8"	3/8"	374 401	\$78.35 \$78.35
7445S-BLK-KA168 7445S-BLK-KA401	4-Dial	Black	5/8"	3/8"	168 401	\$84.55 \$84.55
7445M-KA374 7445M-KA401	4-Dial	Chrome	7/8"	5/8"	374 401	\$78.35 \$78.35
7445M-BLK-KA374 7445M-BLK-KA401	4-Dial	Black	7/8"	5/8"	374 401	\$84.55 \$84.55
7445L-KA374 7445L-KA401	4-Dial	Chrome	1-1/8"	7/8"	374 401	\$78.35 \$78.35
7445L-BLK-KA374 7445L-BLK-KA401	4-Dial	Black	1-1/8"	7/8"	374 401	\$84.55 \$84.55

**Override Key Sets [2 keys per set] sold separately \*\*\* Keys are not included with locks \*\*\***

7440-KEYS-168 / 7445-KEYS-168	Override key set - code #168	Match override key code to lock code.	\$16.11
7440-KEYS-374 / 7445-KEYS-374	Override key set - code #374		\$16.11
7445-KEYS-401	Override key set - code #401		\$16.11



**WARNING:** This product can expose you to chemicals including chromium, which is known to the State of California to cause cancer and birth defects or other reproductive harm. For more information go to [www.P65Warnings.ca.gov](http://www.P65Warnings.ca.gov).

### STRAIGHT CAMS FOR 7440/7445

SKU	Cam Type	Length *	Price Ea.
130049	Straight	5/8"	\$2.04
130050D	Straight	3/4"	\$2.04
130031D	Straight	1-1/8"	\$2.04
130147D	Straight	1-1/4"	\$2.04
130023D	Straight	1-1/2"	\$2.04
130058	Straight	1-5/8"	\$2.04
130056D**	Straight	2"	\$2.04
PL32001	Hook	1-1/4"	\$2.04

\*CAM LENGTH = The distance from the center of the mounting hole to the top of the cam.

\*\*NON-STOCK CAMS = Available via special order. Requires minimum purchase of 20 pcs per item.

### OFFSET CAMS FOR 7440/7445

SKU	Cam Type	Length *	Offset	Price Ea.
30597D	Offset	2-1/4"	1/4"	\$2.04
30596D	Offset	2"	1/2"	\$2.04
30002D	Offset	1-5/8"	3/8"	\$2.04
30026D	Offset	1-1/2"	1/4"	\$2.04
30025D**	Offset	1-1/2"	1/8"	\$2.04
30027D**	Offset	1-1/2"	1/2"	\$2.04
30594D	Offset	1-1/4"	1/4"	\$2.04
30593D**	Offset	1-1/4"	1/8"	\$2.04
30595D	Offset	1-1/4"	1/2"	\$2.04
PL39001	Hook	1-1/2"	1/4"	\$2.04



**WARNING:** This product can expose you to chemicals including chromium, which is known to the State of California to cause cancer and birth defects or other reproductive harm. For more information go to [www.P65Warnings.ca.gov](http://www.P65Warnings.ca.gov).

# DCP SERIES Padlockable Cam Lock

**Function:** Uses padlock as locking device.  
**Compatibility:** Accepts most standard padlocks with a shackle diameter of 3/8" (10 mm) or less.

**Padlocks:** See padlocks on pages 49 and 50

## DCP Padlockable Cam Lock



**Standard:** DCP ships standard with DCP-LC cam and spur washer. **Packed 10 per box.**

Item	Finish	Fits Material	Description	Weight	Price Each
DCP	US26D, US26, US3, US19	1-7/32"	Accepts most standard padlocks	3.9 lbs/box	\$15.04
DCNP-500-ARP	Anti-rotation plate (available separately)				\$1.17

See chart below for additional cams.



**WARNING:** This product can expose you to chemicals including chromium, which is known to the State of California to cause cancer and birth defects or other reproductive harm. For more information go to [www.P65Warnings.ca.gov](http://www.P65Warnings.ca.gov).

## DCP500 Padlockable Cam Lock (with finger pull)



**Standard:** DCP500 ships standard with DCP-LC cam and spur washer. **Packed 10 per box.**

Item	Finish	Fits Material	Description	Weight	Price Each
DCP500	US26, US26D	1-7/32"	Accepts most standard padlocks	4.1 lbs/box	\$16.68
DCNP-500-ARP	Anti-rotation plate (available separately)				\$1.17

See chart below for additional cams.



**WARNING:** This product can expose you to chemicals including chromium, which is known to the State of California to cause cancer and birth defects or other reproductive harm. For more information go to [www.P65Warnings.ca.gov](http://www.P65Warnings.ca.gov).

### STRAIGHT CAMS FOR DCP OR DCP500

Cam	Cam Type	Description	Price Each
DCP-SC	Straight	7/8" short straight cam	\$1.77
DCP-LC	Straight	1-1/4" long straight cam	\$2.23
DCP-LC-112	Straight	1-1/2" long straight cam	\$2.23
DCP-LC-134	Straight	1-3/4" long straight cam	\$2.23
DCP-LC-225	Straight	2-1/4" long straight cam	\$2.36
DCP-LC-250	Straight	2-1/2" long straight cam	\$2.36

### OFFSET CAMS FOR DCP OR DCP500

Cam	Cam Type	Description	Price Each
DCP-1-14	Offset	1" long cam with 1/4" offset	\$2.23
DCP-LBC	Offset	1-1/4" long cam with 1/4" offset	\$2.23
DCP-118-18	Offset	1-1/8" long cam with 1/8" offset	\$2.23
DCP-LBC-138	Offset	1-3/8" long cam with 3/8" offset	\$2.36
DCP-LBC-178	Offset	1-7/8" long cam with 1/2" offset	\$2.36
DCP-112-14	Offset	1-1/2" long cam with 1/4" offset	\$2.36
DCP-114-18	Offset	1-1/4" long cam with 1/8" offset	\$2.36
DCP-114-38	Offset	1-1/4" long cam with 3/8" offset	\$2.36



**WARNING:** This product can expose you to chemicals including chromium, which is known to the State of California to cause cancer and birth defects or other reproductive harm. For more information go to [www.P65Warnings.ca.gov](http://www.P65Warnings.ca.gov).

## DCP-SP1 Padlock Bumper Plate



DCP-SP2  
Left-hand

DCP-SP1  
Right-hand



DCP and padlock  
sold separately.

**Function:** Protects face of cabinet from padlock. **Packed each.**

Item	Finish	Approx. Size	Description	Price Each
DCP-SP1	US32, US26D	2" x 4"	Padlock bumper plate	\$18.43
DCP-SP2	US32, US26D	2" x 4"	Padlock bumper plate	\$18.43



**WARNING:** This product can expose you to chemicals including chromium, which is known to the State of California to cause cancer and birth defects or other reproductive harm. For more information go to [www.P65Warnings.ca.gov](http://www.P65Warnings.ca.gov).

# CASCADE SERIES Disc Tumbler Locks

**Keyway:** Cascade Series (equivalent to National 5-disc system). Will key together with CompX National disc tumbler locks.  
**Testing:** Passed ANSI/BHMA A156.11 Grade 2 cycle test  
**Stock keying:** KD (120 KD codes), MKKD (120 MKKD codes)

**Stock KA#:** C346A, C390A, C413A, C415A, C420A, C452A  
**Custom keying:** MKKA or combination of MKKA/MKKD\* to schedule (\*NOTE: there are a maximum of 380 MKKD codes if custom keyed. If you require more key codes, see our DCN Series locks.

**Keyblanks:**  
 KB-D85-C-NP for NON-MK locks  
 KB-D83-D-NP for MK locks  
**Keying Kit:** D1 (can be used for KA, KD or MK)

## 951 - 961 Disc Tumbler Cam Locks

**Standard function:** Key removable in locked or unlocked position. Standard locks are non-handed. **Key-retaining:** For key removable in locked position only, call factory for price and availability. **Packed 15 per box, 120 per case.**



14A finish  
[bright nickel]



US19 finish  
[matte black]

Item	Finish	Cylinder Length	For Max. Material	Disc Keying	Weight	Price Each
951	14A	7/16"	7/64"	Stock KD or KA	3.1 lbs/box	\$10.70
				Stock MK & KD		\$14.72
				Non stock / custom keyed		\$17.53
952	14A	5/8"	15/64"	Stock KD or KA	2.35 lbs/box	\$10.70
				Stock MK & KD		\$14.72
				Non stock / custom keyed		\$17.53
954	14A	15/16"	5/8"	Stock KD or KA	3.15 lbs/box	\$10.70
				Stock MK & KD		\$14.72
				Non stock / custom keyed		\$17.53
953	14A	1-3/16"	7/8"	Stock KD or KA	3.5 lbs/box	\$10.70
				Stock MK & KD		\$14.72
				Non stock / custom keyed		\$17.53
955	14A	1-7/16"	1-1/8"	Stock KD or KA	3.8 lbs/box	\$10.70
				Stock MK & KD		\$14.72
				Non stock / custom keyed		\$17.53
960	14A	1-3/4"	1-7/16"	Stock KD or KA	4.2 lbs/box	\$15.08
				Stock MK & KD		\$18.93
				Non stock / custom keyed		\$20.92
961	14A	2"	1-13/16"	Stock KD or KA	4.55 lbs/box	\$17.07
				Stock MK & KD		\$20.98
				Non stock / custom keyed		\$24.67
951	US19	7/16"	7/64"	Stock KD or KA	3.1 lbs/box	\$15.32
				Stock MK & KD		\$18.00
				Non stock / custom keyed		\$20.10
952	US19	5/8"	15/64"	Stock KD or KA	2.35 lbs/box	\$15.32
				Stock MK & KD		\$18.00
				Non stock / custom keyed		\$20.10
954	US19	15/16"	5/8"	Stock KD or KA	3.15 lbs/box	\$15.32
				Stock MK & KD		\$18.00
				Non stock / custom keyed		\$20.10
953	US19	1-3/16"	7/8"	Stock KD or KA	3.5 lbs/box	\$15.32
				Stock MK & KD		\$18.00
				Non stock / custom keyed		\$20.10
955	US19	1-7/16"	1-1/8"	Stock KD or KA	3.8 lbs/box	\$15.32
				Stock MK & KD		\$18.00
				Non stock / custom keyed		\$20.10
960	US19	1-3/4"	1-7/16"	Stock KD or KA	4.2 lbs/box	\$19.63
				Stock MK & KD		\$21.62
				Non stock / custom keyed		\$25.72
961	US19	2"	1-13/16"	Stock KD or KA	4.55 lbs/box	\$21.51
				Stock MK & KD		\$24.07
				Non stock / custom keyed		\$27.46

## KEY RETAINING ACCESSORIES For Cascade Series Cam Locks (953 - 961)

Cam	Description	Price Each
P95-KR-SC	Key retaining shim + factory installation into lock	\$3.60
P95-KR-SHIM	Key retaining shims (each)	\$0.50
P95-KR-SHIM-50PK	Key retaining shims (pack of 50)	\$20.00



**WARNING:** This product can expose you to chemicals including chromium, which is known to the State of California to cause cancer and birth defects or other reproductive harm. For more information go to [www.P65Warnings.ca.gov](http://www.P65Warnings.ca.gov).

# CASCADE SERIES Disc Tumbler Locks

## 973-975 Disc Tumbler Deadbolt Locks



**973/975**  
Drawer Lock



**974**  
Door Lock

14A finish  
[bright nickel]



**973/975**  
Drawer Lock



**974**  
Door Lock

US19 finish  
[matte black]

Standard function: Key removable in locked or unlocked position. Barrel Diameter: 7/8". Packed 15 per box, 120 per case.

Item	Function	Finish	Barrel Length	Disc Keying	Weight	Price Each
973	Drawer Lock	14A	15/16"	Stock KD or KA	4.1 lbs/box	\$14.70
				Stock MK & KD		\$18.40
				Non stock / custom keyed		\$20.50
975	Drawer Lock	14A	1-3/16"	Stock KD or KA	4.7 lbs/box	\$15.20
				Stock MK & KD		\$18.90
				Non stock / custom keyed		\$21.00
974	Door Lock	14A	15/16"	Stock KD or KA	4.1 lbs/box	\$14.70
				Stock MK & KD		\$18.40
				Non stock / custom keyed		\$20.50
973	Drawer Lock	US19	15/16"	Stock KD or KA	4.1 lbs/box	\$16.78
				Stock MK & KD		\$21.25
				Non stock / custom keyed		\$23.50
975	Drawer Lock	US19	1-3/16"	Stock KD or KA	4.7 lbs/box	\$17.90
				Stock MK & KD		\$22.40
				Non stock / custom keyed		\$24.65
974	Door Lock	US19	15/16"	Stock KD or KA	4.1 lbs/box	\$16.78
				Stock MK & KD		\$21.25
				Non stock / custom keyed		\$23.50



**WARNING:** This product can expose you to chemicals including chromium, which is known to the State of California to cause cancer and birth defects or other reproductive harm. For more information go to [www.P65Warnings.ca.gov](http://www.P65Warnings.ca.gov).

## CASCADE SERIES Accessories

### CAMS For 951 - 961 Cascade Series Cam Locks

Cam	Cam Type	Description / Packed Each	Price Each	Item	Description / Packed Each	Price Each
P95-CM-1	Straight	1-1/2" long straight cam	\$1.76	P95-SPW	eyelet spur washer	\$1.03
P95-CM-2	Offset	1-1/8" long cam with 11/32" offset	\$2.50	P95-FN-Z	fixing nut	\$1.11
P95-CM-3	Straight	3" long straight cam	\$1.98	P95-TR-14A	trim ring, 14A	\$1.24
P95-CM-4	Offset	1-5/8" long cam with 5/16" offset	\$2.50	P95-TR-US19	trim ring, US19	\$1.72
P95-CM-5	Hook	1-1/2" straight hook cam	\$2.12	P95-RS	plug retainer staple	\$1.09
P95-CM-6	Straight	1" straight cam	\$1.76			
P95-CM-7	Straight	5/8" straight cam	\$1.76			

### KEYS / KEYING KIT For Cascade Series Disc Tumbler Locks

Item	Description	Price Each
KB-D85-C-NP	Key blank (for NON-MK locks)	\$1.80
KB-D85-C-CUST	Custom cut change key (for NON-MK locks)	\$5.29
KB-D83-D-NP	Key blank (for MK locks)	\$1.80
KB-D83-D-CUST	Custom cut change key (for MK locks)	\$5.29
KB-D84-E-MK	Cut master key E41A (for MK locks)	\$5.29
KB-D85-C346A	Cut key for stock KA #C346A	\$5.29
KB-D85-C390A	Cut key for stock KA #C390A	\$5.29
KB-D85-C413A	Cut key for stock KA #C413A	\$5.29
KB-D85-C415A	Cut key for stock KA #C415A	\$5.29
KB-D85-C420A	Cut key for stock KA #C420A	\$5.29
KB-D85-C452A	Cut key for stock KA #C452A	\$5.29
D1	Keying kit for KA, KD, MK	\$109.07



**WARNING:** This product can expose you to chemicals including chromium, which is known to the State of California to cause cancer and birth defects or other reproductive harm. For more information go to [www.P65Warnings.ca.gov](http://www.P65Warnings.ca.gov).

# CCL Disc Tumbler Locks

**Keyway:** CCL Disc Tumbler

**Stock keying:** KD (120 KD codes), KA# AUE1, AUE48, AUE8, CAT30, CAT60

**Master keying:** Not available

**Keyblanks:**

KB-C5D-NP - CCL 5 disc key blank  
KB-C6D-NP - CCL 6 disc key blank

**Cut Keys:**

KB-AUE1-NP, KB-AUE8-NP,  
KB-AUE48-NP, KB-CAT30-NP,  
KB-CAT60-NP

## 266-267 Disc Tumbler Deadbolt Locks

**Standard function:** Key removable in locked or unlocked position. **Barrel Diameter:** 7/8". **Packed 15 per box, 120 per case.**



266A, 266B  
Drawer



267A  
Door

Item	Function	Finish	Barrel Length	Disc Keying	Weight	Price Each
266A	Drawer Lock	26D	15/16"	Stock KD or KA# AUE1, AUE8, AUE48, CAT30, CAT60	4.1 lbs/box	\$12.00
266B	Drawer Lock	26D	1-1/8"	Stock KD or KA# AUE1, AUE8, AUE48, CAT30, CAT60	4.3 lbs/box	\$12.00
267A	Door Lock	26D	15/16"	Stock KD or KA# AUE1, AUE8, AUE48, CAT30, CAT60	4.1 lbs/box	\$12.00



**WARNING:** This product can expose you to chemicals including chromium, which is known to the State of California to cause cancer and birth defects or other reproductive harm. For more information go to [www.P65Warnings.ca.gov](http://www.P65Warnings.ca.gov).

### CCL SERIES — DISC TUMBLER

#### KEYBLANKS

Item	Description	Price Each
KB-C5D-NP	CCL 5 disc keyblank	\$1.80
KB-C6D-NP	CCL 6 disc keyblank	\$1.80

#### CUT KEYS

Item	For Schlage C Keyway Locks	Price Each
KB-AUE1-NP	Cut key for KA# AUE1	\$5.29
KB-AUE8-NP	Cut key for KA# AUE8	\$5.29
KB-AUE48-NP	Cut key for KA# AUE48	\$5.29
KB-CAT30-NP	Cut key for KA# CAT30	\$5.29
KB-CAT60-NP	Cut key for KA# CAT60	\$5.29

# N SERIES Key together with other N Series Locks

**Keyway:** National D4291(4-pin) or D4292 (5-pin) keyway  
**Stock KD/KA:** 4 pin standard  
**Stock KA#:** 101, 103, 107, 915  
**Stock KA#:** 51001 through 51011 (not available on all items)

**Stock master keyed:** 5 pin standard  
**Pin Kit:** Use N1 Pin Kit for rekeying  
**Keyblanks:** 4-pin use KBN-4-NP (equivalent to NA14, 1069L), 5-pin use KBN-5-NP (equivalent to NA12, 1069LA). See page 37 for cut keys and keyblanks.

**Accessories:** Additional accessories available for these products. See accessories section or consult factory.  
**Custom stamping:** See page 40.  
**Keying information:** See page 6.

## 100DR / 100B Door Deadbolt Lock



ANSI/BHMA A156.11  
 Grade 1, E07121  
 Woodwork Institute (WI)  
 acknowledged product

**Standard function:** Key removable in locked or unlocked position. Standard locks are non-handed. **Key-retaining:** For key removable in locked position only, specify the key-retaining part-numbers. See handing chart on page 5 for proper handing of locks (left or right).  
**Packed 10 per box.**

Item	Finish	Fits Material	Pinning	Pin Tumbler Keying	Weight	Price Each
100DR	26D, US4	7/8"	4 pin	KD, KA 101,103,107,915,51001,51002,51003,51004	4.8 lbs/box	\$42.19
100DR	26D, US4	7/8"	5 pin	Stock master keyed or non stock KD, KA	4.8 lbs/box	\$46.48
100DR	26D, US4	1-3/8"	4 pin	KD, KA 101,103,107,915,51001,51002,51003,51004	5.5 lbs/box	\$42.19
100DR	26D, US4	1-3/8"	5 pin	Stock master keyed or non stock KD, KA	5.5 lbs/box	\$46.48
100DR	US19	7/8"	4 pin	KD, KA 101,103,107,915,51001,51002,51003,51004	4.8 lbs/box	\$54.93
100DR	US19	7/8"	5 pin	Stock master keyed or non stock KD, KA	4.8 lbs/box	\$58.58
100DR	10B	7/8"	4 pin	KD, KA 101,103,107,915,51001,51002,51003,51004	4.8 lbs/box	\$63.39
100DR	10B	7/8"	5 pin	Stock master keyed or non stock KD, KA	4.8 lbs/box	\$67.30
100DR	10B	1-3/8"	4 pin	KD, KA 101,103,107,915,51001,51002,51003,51004	5.5 lbs/box	\$63.39
100DR	10B	1-3/8"	5 pin	Stock master keyed or non stock KD, KA	5.5 lbs/box	\$67.30
<b>Key-retaining:</b> Specify item <b>100KL</b> for left-hand doors and <b>100KR</b> for right-hand doors. ( <b>KL</b> and <b>KR</b> designation are only required for key retaining locks). Standard locks are non-handed.					<b>Add on price</b>	<b>\$7.76</b>
<b>Grand master (3-level system), or systems with multiple master keys:</b> Add to the "Stock master keyed or non stock KD, KA" price. Great grand master keyed (4-level system or higher), call factory for price.					<b>Add on price</b>	<b>\$17.64</b>
<b>100B</b>	<b>Weather resistant:</b> Includes weather resistant components. Suitable for outdoor use in covered areas only. Specify <b>100B</b> series. Include finish, barrel length and keying.				<b>Add on price</b>	<b>\$9.36</b>
<b>Long bolt:</b> For long bolt #15-1-35 factory installed in lock (specify <b>-LB</b> option). Bolts available separately for \$12.65 list price each. Extends bolt projection to 1-1/2".					<b>Add on price</b>	<b>\$20.06</b>



**WARNING:** This product can expose you to chemicals including chromium, which is known to the State of California to cause cancer and birth defects or other reproductive harm. For more information go to [www.P65Warnings.ca.gov](http://www.P65Warnings.ca.gov).

## 100M Door Deadbolt Lock (MRI Series)



ANSI/BHMA A156.11  
 Grade 1, E07121  
 Woodwork Institute (WI)  
 acknowledged product

**100M MRI Series:** Include all non-ferrous (non-magnetic) metals and materials and are suitable for use in medical applications including Magnetic Resonance Imaging (MRI) suites due to their non-magnetic properties. **Standard function:** Key removable in locked or unlocked position. Standard locks are non-handed. **Key-retaining:** For key removable in locked position only, specify the key-retaining part-numbers. See handing chart on page 5 for proper handing of locks (left or right). **Keys:** Includes copper plated non-magnetic keys (KBN-5B).  
**Packed 10 per box.**

Item	Finish	Fits Material	Pinning	Pin Tumbler Keying	Weight	Price Each
100M	26D	7/8"	4 pin	KD, KA 101,103,107,915,51001,51002,51003,51004	4.8 lbs/box	\$54.46
100M	26D	7/8"	5 pin	Stock master keyed or non stock KD, KA	4.8 lbs/box	\$58.75
100M	26D	1-3/8"	4 pin	KD, KA 101,103,107,915,51001,51002,51003,51004	5.5 lbs/box	\$54.46
100M	26D	1-3/8"	5 pin	Stock master keyed or non stock KD, KA	5.5 lbs/box	\$58.75
<b>Key-retaining:</b> Specify item <b>100MKL</b> for left-hand doors and <b>100MKR</b> for right-hand doors. ( <b>MKL</b> and <b>MKR</b> designation are only required for key retaining locks). Standard locks are non-handed.					<b>Add on price</b>	<b>\$7.76</b>
<b>Grand master (3-level system), or systems with multiple master keys:</b> Add to the "Stock master keyed or non stock KD, KA" price. Great grand master keyed (4-level system or higher), call factory for price.					<b>Add on price</b>	<b>\$17.64</b>
<b>Long bolt:</b> For long bolt #15-1-35 factory installed in lock (specify <b>-LB</b> option). Bolts available separately for \$12.65 list price each. Extends bolt projection to 1-1/2".					<b>Add on price</b>	<b>\$20.06</b>



**WARNING:** This product can expose you to chemicals including chromium, which is known to the State of California to cause cancer and birth defects or other reproductive harm. For more information go to [www.P65Warnings.ca.gov](http://www.P65Warnings.ca.gov).

# N SERIES Key together with other N Series Locks

## 200DW / 200B Drawer Deadbolt Lock



ANSI/BHMA A156.11  
Grade 1, E07041  
Woodwork Institute (WI)  
acknowledged product

**Standard function:** Key removable in locked or unlocked position. Standard locks are non-handed. **Key-retaining:** For key removable in locked position only, specify the key-retaining part-numbers. See the handing chart on page 5 for proper handing of locks (vertical or inverted).  
Packed 10 per box.

Item	Finish	Fits Material	Pinning	Pin Tumbler Keying	Weight	Price Each	
200DW	26D, US4	7/8"	4 pin	KD, KA 101,103,107,915,51001,51002,51003,51004	4.8 lbs/box	\$42.19	
200DW	26D, US4	7/8"	5 pin	Stock master keyed or non stock KD, KA	4.8 lbs/box	\$46.48	
200DW	26D, US4	1-3/8"	4 pin	KD, KA 101,103,107,915,51001,51002,51003,51004	5.5 lbs/box	\$42.19	
200DW	26D, US4	1-3/8"	5 pin	Stock master keyed or non stock KD, KA	5.5 lbs/box	\$46.48	
200DW	26D	1-5/8"	4 pin	KD, KA 101,103,107,915,51001,51002,51003,51004	5.8 lbs/box	\$45.23	
200DW	26D	1-5/8"	5 pin	Stock master keyed or non stock KD, KA	5.8 lbs/box	\$49.44	
200DW	US19	7/8"	4 pin	KD, KA 101,103,107,915,51001,51002,51003,51004	4.8 lbs/box	\$54.93	
200DW	US19	7/8"	5 pin	Stock master keyed or non stock KD, KA	4.8 lbs/box	\$58.58	
200DW	US19	1-3/8"	4 pin	KD, KA 101,103,107,915,51001,51002,51003,51004	5.5 lbs/box	\$54.93	
200DW	US19	1-3/8"	5 pin	Stock master keyed or non stock KD, KA	5.5 lbs/box	\$58.58	
200DW	10B	7/8"	4 pin	KD, KA 101,103,107,915,51001,51002,51003,51004	4.8 lbs/box	\$63.39	
200DW	10B	7/8"	5 pin	Stock master keyed or non stock KD, KA	4.8 lbs/box	\$67.30	
200DW	10B	1-3/8"	4 pin	KD, KA 101,103,107,915,51001,51002,51003,51004	5.5 lbs/box	\$63.39	
200DW	10B	1-3/8"	5 pin	Stock master keyed or non stock KD, KA	5.5 lbs/box	\$67.30	
200DW	10B	1-5/8"	4 pin	KD, KA 101,103,107,915,51001,51002,51003,51004	5.8 lbs/box	\$67.05	
200DW	10B	1-5/8"	5 pin	Stock master keyed or non stock KD, KA	5.8 lbs/box	\$70.99	
<b>Key-retaining:</b> Specify item <b>200KI</b> for inverted drawers and <b>200KV</b> for vertical drawers. (KI and KV designations are only required for key retaining locks). Standard locks are non-handed.						Add on price	\$7.76
<b>Grand master (3-level system), or systems with multiple master keys:</b> Add to the "Stock master keyed or non stock KD, KA" price. Great grand master keyed (4-level system or higher), call factory for price.						Add on price	\$17.64
<b>200B</b>	<b>Weather resistant:</b> Includes weather resistant components. Suitable for outdoor use in covered areas only. Specify <b>200B</b> series. Include finish, barrel length and keying.					Add on price	\$9.36
<b>Long bolt:</b> For long bolt #15-1-35 factory installed in lock (specify <b>-LB</b> option). Bolts available separately for \$12.65 list price each. Extends bolt projection to approximately 1-1/2".						Add on price	\$20.06



**WARNING:** This product can expose you to chemicals including chromium, which is known to the State of California to cause cancer and birth defects or other reproductive harm. For more information go to [www.P65Warnings.ca.gov](http://www.P65Warnings.ca.gov).

## 200M Drawer Deadbolt Lock (MRI Series)



ANSI/BHMA A156.11  
Grade 1, E07041  
Woodwork Institute (WI)  
acknowledged product

**200M MRI Series:** Include all non-ferrous (non-magnetic) metals and materials and are suitable for use in medical applications including Magnetic Resonance Imaging (MRI) suites due to their non-magnetic properties. **Standard function:** Key removable in locked or unlocked position. Standard locks are non-handed. **Key-retaining:** For key removable in locked position only, specify the key-retaining part-numbers. See handing chart on page 5 for proper handing of locks (vertical or inverted). **Keys:** Includes copper plated non-magnetic keys (KBN-5B).  
Packed 10 per box.

Item	Finish	Fits Material	Pinning	Pin Tumbler Keying	Weight	Price Each	
200M	26D	7/8"	4 pin	KD, KA 101,103,107,915,51001,51002,51003,51004	4.8 lbs/box	\$54.46	
200M	26D	7/8"	5 pin	Stock master keyed or non stock KD, KA	4.8 lbs/box	\$58.75	
200M	26D	1-3/8"	4 pin	KD, KA 101,103,107,915,51001,51002,51003,51004	5.5 lbs/box	\$54.46	
200M	26D	1-3/8"	5 pin	Stock master keyed or non stock KD, KA	5.5 lbs/box	\$58.75	
200M	26D	1-5/8"	4 pin	KD, KA 101,103,107,915,51001,51002,51003,51004	5.8 lbs/box	\$57.00	
200M	26D	1-5/8"	5 pin	Stock master keyed or non stock KD, KA	5.8 lbs/box	\$61.19	
<b>Key-retaining:</b> Specify item <b>200MKI</b> for inverted drawers and <b>200MKV</b> for vertical drawers. (MKI and MKV designations are only required for key retaining locks). Standard locks are non-handed.						Add on price	\$7.76
<b>Grand master (3-level system), or systems with multiple master keys:</b> Add to the "Stock master keyed or non stock KD, KA" price. Great grand master keyed (4-level system or higher), call factory for price.						Add on price	\$17.64
<b>Long bolt:</b> For long bolt #15-1-35 factory installed in lock (specify <b>-LB</b> option). Bolts available separately for \$12.65 list price each. Extends bolt projection to approximately 1-1/2".						Add on price	\$20.06



**WARNING:** This product can expose you to chemicals including chromium, which is known to the State of California to cause cancer and birth defects or other reproductive harm. For more information go to [www.P65Warnings.ca.gov](http://www.P65Warnings.ca.gov).

# N SERIES Key together with other N Series Locks

## DCN Cam Lock



ANSI/BHMA A156.11  
Grade 1  
E07261 / E07271  
Woodwork Institute (WI)  
acknowledged products

**Standard function:** Key removable in locked or unlocked position. Ships with DCNP-500-ARP (anti-rotation plate), DCNP-100-SC (straight cam) and DCNP-100-BC (reversible offset cam). **Key-retaining:** For key removable in locked position only (key-retaining), purchase optional cam shifters DCNP-200-KR (for drawers) or DCNP-200-KDR (for doors). **Optional cams and accessories:** See chart below. **Packed 10 per box.**

Item	Finish	Cyl. Length	Pinning	Pin Tumbler Keying	Weight	Price Each
DCN1	26D, US3	1-1/16"	4 pin	KD, KA 101,103,107,915,51001,51002,51003,51004	2.6 lbs/box	\$30.67
DCN1	26D, US3	1-1/16"	5 pin	Stock master keyed or non stock KD, KA	2.6 lbs/box	\$34.69
DCN2	26D, US3	1-3/16"	4 pin	KD, KA 101,103,107,915,51001,51002,51003,51004	2.7 lbs/box	\$30.67
DCN2	26D, US3	1-3/16"	5 pin	Stock master keyed or non stock KD, KA	2.7 lbs/box	\$34.69
DCN3	26D, US3	1-7/16"	4 pin	KD, KA 101,103,107,915,51001,51002,51003,51004	2.9 lbs/box	\$30.67
DCN3	26D, US3	1-7/16"	5 pin	Stock master keyed or non stock KD, KA	2.9 lbs/box	\$34.69
DCN4	26D, US3	1-3/4"	4 pin	KD, KA 101,103,107,915,51001,51002,51003,51004	3.2 lbs/box	\$30.67
DCN4	26D, US3	1-3/4"	5 pin	Stock master keyed or non stock KD, KA	3.2 lbs/box	\$34.69
DCN1	US19	1-1/16"	4 pin	KD, KA 101,103,107,915,51001,51002,51003,51004	2.6 lbs/box	\$44.72
DCN1	US19	1-1/16"	5 pin	Stock master keyed or non stock KD, KA	2.6 lbs/box	\$48.51
DCN2	US19	1-3/16"	4 pin	KD, KA 101,103,107,915,51001,51002,51003,51004	2.7 lbs/box	\$44.72
DCN2	US19	1-3/16"	5 pin	Stock master keyed or non stock KD, KA	2.7 lbs/box	\$48.51
DCN3	US19	1-7/16"	4 pin	KD, KA 101,103,107,915,51001,51002,51003,51004	2.9 lbs/box	\$44.72
DCN3	US19	1-7/16"	5 pin	Stock master keyed or non stock KD, KA	2.9 lbs/box	\$48.51
DCN4	US19	1-3/4"	4 pin	KD, KA 101,103,107,915,51001,51002,51003,51004	3.2 lbs/box	\$44.72
DCN4	US19	1-3/4"	5 pin	Stock master keyed or non stock KD, KA	3.2 lbs/box	\$48.51
DCN1	10B	1-1/16"	4 pin	KD, KA 101,103,107,915,51001,51002,51003,51004	2.6 lbs/box	\$49.89
DCN1	10B	1-1/16"	5 pin	Stock master keyed or non stock KD, KA	2.6 lbs/box	\$53.65
DCN2	10B	1-3/16"	4 pin	KD, KA 101,103,107,915,51001,51002,51003,51004	2.7 lbs/box	\$49.89
DCN2	10B	1-3/16"	5 pin	Stock master keyed or non stock KD, KA	2.7 lbs/box	\$53.65
DCN3	10B	1-7/16"	4 pin	KD, KA 101,103,107,915,51001,51002,51003,51004	2.9 lbs/box	\$49.89
DCN3	10B	1-7/16"	5 pin	Stock master keyed or non stock KD, KA	2.9 lbs/box	\$53.65
DCN4	10B	1-3/4"	4 pin	KD, KA 101,103,107,915	3.2 lbs/box	\$49.89
DCN4	10B	1-3/4"	5 pin	Stock master keyed or non stock KD, KA	3.2 lbs/box	\$53.65
<b>Grand master (3-level system), or systems with multiple master keys:</b> Add to the "Stock master keyed or non stock KD, KA" price. Great grand master keyed (4-level system or higher), call factory for price.					<b>Add on price</b>	<b>\$17.64</b>



**WARNING:** This product can expose you to chemicals including chromium, which is known to the State of California to cause cancer and birth defects or other reproductive harm. For more information go to [www.P65Warnings.ca.gov](http://www.P65Warnings.ca.gov).

**Note:** Offset cams are reversible and can be used in either the inbent or outbent position.

Item	Description / Packed Each	Price Each	Item	Description / Packed Each	Price Each
DCNP-HD-875	7/8" long straight cam	\$2.39	DCNP-500-ARP	Anti-rotation plate	\$1.17
DCNP-HD-1	1" long straight cam	\$2.39	DCNP-300-FP	Finger pull	\$2.95
DCNP-100-SC	1-1/4" long straight cam	\$2.39	DCNP-200-KR	Key-retaining shifter (Drawer)	\$2.25
DCNP-100-SC2	1-3/4" long straight cam	\$2.39	DCNP-200-KDR	Key-retaining shifter (Door)	\$2.25
DCNP-100-SC3	1-1/2" long straight cam	\$2.39	T37DC-NP	Number plate ring	\$0.88
DCNP-100-LC	3" long straight cam	\$2.39	DCNP-GW*	Glass washer	\$1.41
DCNP-100-BC	1-1/4" long cam, 5/16" offset	\$2.39	DCNP-SPW	Pronged wood washer	\$1.06
DCNP-100-BC5	1-1/4" long cam, 1/2" offset	\$2.39	P95-SPW	Eyelet spur washer (NEW)	\$1.07
DCNP-100-HC1	1-1/2" long hook cam, 5/16" offset	\$2.39	TRB7-18-26D	1/8" spacer collar, 26D	\$4.14
DCNP-100-HD	1-7/16" long cam, 1/2" offset	\$2.39	TRB7-14-26D	1/4" spacer collar, 26D	\$5.13
DCNP-100-HD2	1-3/4" long cam, 5/16" offset	\$2.39	TRB7-12-26D	1/2" spacer collar, 26D	\$5.96
DCNP-100-HD3	1-1/8" long cam, 5/16" offset	\$2.39	*DCNP-GW is a plastic washer with a peel-and-stick adhesive back used for mounting DCN on glass.		
DCNP-100-LBC	1-1/2" long cam, 5/16" offset	\$2.39	<b>The following warning is applicable to all parts listed on this page:</b>		
DCNP-100-B1	Straight cam with oval cutout	\$2.39	<b>WARNING:</b> This product can expose you to chemicals including chromium, which is known to the State of California to cause cancer and birth defects or other reproductive harm. For more information go to <a href="http://www.P65Warnings.ca.gov">www.P65Warnings.ca.gov</a> .		
DCNP-100-B2	U-shaped cam	\$2.39			
DCNP-100-B3	Straight hook cam	\$2.39			
DCNP-100-WB	Short cam / 90° offset arm	\$2.39			

# N SERIES Key together with other N Series Locks

## 300SD Sliding Door Push Lock



Standard function: Key removable in locked or unlocked position. Packed 10 per box.

Item	Finish	Fits Material	Pinning	Pin Tumbler Keying	Weight	Price Each	
300SD	26D, US3	1"	4 pin	KD, KA 101,103,107,915	2.9 lbs/box	\$59.57	
300SD	26D, US3	1"	5 pin	Stock master keyed or non stock KD, KA	2.9 lbs/box	\$64.04	
300SD	10B	1"	4 pin	KD, KA 101,103,107,915	2.9 lbs/box	\$78.00	
300SD	10B	1"	5 pin	Stock master keyed or non stock KD, KA	2.9 lbs/box	\$82.06	
Grand master (3-level system), or systems with multiple master keys: Add to the "Stock master keyed or non stock KD, KA" price. Great grand master keyed (4-level system or higher), call factory for price.						Add on price	\$17.64



**WARNING:** This product can expose you to chemicals including chromium, which is known to the State of California to cause cancer and birth defects or other reproductive harm. For more information go to [www.P65Warnings.ca.gov](http://www.P65Warnings.ca.gov).

## 329R Showcase/Ratchet Lock



Standard function: Key removable in locked or unlocked position. Packed 10 per box.

Item	Finish	Fits Material	Pinning	Pin Tumbler Keying	Weight	Price Each	
329R	26D	For 1/4" panels	4 pin	KD, KA 101,103,107,915	5.3 lbs/box	\$57.28	
329R	26D	For 1/4" panels	5 pin	Stock master keyed or non stock KD, KA	5.3 lbs/box	\$61.57	
Grand master (3-level system), or systems with multiple master keys: Add to the "Stock master keyed or non stock KD, KA" price. Great grand master keyed (4-level system or higher), call factory for price.						Add on price	\$17.64



**WARNING:** This product can expose you to chemicals including chromium, which is known to the State of California to cause cancer and birth defects or other reproductive harm. For more information go to [www.P65Warnings.ca.gov](http://www.P65Warnings.ca.gov).

## T37 T-Bolt Lock



Standard function: Key removable in locked or unlocked position. Includes: brass fixing nut and standard bolt. Packed 10 per box.

Item	Finish	Fits Mat.	Pinning	Pin Tumbler Keying	Weight	Price Each
T37	26D	1/4"	4 pin	KD, KA 101,103,107,915	2.1 lbs/box	\$37.27
T37	26D	1/4"	4 pin	KA 51001 through 51011, KA 001 through 030	2.1 lbs/box	\$37.27
T37	26D	1/4"	4 pin	Stock master keyed or non stock KD, KA	2.1 lbs/box	\$41.34

Grand master keying not available.

Item	Description	Packed	Price Each
T37-1	Standard bolt (requires bolt spring sold separately)	Packed Each	\$10.17
T37-2	Optional long bolt (requires bolt spring sold separately)	Packed Each	\$16.69
T37-3	Optional short bolt (requires bolt spring sold separately)	Packed Each	\$10.17
T37-RC	Optional spring mounting clip (for 0" to 11/64" material thickness)	Packed Each	\$1.76
T37-SP	Replacement bolt spring	Packed Each	\$0.55
T37-TS	Replacement top slide / pin cover	Packed Each	\$0.94
T37-TR	Replacement trim collar (standard)	Packed Each	\$3.33
T37-NKIT	Number plate kit for T37 (Includes below 2 items)	Packed Each	\$4.19
T37DC-NP	Number plate only	Packed Each	\$0.88
T37-TR2	Trim collar for use with number plates	Packed Each	\$3.33



**WARNING:** This product can expose you to chemicals including chromium, which is known to the State of California to cause cancer and birth defects or other reproductive harm. For more information go to [www.P65Warnings.ca.gov](http://www.P65Warnings.ca.gov).

## T54C T-Knob Cylinder Replacement Kit



Replacement cylinder for use in CompX/National pin tumbler T-Knob locks (C8154 / C8155).



**Standard:** T54C ships standard with 2 ringed 4-pin National D4291 keyblanks (our KBN-4-NP). Does not include pins or springs. 5-pin keyblanks are available separately (KBN-5-NP). Custom keyed upon request.  
**Note:** Olympus does not sell T-knob locks, only the replacement cylinders. The T54C will work with all C8154/C8155 T-knob locks regardless of handing or key operation. Packed 25 per box.

Item	Finish	Pinning	Pin Tumbler Keying	Weight	Price Each
T54C	26D	n/a	No pins or springs / drilled for 5 pins	2.4 lbs/box	\$23.38
T54C	26D	4 or 5 pin	Stock master keyed or non stock KD, KA	2.4 lbs/box	\$29.21

Grand master keying not available.



**WARNING:** This product can expose you to chemicals including chromium, which is known to the State of California to cause cancer and birth defects or other reproductive harm. For more information go to [www.P65Warnings.ca.gov](http://www.P65Warnings.ca.gov).

# N SERIES Key together with other N Series Locks

## L20V Drawer Latch Lock



**Standard function:** Spring latch. For cabinet doors, place lock on side. **Packed 10 per box.**

Item	Finish	Cyl. Length	Pinning	Pin Tumbler Keying	Weight	Price Each	
L20V	26D	7/8"	4 pin	KD, KA 101,103,107,915	4.9 lbs/box	\$64.62	
L20V	26D	7/8"	5 pin	Stock master keyed or non stock KD, KA	4.9 lbs/box	\$68.84	
L20V	26D	1-3/8"	4 pin	KD, KA 101,103,107,915	5.7 lbs/box	\$64.62	
L20V	26D	1-3/8"	5 pin	Stock master keyed or non stock KD, KA	5.7 lbs/box	\$68.84	
<b>Grand master (3-level system), or systems with multiple master keys:</b> Add to the "Stock master keyed or non stock KD, KA" price. Great grand master keyed (4-level system or higher), call factory for price.						<b>Add on price</b>	<b>\$17.64</b>



**WARNING:** This product can expose you to chemicals including chromium, which is known to the State of California to cause cancer and birth defects or other reproductive harm. For more information go to [www.P65Warnings.ca.gov](http://www.P65Warnings.ca.gov).

## 999 Door Latch Lock



999R



999L

**Standard function:** Spring latch. **Field reversible:** Can be reconfigured into all four handings (LH, RH, VH or IH). **Handing:** See the handing chart on page 5 for proper handing of locks. **Packed 10 per box.**

Item	Handing	Finish	Fits Mat.	Pinning	Pin Tumbler Keying	Weight	Price Each
999R	RH	26D, US4	7/8"	4 pin	KD, KA 101,103,107,915	5.0 lbs/box	\$64.62
999R	RH	26D, US4	7/8"	5 pin	Stock master keyed or non stock KD, KA	5.0 lbs/box	\$68.84
999R	RH	26D, US4	1-3/8"	4 pin	KD, KA 101,103,107,915	5.7 lbs/box	\$64.62
999R	RH	26D, US4	1-3/8"	5 pin	Stock master keyed or non stock KD, KA	5.7 lbs/box	\$68.84
999L	LH	26D, US4	7/8"	4 pin	KD, KA 101,103,107,915	5.0 lbs/box	\$64.62
999L	LH	26D, US4	7/8"	5 pin	Stock master keyed or non stock KD, KA	5.0 lbs/box	\$68.84
999L	LH	26D, US4	1-3/8"	4 pin	KD, KA 101,103,107,915	5.7 lbs/box	\$64.62
999L	LH	26D, US4	1-3/8"	5 pin	Stock master keyed or non stock KD, KA	5.7 lbs/box	\$68.84
<b>Grand master (3-level system) or systems with multiple master keys:</b> Add to the "Stock master keyed or non stock KD, KA" price. Great grand master keyed (4-level system or higher), call factory for price.						<b>Add on price</b>	<b>\$17.64</b>



**WARNING:** This product can expose you to chemicals including chromium, which is known to the State of California to cause cancer and birth defects or other reproductive harm. For more information go to [www.P65Warnings.ca.gov](http://www.P65Warnings.ca.gov).

## 998 Drawer Latch Lock



998V



998I

**Standard function:** Spring latch. **Field reversible:** Can be reconfigured into all four handings (LH, RH, VH or IH). **Handing:** See the handing chart on page 5 for proper handing of locks. **Packed 10 per box.**

Item	Handing	Finish	Fits Mat.	Pinning	Pin Tumbler Keying	Weight	Price Each
998V	VH	26D, US4	7/8"	4 pin	KD, KA 101,103,107,915	5.0 lbs/box	\$64.62
998V	VH	26D, US4	7/8"	5 pin	Stock master keyed or non stock KD, KA	5.0 lbs/box	\$68.84
998V	VH	26D, US4	1-3/8"	4 pin	KD, KA 101,103,107,915	5.7 lbs/box	\$64.62
998V	VH	26D, US4	1-3/8"	5 pin	Stock master keyed or non stock KD, KA	5.7 lbs/box	\$68.84
998I	IH	26D, US4	7/8"	4 pin	KD, KA 101,103,107,915	5.0 lbs/box	\$64.62
998I	IH	26D, US4	7/8"	5 pin	Stock master keyed or non stock KD, KA	5.0 lbs/box	\$68.84
998I	IH	26D, US4	1-3/8"	4 pin	KD, KA 101,103,107,915	5.7 lbs/box	\$64.62
998I	IH	26D, US4	1-3/8"	5 pin	Stock master keyed or non stock KD, KA	5.7 lbs/box	\$68.84
<b>Grand master (3-level system) or systems with multiple master keys:</b> Add to the "Stock master keyed or non stock KD, KA" price. Great grand master keyed (4-level system or higher), call factory for price.						<b>Add on price</b>	<b>\$17.64</b>



**WARNING:** This product can expose you to chemicals including chromium, which is known to the State of California to cause cancer and birth defects or other reproductive harm. For more information go to [www.P65Warnings.ca.gov](http://www.P65Warnings.ca.gov).

# N SERIES Key together with other N Series Locks

## FC10 File Cabinet Lock Kit



FC10



FC26-AR

**Standard function:** Direct replacement for HON F24/F28 style file cabinet lock. Includes all parts necessary for complete lock replacement. Use the optional FC26-AR adapter with the standard FC10 file cabinet lock kit for replacement of HON F26 style file cabinet lock. Packed 10 per box.

Item	Finish	Fits	Pinning	Pin Tumbler Keying	Weight	Price Each
FC10	26D	HON vertical file cabinets*	4 pin	KD, KA 101,103,107,915	2.5 lbs/box	\$41.87
FC10	26D	HON vertical file cabinets*	5 pin	Stock master keyed or non stock KD, KA	2.5 lbs/box	\$46.16
<b>Grand master (3-level system) or systems with multiple master keys:</b> Add to the "Stock master keyed or non stock KD, KA" price. Great grand master keyed (4-level system or higher), call factory for price.					<b>Add on price</b>	<b>\$17.64</b>

Item	Finish	Fits	Description	Price Each
FC26-AR	26D	HON vertical file cabinets*	Adapter ring allows use of FC10 file cabinet lock kit in HON F26 style applications	\$6.18



**WARNING:** This product can expose you to chemicals including chromium, which is known to the State of California to cause cancer and birth defects or other reproductive harm. For more information go to [www.P65Warnings.ca.gov](http://www.P65Warnings.ca.gov).

## N078 Diamond Back Drawer Lock



**Standard function:** Key removable in locked or unlocked position. Packed 10 per box.

Item	Handing	Finish	Fits Mat.	Pinning	Pin Tumbler Keying	Weight	Price Each
N078	VH	26D, US4	1-1/8"	4 pin	KD, KA 101,103,107,915	3.1 lbs/box	\$35.10
N078	VH	26D, US4	1-1/8"	5 pin	Stock master keyed or non stock KD, KA	3.1 lbs/box	\$39.33
N078	VH	26D, US4	1-3/8"	4 pin	KD, KA 101,103,107,915	3.6 lbs/box	\$38.33
N078	VH	26D, US4	1-3/8"	5 pin	Stock master keyed or non stock KD, KA	3.6 lbs/box	\$42.60
<b>Grand master (3-level system) or systems with multiple master keys:</b> Add to the "Stock master keyed or non stock KD, KA" price. Great grand master keyed (4-level system or higher), call factory for price.					<b>Add on price</b>	<b>\$17.64</b>	
<b>Optional bolt:</b> Add this charge to the above prices for factory installed optional bolt 078-LB1-DW					<b>Add on price</b>	<b>\$9.36</b>	

Item	Description	Packed	Price Each
078-LB1-DW	Optional 1/2" outbent long bolt for N078/R078 drawer locks (bolt only)	Packed Each	\$5.53



**WARNING:** This product can expose you to chemicals including chromium, which is known to the State of California to cause cancer and birth defects or other reproductive harm. For more information go to [www.P65Warnings.ca.gov](http://www.P65Warnings.ca.gov).

## N078 Diamond Back Door Lock



N078R



N078L

**Standard function:** Key removable in locked or unlocked position. See the handing chart on page 5 for proper handing of locks (left-hand or right-hand). Packed 10 per box.

Item	Handing	Finish	Fits Mat.	Pinning	Pin Tumbler Keying	Weight	Price Each
N078R	RH	26D	1-1/8"	4 pin	KD, KA 101,103,107,915	3.1 lbs/box	\$35.10
N078R	RH	26D	1-1/8"	5 pin	Stock master keyed or non stock KD, KA	3.1 lbs/box	\$39.33
N078R	RH	26D	1-3/8"	4 pin	KD, KA 101,103,107,915	3.6 lbs/box	\$38.33
N078R	RH	26D	1-3/8"	5 pin	Stock master keyed or non stock KD, KA	3.6 lbs/box	\$42.60
N078L	LH	26D	1-1/8"	4 pin	KD, KA 101,103,107,915	3.1 lbs/box	\$35.10
N078L	LH	26D	1-1/8"	5 pin	Stock master keyed or non stock KD, KA	3.1 lbs/box	\$39.33
N078L	LH	26D	1-3/8"	4 pin	KD, KA 101,103,107,915	3.6 lbs/box	\$38.33
N078L	LH	26D	1-3/8"	5 pin	Stock master keyed or non stock KD, KA	3.6 lbs/box	\$42.60

<b>Grand master (3-level system) or systems with multiple master keys:</b> Add to the "Stock master keyed or non stock KD, KA" price. Great grand master keyed (4-level system or higher), call factory for price.					<b>Add on price</b>	<b>\$17.54</b>
<b>Optional bolt:</b> Add this charge to the above prices for factory installed optional bolt 078-LB-DR					<b>Add on price</b>	<b>\$9.36</b>

Item	Description	Packed	Price Each
078-LB-DR	Optional 1/4" longer bolt for N078 door locks (bolt only)	Packed Each	\$3.10



**WARNING:** This product can expose you to chemicals including chromium, which is known to the State of California to cause cancer and birth defects or other reproductive harm. For more information go to [www.P65Warnings.ca.gov](http://www.P65Warnings.ca.gov).

# R SERIES Key together with other R Series Locks

**Keyway:** CCL R1 Keyway (5-pin), 6-pin keying available  
**KD/KA:** 5 pin standard  
**Stock KA Nos.** 4T21579, 4T37526  
**Stock master keyed:** 5 pin standard  
**Pin Kit:** Use R1 Pin Kit for rekeying

**Keyblanks:** 5-pin use KBR-5-NP (equivalent to CO106, 1003A), 6-pin use KBR-6 (equivalent to L1003A). See page 40 for cut keys and keyblanks.  
**Accessories:** Additional accessories are available for these products. See the accessories section or consult factory.

**Custom stamping:** See page 40.  
**Keying information:** See page 6.

## 500DR / 500B Door Deadbolt Lock



ANSI/BHMA A156.11  
 Grade 1, E07121

Woodwork Institute (WI)  
 acknowledged product

**Standard function:** Key removable in locked or unlocked position. Standard locks are non-handed. **Key-retaining:** For key removable in locked position only, specify the key-retaining part-numbers. See handing chart on page 5 for proper handing of locks (left or right).  
**Packed 10 per box.**

Item	Finish	Fits Material	Pinning	Pin Tumbler Keying	Weight	Price Each	
500DR	26D, US4	7/8"	5 pin	KD, KA 4T21579, 4T37526	4.8 lbs/box	\$48.53	
500DR	26D, US4	7/8"	5 pin	Stock master keyed or non stock KD, KA	4.8 lbs/box	\$54.00	
500DR	26D, US4	1-3/8"	5 pin	KD, KA 4T21579, 4T37526	5.6 lbs/box	\$48.53	
500DR	26D, US4	1-3/8"	5 pin	Stock master keyed or non stock KD, KA	5.6 lbs/box	\$54.00	
500DR	10B	7/8"	5 pin	KD, KA 4T21579, 4T37526	4.8 lbs/box	\$72.05	
500DR	10B	7/8"	5 pin	Stock master keyed or non stock KD, KA	4.8 lbs/box	\$77.04	
<b>Key-retaining:</b> Specify item <b>500KL</b> for left-hand doors and <b>500KR</b> for right-hand doors. (KL and KR designation are only required for key retaining locks). Standard locks are non-handed.						<b>Add on price</b>	<b>\$7.76</b>
<b>Grand master (3-level system), systems with multiple master keys, or 6 pin keying:</b> Add to the "Stock master keyed or non stock KD, KA" price. Great grand master keyed (4-level system or higher), call factory for price.						<b>Add on price</b>	<b>\$17.64</b>
<b>500B</b>	<b>Weather resistant:</b> Includes weather resistant components. Suitable for outdoor use in <u>covered areas only</u> . Specify <b>500B</b> series. Include finish, barrel length and keying.					<b>Add on price</b>	<b>\$9.36</b>
<b>Long bolt:</b> For long bolt #15-1-35 factory installed in lock (specify <b>-LB</b> option). Bolts available separately for <b>\$12.65</b> list price each. Extends bolt projection to 1-1/2".						<b>Add on price</b>	<b>\$20.06</b>



**WARNING:** This product can expose you to chemicals including chromium, which is known to the State of California to cause cancer and birth defects or other reproductive harm. For more information go to [www.P65Warnings.ca.gov](http://www.P65Warnings.ca.gov).

## 500M Door Deadbolt Lock (MRI Series)



ANSI/BHMA A156.11  
 Grade 1, E07121

Woodwork Institute (WI)  
 acknowledged product

**500M MRI Series:** Include all non-ferrous (non-magnetic) metals and materials and are suitable for use in medical applications including Magnetic Resonance Imaging (MRI) suites due to their non-magnetic properties. **Standard function:** Key removable in locked or unlocked position. Standard locks are non-handed. **Key-retaining:** For key removable in locked position only, specify the key-retaining part-numbers. See handing chart on page 5 for proper handing of locks (left or right). **Keys:** Includes copper plated non-magnetic keys (KBR-5B).  
**Packed 10 per box.**

Item	Finish	Fits Material	Pinning	Pin Tumbler Keying	Weight	Price Each	
500M	26D	7/8"	5 pin	KD, KA 4T21579, 4T37526	4.8 lbs/box	\$61.89	
500M	26D	7/8"	5 pin	Stock master keyed or non stock KD, KA	4.8 lbs/box	\$67.37	
500M	26D	1-3/8"	5 pin	KD, KA 4T21579, 4T37526	5.6 lbs/box	\$61.89	
500M	26D	1-3/8"	5 pin	Stock master keyed or non stock KD, KA	5.6 lbs/box	\$67.37	
<b>Key-retaining:</b> Specify item <b>500MKL</b> for left-hand doors and <b>500MKR</b> for right-hand doors. (MKL and MKR designation are only required for key retaining locks). Standard locks are non-handed.						<b>Add on price</b>	<b>\$7.76</b>
<b>Grand master (3-level system), systems with multiple master keys, or 6 pin keying:</b> Add to the "Stock master keyed or non stock KD, KA" price. Great grand master keyed (4-level system or higher), call factory for price.						<b>Add on price</b>	<b>\$17.64</b>
<b>Long bolt:</b> For long bolt #15-1-35 factory installed in lock (specify <b>-LB</b> option). Bolts available separately for <b>\$12.65</b> list price each. Extends bolt projection to 1-1/2".						<b>Add on price</b>	<b>\$20.06</b>



**WARNING:** This product can expose you to chemicals including chromium, which is known to the State of California to cause cancer and birth defects or other reproductive harm. For more information go to [www.P65Warnings.ca.gov](http://www.P65Warnings.ca.gov).

# R SERIES Key together with other R Series Locks

## 600DW / 600B Drawer Deadbolt Lock



ANSI/BHMA A156.11  
Grade 1, E07041  
Woodwork Institute (WI)  
acknowledged product

**Standard function:** Key removable in locked or unlocked position. Standard locks are non-handed. **Key-retaining:** For key removable in locked position only, specify the key-retaining part-numbers. See the handing chart on page 5 for proper handing of locks (vertical or inverted).  
**Packed 10 per box.**

Item	Finish	Fits Material	Pinning	Pin Tumbler Keying	Weight	Price Each	
600DW	26D, US4	7/8"	5 pin	KD, KA 4T21579, 4T37526	4.8 lbs/box	\$48.53	
600DW	26D, US4	7/8"	5 pin	Stock master keyed or non stock KD, KA	4.8 lbs/box	\$54.00	
600DW	26D, US4	1-3/8"	5 pin	KD, KA 4T21579, 4T37526	5.6 lbs/box	\$48.53	
600DW	26D, US4	1-3/8"	5 pin	Stock master keyed or non stock KD, KA	5.6 lbs/box	\$54.00	
600DW	10B	7/8"	5 pin	KD, KA 4T21579, 4T37526	4.8 lbs/box	\$72.05	
600DW	10B	7/8"	5 pin	Stock master keyed or non stock KD, KA	4.8 lbs/box	\$77.04	
600DW	10B	1-3/8"	5 pin	KD, KA 4T21579, 4T37526	5.6 lbs/box	\$72.05	
600DW	10B	1-3/8"	5 pin	Stock master keyed or non stock KD, KA	5.6 lbs/box	\$77.04	
<b>Key-retaining:</b> Specify item <b>600KI</b> for inverted drawers and <b>600KV</b> for vertical drawers. (KI and KV designations are only required for key retaining locks). Standard locks are non-handed.					Add on price	\$7.76	
<b>Grand master (3-level system), systems with multiple master keys, or 6 pin keying:</b> Add to the "Stock master keyed or non stock KD, KA" price. Great grand master keyed (4-level system or higher), call factory for price.					Add on price	\$17.64	
<b>600B</b>	<b>Weather resistant:</b> Includes weather resistant components. Suitable for outdoor use in <u>covered areas only</u> . Specify <b>600B</b> series. Include finish, barrel length and keying.					Add on price	\$9.36
<b>Long bolt:</b> For long bolt #15-1-35 factory installed in lock (specify <b>-LB</b> option). Bolts available separately for \$12.65 list price each. Extends bolt projection to approximately 1-1/2".					Add on price	\$20.06	



**WARNING:** This product can expose you to chemicals including chromium, which is known to the State of California to cause cancer and birth defects or other reproductive harm. For more information go to [www.P65Warnings.ca.gov](http://www.P65Warnings.ca.gov).

## 600M Drawer Deadbolt Lock (MRI Series)



ANSI/BHMA A156.11  
Grade 1, E07041  
Woodwork Institute (WI)  
acknowledged product

**600M MRI Series:** Include all non-ferrous (non-magnetic) metals and materials and are suitable for use in medical applications including Magnetic Resonance Imaging (MRI) suites due to their non-magnetic properties. **Standard function:** Key removable in locked or unlocked position. Standard locks are non-handed. **Key-retaining:** For key removable in locked position only, specify the key-retaining part-numbers. See the handing chart on page 5 for proper handing of locks (vertical or inverted). **Keys:** Includes copper plated non-magnetic keys (KBR-5B).  
**Packed 10 per box.**

Item	Finish	Fits Material	Pinning	Pin Tumbler Keying	Weight	Price Each
600M	26D	7/8"	5 pin	KD, KA 4T21579, 4T37526	4.8 lbs/box	\$61.89
600M	26D	7/8"	5 pin	Stock master keyed or non stock KD, KA	4.8 lbs/box	\$67.37
600M	26D	1-3/8"	5 pin	KD, KA 4T21579, 4T37526	5.6 lbs/box	\$61.89
600M	26D	1-3/8"	5 pin	Stock master keyed or non stock KD, KA	5.6 lbs/box	\$67.37
<b>Key-retaining:</b> Specify item <b>600MKI</b> for inverted drawers and <b>600MKV</b> for vertical drawers. (MKI and MKV designations are only required for key retaining locks). Standard locks are non-handed.					Add on price	\$7.76
<b>Grand master (3-level system), systems with multiple master keys, or 6 pin keying:</b> Add to the "Stock master keyed or non stock KD, KA" price. Great grand master keyed (4-level system or higher), call factory for price.					Add on price	\$17.64
<b>Long bolt:</b> For long bolt #15-1-35 factory installed in lock (specify <b>-LB</b> option). Bolts available separately for \$12.65 list price each. Extends bolt projection to approximately 1-1/2".					Add on price	\$20.06



**WARNING:** This product can expose you to chemicals including chromium, which is known to the State of California to cause cancer and birth defects or other reproductive harm. For more information go to [www.P65Warnings.ca.gov](http://www.P65Warnings.ca.gov).

## 400SD Sliding Door Push Lock



**Standard function:** Key removable in locked or unlocked position. **Packed 10 per box.**

Item	Finish	Fits Material	Pinning	Pin Tumbler Keying	Weight	Price Each
400SD	26D, US3	1"	5 pin	KD, KA 4T21579, 4T37526	2.9 lbs/box	\$60.68
400SD	26D, US3	1"	5 pin	Stock master keyed or non stock KD, KA	2.9 lbs/box	\$64.68
400SD	10B	1"	5 pin	KD, KA 4T21579, 4T37526	2.9 lbs/box	\$81.76
400SD	10B	1"	5 pin	Stock master keyed or non stock KD, KA	2.9 lbs/box	\$86.76
<b>Grand master (3-level system) or systems with multiple master keys:</b> Add to the "Stock master keyed or non stock KD, KA" price. Great grand master keyed (4-level system or higher), call factory for price.					Add on price	\$20.06



**WARNING:** This product can expose you to chemicals including chromium, which is known to the State of California to cause cancer and birth defects or other reproductive harm. For more information go to [www.P65Warnings.ca.gov](http://www.P65Warnings.ca.gov).

# R SERIES Key together with other R Series Locks

## 429R Showcase/Ratchet Lock



**Standard function:** Key removable in locked or unlocked position. **Packed 10 per box.**

Item	Finish	Fits Material	Pinning	Pin Tumbler Keying	Weight	Price Each
429R	26D	For 1/4" panels	5 pin	KD, KA 4T21579, 4T37526	5.3 lbs/box	\$59.21
429R	26D	For 1/4" panels	5 pin	Stock master keyed or non stock KD, KA	5.3 lbs/box	\$64.68
<b>Grand master (3-level system) or systems with multiple master keys:</b> Add to the "Stock master keyed or non stock KD, KA" price. Great grand master keyed (4-level system or higher), call factory for price.					<b>Add on price</b>	<b>\$17.64</b>



**WARNING:** This product can expose you to chemicals including chromium, which is known to the State of California to cause cancer and birth defects or other reproductive harm. For more information go to [www.P65Warnings.ca.gov](http://www.P65Warnings.ca.gov).

## DCR Cam Lock



ANSI/BHMA A156.11  
Grade 1  
E07261 / E07271

Woodwork Institute (WI)  
acknowledged products

**Standard function:** Key removable in locked or unlocked position. Ships with DCNP-500-ARP (anti-rotation plate), DCNP-100-SC (straight cam) and DCNP-100-BC (reversible offset cam). **Key-retaining:** For key removable in locked position only, purchase optional cam shifters DCNP-200-KR (for drawers) or DCNP-200-KDR (for doors). **Optional cams and accessories:** See chart below. **Packed 10 per box.**

Item	Finish	Cyl. Length	Pinning	Pin Tumbler Keying	Weight	Price Each
DCR1	26D, US3	1-1/16"	5 pin	KD, KA 4T21579, 4T37526	2.6 lbs/box	\$36.11
DCR1	26D, US3	1-1/16"	5 pin	Stock master keyed or non stock KD, KA	2.6 lbs/box	\$41.58
DCR2	26D, US3	1-3/16"	5 pin	KD, KA 4T21579, 4T37526	2.7 lbs/box	\$36.11
DCR2	26D, US3	1-3/16"	5 pin	Stock master keyed or non stock KD, KA	2.7 lbs/box	\$41.58
DCR3	26D, US3	1-7/16"	5 pin	KD, KA 4T21579, 4T37526	2.9 lbs/box	\$36.11
DCR3	26D, US3	1-7/16"	5 pin	Stock master keyed or non stock KD, KA	2.9 lbs/box	\$41.58
DCR4	26D, US3	1-3/4"	5 pin	KD, KA 4T21579, 4T37526	3.2 lbs/box	\$36.11
DCR4	26D, US3	1-3/4"	5 pin	Stock master keyed or non stock KD, KA	3.2 lbs/box	\$41.58
<b>Grand master (3-level system) or systems with multiple master keys:</b> Add to the "Stock master keyed or non stock KD, KA" price. Great grand master keyed (4-level system or higher), call factory for price.					<b>Add on price</b>	<b>\$17.64</b>

**Note:** Offset cams are reversible and can be used in either the inbent or outbent position.

Item	Description / Packed Each	Price Each	Item	Description / Packed Each	Price Each
DCNP-HD-875	7/8" long straight cam	\$2.39	DCNP-500-ARP	Anti-rotation plate	\$1.17
DCNP-HD-1	1" long straight cam	\$2.39	DCNP-300-FP	Finger pull	\$2.95
DCNP-100-SC	1-1/4" long straight cam	\$2.39	DCNP-200-KR	Key-retaining shifter (Drawer)	\$2.25
DCNP-100-SC2	1-3/4" long straight cam	\$2.39	DCNP-200-KDR	Key-retaining shifter (Door)	\$2.25
DCNP-100-SC3	1-1/2" long straight cam	\$2.39	T37DC-NP	Number plate ring	\$0.88
DCNP-100-LC	3" long straight cam	\$2.39	DCNP-GW*	Glass washer	\$1.41
DCNP-100-BC	1-1/4" long cam, 5/16" offset	\$2.39	DCNP-SPW	Pronged wood washer	\$1.06
DCNP-100-BC5	1-1/4" long cam, 1/2" offset	\$2.39	P95-SPW	Eyelet spur washer	\$1.07
DCNP-100-HC1	1-1/2" long hook cam, 5/16" offset	\$2.39	TRB7-18-26D	1/8" spacer collar, 26D	\$4.14
DCNP-100-HD	1-7/16" long cam, 1/2" offset	\$2.39	TRB7-14-26D	1/4" spacer collar, 26D	\$5.13
DCNP-100-HD2	1-3/4" long cam, 5/16" offset	\$2.39	TRB7-12-26D	1/2" spacer collar, 26D	\$5.96
DCNP-100-HD3	1-1/8" long cam, 5/16" offset	\$2.39	*DCNP-GW is a plastic washer with a peel-and-stick adhesive back used for mounting DCN on glass.		
DCNP-100-LBC	1-1/2" long cam, 5/16" offset	\$2.39			
DCNP-100-B1	Straight cam with oval cutout	\$2.39			
DCNP-100-B2	U-shaped cam	\$2.39			
DCNP-100-B3	Straight hook cam	\$2.39			
DCNP-100-WB	Short cam / 90° offset arm	\$2.39			

The following warning is applicable to all parts listed on this page:



**WARNING:** This product can expose you to chemicals including chromium, which is known to the State of California to cause cancer and birth defects or other reproductive harm. For more information go to [www.P65Warnings.ca.gov](http://www.P65Warnings.ca.gov).

# R SERIES Key together with other R Series Locks

## R078 Diamond Back Drawer Lock

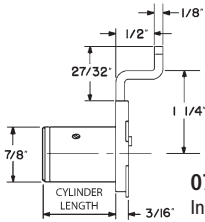

**078-LB1-DW**  
Installed Dimensions

Standard function: Key removable in locked or unlocked position. Packed 10 per box.

Item	Finish	Fits Mat.	Pinning	Pin Tumbler Keying	Weight	Price Each
R078	26D, US4	1-1/8"	5 pin	KD, KA 4T21579, 4T37526	3.1 lbs/box	\$36.67
R078	26D, US4	1-1/8"	5 pin	Stock master keyed or non stock KD, KA	3.1 lbs/box	\$42.15
<b>Grand master (3-level system) or systems with multiple master keys:</b> Add to the "Stock master keyed or non stock KD, KA" price. Great grand master keyed (4-level system or higher), call factory for price.					<b>Add on price</b>	<b>\$17.64</b>
<b>Optional bolt:</b> Add this charge to the above prices for factory installed optional bolt 078-LB1-DW					<b>Add on price</b>	<b>\$9.36</b>

Item	Description	Packed	Price Each
078-LB1-DW	Optional 1/2" offset long bolt for N078/R078 drawer locks (bolt only)	Packed Each	\$5.53



**WARNING:** This product can expose you to chemicals including chromium, which is known to the State of California to cause cancer and birth defects or other reproductive harm. For more information go to [www.P65Warnings.ca.gov](http://www.P65Warnings.ca.gov).

## 997 Door Latch Lock



997R



997L

Standard function: Spring latch. Field reversible: Can be reconfigured into all four handings (LH, RH, VH or IH). Handing: See the handing chart on page 5 for proper handing of locks. Packed 10 per box.

Item	Handing	Finish	Fits Mat.	Pinning	Pin Tumbler Keying	Weight	Price Each
997R	RH	26D, US4	7/8"	5 pin	KD, KA 4T21579, 4T37526	5.0 lbs/box	\$70.45
997R	RH	26D, US4	7/8"	5 pin	Stock master keyed or non stock KD, KA	5.0 lbs/box	\$75.94
997R	RH	26D, US4	1-3/8"	5 pin	KD, KA 4T21579, 4T37526	5.7 lbs/box	\$70.45
997R	RH	26D, US4	1-3/8"	5 pin	Stock master keyed or non stock KD, KA	5.7 lbs/box	\$75.94
997L	LH	26D, US4	7/8"	5 pin	KD, KA 4T21579, 4T37526	5.0 lbs/box	\$70.45
997L	LH	26D, US4	7/8"	5 pin	Stock master keyed or non stock KD, KA	5.0 lbs/box	\$75.94
999L	LH	26D, US4	1-3/8"	5 pin	KD, KA 4T21579, 4T37526	5.7 lbs/box	\$70.45
999L	LH	26D, US4	1-3/8"	5 pin	Stock master keyed or non stock KD, KA	5.7 lbs/box	\$75.94
<b>Grand master (3-level system), systems with multiple master keys, or 6 pin keying:</b> Add to the "Stock master keyed or non stock KD, KA" price. Great grand master keyed (4-level system or higher), call factory for price.						<b>Add on price</b>	<b>\$17.64</b>



**WARNING:** This product can expose you to chemicals including chromium, which is known to the State of California to cause cancer and birth defects or other reproductive harm. For more information go to [www.P65Warnings.ca.gov](http://www.P65Warnings.ca.gov).

## 996 Drawer Latch Lock



996V



996I

Standard function: Spring latch. Field reversible: Can be reconfigured into all four handings (LH, RH, VH or IH). Handing: See the handing chart on page 5 for proper handing of locks. Packed 10 per box.

Item	Handing	Finish	Fits Mat.	Pinning	Pin Tumbler Keying	Weight	Price Each
996V	VH	26D, US4	7/8"	5 pin	KD, KA 4T21579, 4T37526	5.0 lbs/box	\$70.45
996V	VH	26D, US4	7/8"	5 pin	Stock master keyed or non stock KD, KA	5.0 lbs/box	\$75.94
996V	VH	26D, US4	1-3/8"	5 pin	KD, KA 4T21579, 4T37526	5.7 lbs/box	\$70.45
996V	VH	26D, US4	1-3/8"	5 pin	Stock master keyed or non stock KD, KA	5.7 lbs/box	\$75.94
996I	IH	26D, US4	7/8"	5 pin	KD, KA 4T21579, 4T37526	5.0 lbs/box	\$70.45
996I	IH	26D, US4	7/8"	5 pin	Stock master keyed or non stock KD, KA	5.0 lbs/box	\$75.94
996I	IH	26D, US4	1-3/8"	5 pin	KD, KA 4T21579, 4T37526	5.7 lbs/box	\$70.45
996I	IH	26D, US4	1-3/8"	5 pin	Stock master keyed or non stock KD, KA	5.7 lbs/box	\$75.94
<b>Grand master (3-level system), systems with multiple master keys, or 6 pin keying:</b> Add to the "Stock master keyed or non stock KD, KA" price. Great grand master keyed (4-level system or higher), call factory for price.						<b>Add on price</b>	<b>\$17.64</b>



**WARNING:** This product can expose you to chemicals including chromium, which is known to the State of California to cause cancer and birth defects or other reproductive harm. For more information go to [www.P65Warnings.ca.gov](http://www.P65Warnings.ca.gov).

# S SERIES Schlage C Keyway



**Keyway:** Schlage C keyway  
**Cylinder:** 6 pin solid brass cylinder **Keyblanks:** KBSC-6-NP.  
 See page 43 for cut keys and keyblanks.  
**Stock KD/KA/0-BIT:** 5 pin standard  
**Stock KA Nos.** 101, 102  
**Accessories:** Additional accessories are available for these products. See accessories section or consult factory.

**Master keyed:** 6 pin standard. Includes numeric key code stamped on the change keys. Lock face stamping available separately for an add-on price of \$9.92 list each. (See custom stamping page 40)  
**Custom stamping charges:** See page 40.  
**Keying information:** See page 6.

## 700S Deadbolt Door Lock



ANSI/BHMA A156.11  
 Grade 1, E07121  
 Woodwork Institute (WI)  
 acknowledged product

**Standard function:** Key removable in locked or unlocked position. Standard locks are non-handed. **Key-retaining:** For key removable in locked position only, specify the key-retaining part-numbers. **Handing:** See handing chart on page 5 for proper handing of locks. **Packed 10 per box.**

Item	Finish	Fits Material	Pinning	Pin Tumbler Keying	Weight	Price Each
700S	26D, US3	1-1/8"	5 pin	KD, KA 101, 102, 0-BIT	7.4 lbs/box	\$79.20
700S	26D, US3	1-1/8"	6 pin	Stock master keyed or non stock KD, KA	7.4 lbs/box	\$88.19
700S	26D, US3	1-3/8"	5 pin	KD, KA 101, 102, 0-BIT	7.4 lbs/box	\$81.23
700S	26D, US3	1-3/8"	6 pin	Stock master keyed or non stock KD, KA	7.4 lbs/box	\$90.20
700S	10B	1-1/8"	5 pin	KD, KA 101, 102, 0-BIT	7.4 lbs/box	\$89.67
700S	10B	1-1/8"	6 pin	Stock master keyed or non stock KD, KA	7.4 lbs/box	\$97.22
700S	10B	1-3/8"	5 pin	KD, KA 101, 102, 0-BIT	7.4 lbs/box	\$91.37
700S	10B	1-3/8"	6 pin	Stock master keyed or non stock KD, KA	7.4 lbs/box	\$98.90

**Key-retaining:** Specify item **700KL** for left-hand doors and **700KR** for right-hand doors. (KL and KR designation are only required for key retaining locks). Standard locks are non-handed. **Add on price \$7.76**

**Grand master (3-level system) or systems with multiple master keys:** Add to the "Stock master keyed or non stock KD, KA" price. Great grand master keyed (4-level system or higher), call factory for price. **Add on price \$17.64**

**Lock face stamping** available separately.  
**Add on \$9.92 price each per lock**



**WARNING:** This product can expose you to chemicals including chromium, which is known to the State of California to cause cancer and birth defects or other reproductive harm. For more information go to [www.P65Warnings.ca.gov](http://www.P65Warnings.ca.gov).

## 800S Deadbolt Drawer Lock



ANSI/BHMA A156.11  
 Grade 1, E07041  
 Woodwork Institute (WI)  
 acknowledged product

**Standard function:** Key removable in locked or unlocked position. Standard locks are non-handed. **Key-retaining:** For key removable in locked position only, specify the key-retaining part-numbers. **Handing:** See handing chart on page 5 for proper handing of locks. **Packed 10 per box.**

Item	Finish	Fits Material	Pinning	Pin Tumbler Keying	Weight	Price Each
800S	26D, US3	1-1/8"	5 pin	KD, KA 101, 102, 0-BIT	7.3 lbs/box	\$79.20
800S	26D, US3	1-1/8"	6 pin	Stock master keyed or non stock KD, KA	7.3 lbs/box	\$88.19
800S	26D, US3	1-3/8"	5 pin	KD, KA 101, 102, 0-BIT	7.2 lbs/box	\$81.23
800S	26D, US3	1-3/8"	6 pin	Stock master keyed or non stock KD, KA	7.2 lbs/box	\$90.20
800S	10B	1-1/8"	5 pin	KD, KA 101, 102, 0-BIT	7.3 lbs/box	\$89.67
800S	10B	1-1/8"	6 pin	Stock master keyed or non stock KD, KA	7.3 lbs/box	\$97.22
800S	10B	1-3/8"	5 pin	KD, KA 101, 102, 0-BIT	7.2 lbs/box	\$91.37
800S	10B	1-3/8"	6 pin	Stock master keyed or non stock KD, KA	7.2 lbs/box	\$98.90

**Key-retaining:** Specify item **800KI** for inverted drawers and **800KV** for vertical drawers. (KI and KV designation are only required for key retaining locks). Standard locks are non-handed. **Add on price \$7.76**

**Grand master (3-level system) or systems with multiple master keys:** Add to the "Stock master keyed or non stock KD, KA" price. Great grand master keyed (4-level system or higher), call factory for price. **Add on price \$17.64**

**Lock face stamping** available separately.  
**Add on \$9.92 price each per lock**



**WARNING:** This product can expose you to chemicals including chromium, which is known to the State of California to cause cancer and birth defects or other reproductive harm. For more information go to [www.P65Warnings.ca.gov](http://www.P65Warnings.ca.gov).

## 820S Cam Lock



**Includes:** 720-PL3 (anti-rotation plate), lost-motion and key retaining door/drawer cam shifters, 720-3-1 and 720-3-2 cams. Additional cams available separately. *Due to length of cylinder, installation may require use of trim collar. See page 42 for details.* **Packed 10 per box.**

Item	Finish	Cyl. Length	Pinning	Pin Tumbler Keying	Weight	Price Each
820S	26D, US3	1-23/32"	5 pin	KD, KA 101, 102, 0-BIT	6.3 lbs/box	\$80.91
820S	26D, US3	1-23/32"	6 pin	Stock master keyed or non stock KD, KA	6.3 lbs/box	\$89.89
<b>Grand master (3-level system) or systems with multiple master keys:</b> Add to the "Stock master keyed or non stock KD, KA" price. Great grand master keyed (4-level system or higher), call factory for price.					<b>Add on price</b>	<b>\$17.64</b>

Item	Description	Packed	Price Each
Additional cams	<b>720-3-1, 720-3-2, 720-3-3, 720-3-4, 720-3-5</b>	Packed Each	\$3.46
Trim Collars	<b>TR201 (1/8"), TR202 (1/4"), TR203 (3/8"), TR204 (5/32"), TR200A (Pkg)</b>	Packed Each	See page 37
SW-1	Switch accessory pack	Packed Each	\$13.33
720-PL3	Anti-rotation plate	Packed Each	\$2.77

**Lock face stamping** available separately.  
**Add on \$9.92 price each per lock**



**WARNING:** This product can expose you to chemicals including chromium, which is known to the State of California to cause cancer and birth defects or other reproductive harm. For more information go to [www.P65Warnings.ca.gov](http://www.P65Warnings.ca.gov).

## 829R Showcase/Ratchet Lock



Complies with clause 6.3 (8.2-8.4) of ANSI/BHMA A156.11 ANSI standards

**Standard function:** Key removable in locked or unlocked position. **Includes:** 729RS-1 strap for 1/4" panel thickness. **Packed 10 per box.**

Item	Finish	Fits Material	Pinning	Pin Tumbler Keying	Weight	Price Each
829R	26D	For 1/4" panels	5 pin	KD, KA 101, 102	7.0 lbs/box	\$96.70
829R	26D	For 1/4" panels	6 pin	Stock master keyed or non stock KD, KA	7.0 lbs/box	\$105.65
<b>Grand master keyed (3-level system) or non stock master keyed:</b> Add to the "Stock master keyed or non stock KD, KA" price. Great grand master keyed (4-level system or higher), call factory for price.					<b>Add on price</b>	<b>\$17.64</b>

Item	Description	Packed	Price Each
729RS-2	Optional strap for 3/8" panel thickness	Packed Each	\$11.47
729RS-3	Optional strap for maximum 5/8", minimum 3/8" panel thickness	Packed Each	\$17.35

Lock face stamping available separately  
**Add on \$9.92 price each per lock**



**WARNING:** This product can expose you to chemicals including chromium, which is known to the State of California to cause cancer and birth defects or other reproductive harm. For more information go to [www.P65Warnings.ca.gov](http://www.P65Warnings.ca.gov).

## 850S Deadlatching Drawer Lock



**Standard function:** Spring latch with deadlocking mechanism. Turn lock 90 degrees for door function. **Includes:** Matching lip strike. **Packed 10 per box.**

Item	Finish	Fits Material	Pinning	Pin Tumbler Keying	Weight	Price Each
850S	26D, US3	1-1/8"	5 pin	KD, KA 101, 102	8.3 lbs/box	\$96.53
850S	26D, US3	1-1/8"	6 pin	Stock master keyed or non stock KD, KA	8.3 lbs/box	\$105.51
850S	26D, US3	1-3/8"	5 pin	KD, KA 101, 102	8.3 lbs/box	\$102.12
850S	26D, US3	1-3/8"	6 pin	Stock master keyed or non stock KD, KA	8.3 lbs/box	\$111.10
<b>Grand master (3-level system) or systems with multiple master keys:</b> Add to the "Stock master keyed or non stock KD, KA" price. Great grand master keyed (4-level system or higher), call factory for price.					<b>Add on price</b>	<b>\$17.64</b>

Lock face stamping available separately  
**Add on \$9.92 price each per lock**



**WARNING:** This product can expose you to chemicals including chromium, which is known to the State of California to cause cancer and birth defects or other reproductive harm. For more information go to [www.P65Warnings.ca.gov](http://www.P65Warnings.ca.gov).

## L78 Door Latch Lock



L78R



L78L

**Standard function:** Spring latch. **Reversible:** Locks are field reversible into any of the 4 handings (drawer VH or IH, door LH or RH). **Handing:** See handing chart on page 5 for proper handing of locks. **Packed 10 per box.**

Item	Handing	Finish	Fits Mat.	Pinning	Pin Tumbler Keying	Weight	Price Each
L78R	RH	26D, US3	1-1/8"	5 pin	KD, KA 101, 102	8.6 lbs/box	\$100.26
L78R	RH	26D, US3	1-1/8"	6 pin	Stock master keyed or non stock KD, KA	8.6 lbs/box	\$109.22
L78R	RH	26D, US3	1-3/8"	5 pin	KD, KA 101, 102	9.0 lbs/box	\$102.27
L78R	RH	26D, US3	1-3/8"	6 pin	Stock master keyed or non stock KD, KA	9.0 lbs/box	\$111.24
L78L	LH	26D, US3	1-1/8"	5 pin	KD, KA 101, 102	8.6 lbs/box	\$100.26
L78L	LH	26D, US3	1-1/8"	6 pin	Stock master keyed or non stock KD, KA	8.6 lbs/box	\$109.22
L78L	LH	26D, US3	1-3/8"	5 pin	KD, KA 101, 102	9.0 lbs/box	\$102.27
L78L	LH	26D, US3	1-3/8"	6 pin	Stock master keyed or non stock KD, KA	9.0 lbs/box	\$111.24

**Grand master (3-level system) or systems with multiple master keys:** Add to the "Stock master keyed or non stock KD, KA" price. Great grand master keyed (4-level system or higher), call factory for price.

**Add on price \$17.64**

Lock face stamping available separately  
**Add on \$9.92 price each per lock**



**WARNING:** This product can expose you to chemicals including chromium, which is known to the State of California to cause cancer and birth defects or other reproductive harm. For more information go to [www.P65Warnings.ca.gov](http://www.P65Warnings.ca.gov).

## L78 Drawer Latch Lock



L78V



L78I

**Standard function:** Spring latch. **Reversible:** Locks are field reversible into any of the 4 handings (drawer VH or IH, door LH or RH). **Handing:** See handing chart on page 5 for proper handing of locks. **Packed 10 per box.**

Item	Handing	Finish	Fits Mat.	Pinning	Pin Tumbler Keying	Weight	Price Each
L78V	VH	26D, US3	1-1/8"	5 pin	KD, KA 101, 102	8.6 lbs/box	\$100.26
L78V	VH	26D, US3	1-1/8"	6 pin	Stock master keyed or non stock KD, KA	8.6 lbs/box	\$109.22
L78V	VH	26D, US3	1-3/8"	5 pin	KD, KA 101, 102	9.0 lbs/box	\$102.27
L78V	VH	26D, US3	1-3/8"	6 pin	Stock master keyed or non stock KD, KA	9.0 lbs/box	\$111.24
L78I	IH	26D, US3	1-1/8"	5 pin	KD, KA 101, 102	8.6 lbs/box	\$100.26
L78I	IH	26D, US3	1-1/8"	6 pin	Stock master keyed or non stock KD, KA	8.6 lbs/box	\$109.22
L78I	IH	26D, US3	1-3/8"	5 pin	KD, KA 101, 102	9.0 lbs/box	\$102.27
L78I	IH	26D, US3	1-3/8"	6 pin	Stock master keyed or non stock KD, KA	9.0 lbs/box	\$111.24

**Grand master (3-level system) or systems with multiple master keys:** Add to the "Stock master keyed or non stock KD, KA" price. Great grand master keyed (4-level system or higher), call factory for price.

**Add on price \$17.64**

Lock face stamping available separately  
**Add on \$9.92 price each per lock**



**WARNING:** This product can expose you to chemicals including chromium, which is known to the State of California to cause cancer and birth defects or other reproductive harm. For more information go to [www.P65Warnings.ca.gov](http://www.P65Warnings.ca.gov).

# LC SERIES Less Cylinder for Schlage

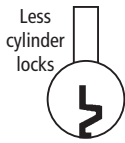

Less cylinder locks  
For SCHLAGE style original or replacement cylinders

**Schlage:** Chambers standard or Primus/ Everest Schlage key-in-knob cylinders.  
**Compatibility:** Accepts third-party Schlage-compatible key-in-knob or deadbolt cylinders including ILCO #1599, Kaba, GMS and others. Also accepts electronic cylinders such as Videx, ASSA Cliq and Medeco Logic.

**Assa:** Requires use of 1-3/8" lock. Works with Assa cylinder #65611.  
**Medeco:** Requires use of 1-3/8" lock.  
6 pin #20-009S4  
5 pin #20-008S4  
Biaxial: 6 pin #20W009S4  
5 pin #20W008S4  
Keymark: 6 pin #20K009S4  
Key retaining: #20W200S1

**Accessories:** Additional accessories are available for these products. See accessories section or consult factory.  
**Cylinders:** See page 39 for Schlage C cylinders. See page 48 for additional parts pricing.

## 700LC Door Deadbolt Lock



ANSI/BHMA A156.11  
Grade 1, E07121

Woodwork Institute (WI)  
acknowledged product

**Standard function:** Key removable in locked or unlocked position. Standard locks are non-handed. **700LCA includes:** 10-360 universal driver and 10-361 tailpiece for Schlage compatible cylinders. **700LCM includes:** 10-360 universal driver, 10-362 tailpiece for Schlage compatible cylinders, 10-363 tailpiece for Medeco cylinders and 10-364 tailpiece for Assa cylinders. **Packed 10 per box.**

Item	Finish	Fits Material	Cylinder	Description	Weight	Price Each
700LCA	26D, US3	1-1/8"	N/A	Less cylinder, door	5.6 lbs/box	\$66.06
700LCM	26D, US3	1-3/8"	N/A	Less cylinder, door	5.5 lbs/box	\$68.06
700LCA	10B	1-1/8"	N/A	Less cylinder, door	5.6 lbs/box	\$78.62
700LCM	10B	1-3/8"	N/A	Less cylinder, door	5.5 lbs/box	\$80.31

Item	Description	Packed	Price Each
78-KABA-CONV	Conversion kit for KABA cylinders	Packed Each	\$7.47



**WARNING:** This product can expose you to chemicals including chromium, which is known to the State of California to cause cancer and birth defects or other reproductive harm. For more information go to [www.P65Warnings.ca.gov](http://www.P65Warnings.ca.gov).

## 800LC Drawer Deadbolt Lock



ANSI/BHMA A156.11  
Grade 1, E07041

Woodwork Institute (WI)  
acknowledged product

**Standard function:** Key removable in locked or unlocked position. Standard locks are non-handed. **800LCA includes:** 10-360 universal driver and 10-361 tailpiece for Schlage compatible cylinders. **800LCM includes:** 10-360 universal driver, 10-362 tailpiece for Schlage compatible cylinders, 10-363 tailpiece for Medeco cylinders and 10-364 tailpiece for Assa cylinders. **Packed 10 per box.**

Item	Finish	Fits Material	Cylinder	Description	Weight	Price Each
800LCA	26D, US3	1-1/8"	N/A	Less cylinder, drawer	5.6 lbs/box	\$66.06
800LCM	26D, US3	1-3/8"	N/A	Less cylinder, drawer	5.5 lbs/box	\$68.06
800LCA	10B	1-1/8"	N/A	Less cylinder, drawer	5.6 lbs/box	\$78.62
800LCM	10B	1-3/8"	N/A	Less cylinder, drawer	5.5 lbs/box	\$80.31

Item	Description	Packed	Price Each
78-KABA-CONV	Conversion kit for KABA cylinders	Packed Each	\$7.47



**WARNING:** This product can expose you to chemicals including chromium, which is known to the State of California to cause cancer and birth defects or other reproductive harm. For more information go to [www.P65Warnings.ca.gov](http://www.P65Warnings.ca.gov).

## 820LC Cam Lock



**Includes:** 720-PL3 (anti-rotation plate), lost-motion and key retaining door/drawer cam shifters, 720-3-1 and 720-3-2 cams. Additional cams available separately. *Due to overall length of cylinder, installation may require use of trim collar. See page 42 for details.* **Note:** This lock does not accept Medeco cylinders. **Packed 10 per box.**

Item	Finish	Cyl. Length	Cylinder	Description	Weight	Price Each
820LC	26D, US3	1-23/32"	N/A	Less cylinder	4.6 lbs/box	\$67.78

Item	Description	Packed	Price Each
Additional cams	720-3-1, 720-3-2, 720-3-3, 720-3-4, 720-3-5	Packed Each	\$3.46
Trim Collars	TR201 (1/8"), TR202 (1/4"), TR203 (3/8"), TR204 (5/32"), TR200A (Pkg)	Packed Each	See page 37
SW-1	Switch accessory pack	Packed Each	\$13.33
720-PL3	Anti-rotation plate	Packed Each	\$2.77



**WARNING:** This product can expose you to chemicals including chromium, which is known to the State of California to cause cancer and birth defects or other reproductive harm. For more information go to [www.P65Warnings.ca.gov](http://www.P65Warnings.ca.gov).

# LC SERIES Less Cylinder for Schlage

## 850LC Deadlatching Drawer Lock



Standard function: Spring latch with deadlocking mechanism. Turn lock 90 degrees for door function. Includes: Matching lip strike. Packed 10 per box.

Item	Finish	Fits Material	Cylinder	Description	Weight	Price Each
850LCA	26D, US3	1-1/8"	N/A	Less cylinder, drawer	6.7 lbs/box	\$83.39
850LCM	26D, US3	1-3/8"	N/A	Less cylinder, drawer	7.0 lbs/box	\$88.97



**WARNING:** This product can expose you to chemicals including chromium, which is known to the State of California to cause cancer and birth defects or other reproductive harm. For more information go to [www.P65Warnings.ca.gov](http://www.P65Warnings.ca.gov).

## 829R-LC Showcase/Ratchet Lock



Standard function: Key removable in locked or unlocked position. Includes: 729RS-1 strap for 1/4" panel thickness. Packed 10 per box.

Item	Finish	Fits Material	Cylinder	Description	Weight	Price Each
829R-LC	26D	For 1/4" panels	N/A	Less cylinder	5.3 lbs/box	\$83.55

Item	Description	Packed	Price Each
829-MD	Optional Medeco driver pack - required if using Medeco original cylinders	Packed Each	\$12.82
729RS-2	Optional strap for 3/8" panel thickness	Packed Each	\$11.47
729RS-3	Optional strap for maximum 5/8", minimum 3/8" panel thickness	Packed Each	\$17.35



**WARNING:** This product can expose you to chemicals including chromium, which is known to the State of California to cause cancer and birth defects or other reproductive harm. For more information go to [www.P65Warnings.ca.gov](http://www.P65Warnings.ca.gov).

Complies with clause 6.3 (8.2-8.4) of ANSI/BHMA A156.11 ANSI standards

## L78-LC Door Latch Locks

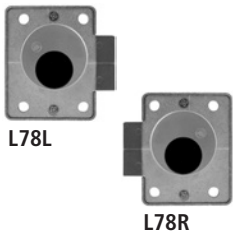

Standard function: Spring latch. Reversible: Locks are field reversible into any of the 4 handings (drawer VH or IH, door LH or RH). Handing: See the handing chart on page 5 for proper handing of locks. Packed 10 per box.

Item	Handing	Finish	Fits Mat.	Cylinder	Description	Weight	Price Each
L78L-LCA	LH	26D, US3	1-1/8"	N/A	Less cylinder, LH door	7.0 lbs/box	\$87.10
L78L-LCM	LH	26D, US3	1-3/8"	N/A	Less cylinder, LH door	7.4 lbs/box	\$89.12
L78R-LCA	RH	26D, US3	1-1/8"	N/A	Less cylinder, RH door	7.0 lbs/box	\$87.10
L78R-LCM	RH	26D, US3	1-3/8"	N/A	Less cylinder, RH door	7.4 lbs/box	\$89.12



**WARNING:** This product can expose you to chemicals including chromium, which is known to the State of California to cause cancer and birth defects or other reproductive harm. For more information go to [www.P65Warnings.ca.gov](http://www.P65Warnings.ca.gov).

## L78-LC Drawer Latch Locks

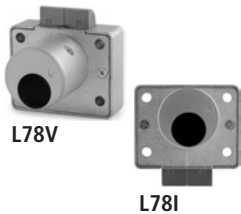

Standard function: Spring latch. Reversible: Locks are field reversible into any of the 4 handings (drawer VH or IH, door LH or RH). Handing: See the handing chart on page 5 for proper handing of locks. Packed 10 per box.

Item	Handing	Finish	Fits Mat.	Cylinder	Description	Weight	Price Each
L78V-LCA	VH	26D, US3	1-1/8"	N/A	Less cylinder, VH drawer	7.0 lbs/box	\$87.10
L78V-LCM	VH	26D, US3	1-3/8"	N/A	Less cylinder, VH drawer	7.4 lbs/box	\$89.12
L78I-LCA	IH	26D, US3	1-1/8"	N/A	Less cylinder, IH drawer	7.0 lbs/box	\$87.10
L78I-LCM	IH	26D, US3	1-3/8"	N/A	Less cylinder, IH drawer	7.4 lbs/box	\$89.12



**WARNING:** This product can expose you to chemicals including chromium, which is known to the State of California to cause cancer and birth defects or other reproductive harm. For more information go to [www.P65Warnings.ca.gov](http://www.P65Warnings.ca.gov).

## LC SERIES Less Cylinder for Schlage (works with locks on pages 25-26)

**DID YOU KNOW?** Our less cylinder for Schlage cabinet lock bodies accept ILCO #1599 replacement cylinders? Our Schlage compatible "less cylinder" cabinet locks are compatible for use with the ILCO key-in-knob #1599 replacement cylinder. The #1599 is available in 32 keyways allowing you to key your cabinets to match your facility door hardware.

### AVAILABLE KEYWAYS

Arrow 1179.....AA	Dominion 1054F.....DA	Russwin 981R.....RA	Schlage F.....SF
Corbin 59 A1-2.....CD	Ilco Composite.....NA	Russwin D1.....RB	Schlage C.....SC
Corbin 60.....CA	Kwikset 1176.....KS	Russwin 981/852 Composite.....RC	Segal 9.....FA
Corbin 67.....CB	Lockwood 1004.....LA	Sargent LA.....GA	Weiser/Falcon E.....WA
Corbin 77.....CC	Lori 80.....UE	Sargent LA-LC.....GB	Weiser 1555.....WE
Corbin/Russwin L4.....CE	Lori Centric 90.....UD	Sargent RA-RC.....GC	ILCO X1054K.....UA
Dexter 67.....XE	Lori Composite.....NB	Schlage C-L.....SX	Yale 8 (5 pin only).....YA
D05-D06.....DB	Lori L100.....UB	Schlage E.....SE	Yale GA (5 pin only).....YG

# LC SERIES Less Cylinder for Sargent

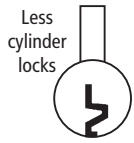

For SARGENT original deadbolt-style cylinders

**Compatibility:** Accepts Sargent C480-2 (13-3457) deadbolt cylinder.  
**Accessories:** Additional accessories are available for these products. See accessories section or consult factory.

**Cylinders:** Not included.

## 754LC Door Deadbolt Lock



### ACCEPTS SARGENT C480-2 (13-3457) DEADBOLT CYLINDER

**Standard function:** Key removable in locked or unlocked position. Standard locks are non-handed. **Packed 10 per box.**

Item	Finish	Fits Material	Cylinder	Description	Weight	Price Each
754LC	26D, US3	1-3/8"	N/A	Less cylinder, door	5.7 lbs/box	\$68.72



**WARNING:** This product can expose you to chemicals including chromium, which is known to the State of California to cause cancer and birth defects or other reproductive harm. For more information go to [www.P65Warnings.ca.gov](http://www.P65Warnings.ca.gov).

## 854LC Drawer Deadbolt Lock



### ACCEPTS SARGENT C480-2 (13-3457) DEADBOLT CYLINDER

**Standard function:** Key removable in locked or unlocked position. Standard locks are non-handed. **Packed 10 per box.**

Item	Finish	Fits Material	Cylinder	Description	Weight	Price Each
854LC	26D, US3	1-3/8"	N/A	Less cylinder, drawer	5.7 lbs/box	\$68.72



**WARNING:** This product can expose you to chemicals including chromium, which is known to the State of California to cause cancer and birth defects or other reproductive harm. For more information go to [www.P65Warnings.ca.gov](http://www.P65Warnings.ca.gov).

# SLT SERIES Rim Cylinder Conversion Kit

**Conversion Kit:** allows you to convert a SALTO US rim cylinder into a latch or deadbolt cabinet lock. Also compatible with most major US rim cylinders.

**Standard Function:** will work for cabinet doors or drawers.

**Accepts:** SALTO G9B1 GEO US rim cylinder and other third party US rim cylinders.

**Rim Cylinder:** not included

**STL-01 Includes:** 10-350 plastic spacer, L78ST-1-SS stainless steel lip strike, SLT-TR 21/64" trim bezel  
**STL-02 Includes:** 10-350 plastic spacer, 10-054 1/4" plastic bar strike, SLT-TR 21/64" trim bezel

## SLT Rim Cylinder Conversion Kit

Cabinet Lock Conversion Kit for SALTO Electronic Rim Cylinder. Also compatible with other third party US rim cylinders. Cylinders not included.

**Standard function:** Non-handed. Can be used for doors or drawers. **Packed 10 per box.**



SLT-01



SLT-02

Item	Function	Finish	Cyl. Length	Barrel Diameter	Weight	Price Each
SLT-01	Latch Bolt	26D	Adjustable: determined by provided rim cylinder screws and tailpiece	1-9/64"	4.87 lbs/box	\$104.29
SLT-02	Dead Bolt					



**WARNING:** This product can expose you to chemicals including chromium, which is known to the State of California to cause cancer and birth defects or other reproductive harm. For more information go to [www.P65Warnings.ca.gov](http://www.P65Warnings.ca.gov).



# IC CORE Corbin/Russwin

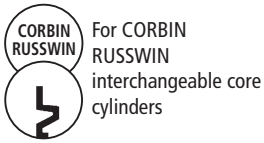

For CORBIN  
RUSSWIN  
interchangeable core  
cylinders

**Compatibility:** Accepts Corbin/Russwin 6 or 7 pin IC cores.

**Cylinders:** Not included.

**Cores:** Corbin/Russwin cores not included.

**Accessories:** Additional accessories are available for these products. See accessories section or consult factory.

## CR1125RD Rim (Surface) Mount Deadbolt Locks



**CR1125RDVH**  
Woodwork Institute (WI)  
acknowledged product

**Standard function:** Key removable in locked or unlocked position. **Includes:** 1125-1 spacer for 6-pin cores and solid rectangular strike.  
**Handing:** See the handing chart on page 5 for proper handing of locks. **Packed 10 per box.**

Item	Handing	Finish	Fits Mat.	Description	Weight	Price Each
CR1125RD	RH	26D	1-1/8"	Rim <b>deadbolt</b> , right-hand door lock body	5.0 lbs/box	\$75.81
CR1125RD	LH	26D	1-1/8"	Rim <b>deadbolt</b> , left-hand door lock body	5.0 lbs/box	\$75.81
CR1125RD	VH	26D	1-1/8"	Rim <b>deadbolt</b> , vertical drawer lock body	5.0 lbs/box	\$75.81



**WARNING:** This product can expose you to chemicals including chromium, which is known to the State of California to cause cancer and birth defects or other reproductive harm. For more information go to [www.P65Warnings.ca.gov](http://www.P65Warnings.ca.gov).

## CR1125RL Rim (Surface) Mount Latch Locks



**CR1125RLVH**  
Woodwork Institute (WI)  
acknowledged product

**Standard function:** Spring latch. For cabinet doors, place lock on side. **Includes:** 1125-1 spacer for 6-pin cores and lip strike.  
**Packed 10 per box.**

Item	Handing	Finish	Fits Mat.	Description	Weight	Price Each
CR1125RL	VH	26D	1-1/8"	Rim <b>latch</b> , vertical drawer lock body	5.0 lbs/box	\$75.81



**WARNING:** This product can expose you to chemicals including chromium, which is known to the State of California to cause cancer and birth defects or other reproductive harm. For more information go to [www.P65Warnings.ca.gov](http://www.P65Warnings.ca.gov).

## CR25 Cam Lock



**Includes:** 720-PL3 (anti-rotation plate), lost-motion and key retaining door/drawer cam shifters, 720-3-1 and 720-3-2 cams and 1125-1 spacer for 6-pin cores. Additional cams available separately. **Packed 10 per box.**

Item	Finish	Cyl. Length	Description	Weight	Price Each
CR25LM/DM	26D	1-7/16"	IC cam lock body	4.9 lbs/box	\$67.91

  

Item	Description	Packed	Price Each
Additional cams	720-3-1, 720-3-2, 720-3-3, 720-3-4, 720-3-5	Packed Each	\$3.46
Trim Collars	TR201 (1/8"), TR202 (1/4"), TR203 (3/8"), TR204 (5/32"), TR200A (Pkg)	Packed Each	See page 37
SW-1	Switch accessory pack	Packed Each	\$13.33
720-PL3	Anti-rotation plate	Packed Each	\$2.77



**WARNING:** This product can expose you to chemicals including chromium, which is known to the State of California to cause cancer and birth defects or other reproductive harm. For more information go to [www.P65Warnings.ca.gov](http://www.P65Warnings.ca.gov).

# IC CORE Medeco / Assa / Yale

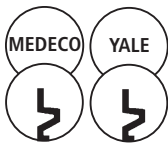

For MEDECO/YALE style large format interchangeable core cylinders

**IMPORTANT:** Keymark cores require SFIC cabinet lock bodies.

**Medeco Core:** Accepts Medeco (6-pin) IC core cylinder #32-0201. Medeco core requires use of Medeco #94-0009 or Olympus 931-1M spacer. The 931DR/DW ships standard with Olympus 931-1M spacer.

**Yale Core:** Accepts Yale 1210 Series (6-pin) IC core cylinder or Medeco's #31-0100 Yale compatible cylinder.

**Assa Core:** Accepts Assa's Yale 6 pin compatible large format IC core.

**Accessories:** Additional accessories are available for these products. See the accessories section or consult factory.

**Cylinders:** Not included.

## 931DR Door Deadbolt Lock



Woodwork Institute (WI) acknowledged product

**Standard function:** Key removable in locked or unlocked position. Standard locks are non-handed. **Key-retaining:** For key removable in locked position only, specify the key-retaining part-numbers below. **Handing:** See handing chart on page 5 for proper handing of locks (left or right). **Includes:** 931-1M spacer or Medeco 6-pin IC core cylinders. **Packed 10 per box.**

Item	Finish	Fits Material	Cylinder	Description	Weight	Price Each
931DR	26D, US3	1-3/8"	N/A	IC door lock body	6.5 lbs/box	\$85.10
931DR-KR	26D, US3	1-3/8"	N/A	IC door lock body (key retaining)	6.5 lbs/box	\$92.86

**Key-retaining:** Cycle to "locked" position before inserting core.

**\*\*IMPORTANT NOTE:** Medeco Keymark cylinders require SFIC lock bodies (see 721DR).



**WARNING:** This product can expose you to chemicals including chromium, which is known to the State of California to cause cancer and birth defects or other reproductive harm. For more information go to [www.P65Warnings.ca.gov](http://www.P65Warnings.ca.gov).

## 931DW Drawer Deadbolt Lock



Woodwork Institute (WI) acknowledged product

**Standard function:** Key removable in locked or unlocked position. Standard locks are non-handed. **Key-retaining:** For key removable in locked position only, specify the key-retaining part-numbers above. **Handing:** See handing chart on page 5 for proper handing of locks (vertical or inverted). **Includes:** 931-1M spacer or Medeco 6-pin IC core cylinders. **Packed 10 per box.**

Item	Finish	Fits Material	Cylinder	Description	Weight	Price Each
931DW	26D, US3	1-3/8"	N/A	IC drawer lock body	6.5 lbs/box	\$85.10
931DW-KR	26D, US3	1-3/8"	N/A	IC drawer lock body (key retaining)	6.5 lbs/box	\$92.86

**Key-retaining:** Cycle to "locked" position before inserting core.

**\*\*IMPORTANT NOTE:** Medeco Keymark cylinders require SFIC lock bodies (see 721DW).



**WARNING:** This product can expose you to chemicals including chromium, which is known to the State of California to cause cancer and birth defects or other reproductive harm. For more information go to [www.P65Warnings.ca.gov](http://www.P65Warnings.ca.gov).

# IC CORE Medeco



For MEDECO style large format interchangeable core cylinders

**IMPORTANT:** Keymark cores require SFIC cabinet lock bodies.

**Medeco Core:** Accepts Medeco (6-pin) IC core cylinder #32-0201.

**Accessories:** Additional accessories are available for these products. See the accessories section or consult factory.

**Cylinders:** Not included.

## ME93 Cam Lock



For Medeco IC\*\*

**Includes:** 720-PL3 (anti-rotation plate), lost-motion and key retaining door/drawer cam shifters, 720-3-1 and 720-3-2 cams. Additional cams available separately. **Packed 10 per box.**

Item	Finish	Cyl. Length	Description	Weight	Price Each
ME93LM/DM	26D	1-7/16"	IC cam lock body for Medeco IC	3.6 lbs/box	\$67.91

Item	Description	Packed	Price Each
Additional cams	720-3-1, 720-3-2, 720-3-3, 720-3-4, 720-3-5	Packed Each	\$3.46
Trim Collars	TR201 (1/8"), TR202 (1/4"), TR203 (3/8"), TR204 (5/32"), TR200A (Pkg)	Packed Each	See page 37
SW-1	Switch accessory pack	Packed Each	\$13.33
720-PL3	Anti-rotation plate	Packed Each	\$2.77

**\*\*IMPORTANT NOTE:** Medeco Keymark cylinders require SFIC lock bodies (see 720 Series locks).



**WARNING:** This product can expose you to chemicals including chromium, which is known to the State of California to cause cancer and birth defects or other reproductive harm. For more information go to [www.P65Warnings.ca.gov](http://www.P65Warnings.ca.gov).

## IC CORE Yale



For YALE style large format interchangeable core cylinders

**Yale Core:** Accepts Yale 1210 Series (6-pin) IC core cylinder.  
**Assa Core:** Accepts Assa's Yale 6-pin compatible large format IC core.  
**Cylinders:** Not included.

**Accessories:** Additional accessories are available for these products. See the accessories section or consult factory.

## YA93 Cam Lock



For Yale IC

**Includes:** 720-PL3 (anti-rotation plate), lost-motion and key retaining door/drawer cam shifters, 720-3-1 and 720-3-2 cams, and separate internal drivers for use with Yale and/or Assa's Yale cylinder or Medeco's Yale cylinder. Additional cams available separately.  
**Packed 10 per box.**

Item	Finish	Cyl. Length	Description	Weight	Price Each
YA93LM/DM	26D	1-7/16"	IC cam lock body for Yale/Assa IC	3.7 lbs/box	\$67.91
Item	Description			Packed	Price Each
Additional cams	720-3-1, 720-3-2, 720-3-3, 720-3-4, 720-3-5			Packed Each	\$3.46
Trim Collars	TR201 (1/8"), TR202 (1/4"), TR203 (3/8"), TR204 (5/32"), TR200A (Pkg)			Packed Each	See page 37
SW-1	Switch accessory pack			Packed Each	\$13.33
720-PL3	Anti-rotation plate			Packed Each	\$2.77



**WARNING:** This product can expose you to chemicals including chromium, which is known to the State of California to cause cancer and birth defects or other reproductive harm. For more information go to [www.P65Warnings.ca.gov](http://www.P65Warnings.ca.gov).

## IC CORE Sargent



For SARGENT interchangeable core cylinders

**Compatibility:** Accepts Sargent 6300 series and Sargent "Degree" interchangeable cores.  
**Cylinders:** Not included.

**Accessories:** Additional accessories are available for these products. See accessories section or consult factory.

## SA54 Cam Lock



For Sargent IC

**Includes:** 720-PL3 (anti-rotation plate), lost-motion and key retaining door/drawer cam shifters, 720-3-1 and 720-3-2 cams.  
**Packed 10 per box.**

Item	Finish	Cyl. Length	Description	Weight	Price Each
SA54LM/DM	26D	1-7/16"	IC cam lock body for Sargent IC	3.9 lbs/box	\$67.91
Item	Description			Packed	Price Each
Additional cams	720-3-1, 720-3-2, 720-3-3, 720-3-4, 720-3-5			Packed Each	\$3.46
Trim Collars	TR201 (1/8"), TR202 (1/4"), TR203 (3/8"), TR204 (5/32"), TR200A (Pkg)			Packed Each	See page 37
SW-1	Switch accessory pack			Packed Each	\$13.33
720-PL3	Anti-rotation plate			Packed Each	\$2.77



**WARNING:** This product can expose you to chemicals including chromium, which is known to the State of California to cause cancer and birth defects or other reproductive harm. For more information go to [www.P65Warnings.ca.gov](http://www.P65Warnings.ca.gov).

# IC CORE Schlage Full Size



For SCHLAGE full-size interchangeable core cylinders

**Compatibility:** Accepts Schlage-style full-size / large format IC cores  
**Schlage:** Chambers both standard or Primus/Everest Schlage full-size interchangeable cores.

**Mul-T-Lock:** Chambers Mul-T-Lock large format IC cores.  
**Cylinders:** Schlage full-size IC cores not included.

**Accessories:** Additional accessories are available for these products. See accessories section or consult factory.

## 777 Door Deadbolt Lock



ANSI/BHMA A156.11  
Grade 1, E07121

Woodwork Institute (WI)  
acknowledged product

**Standard:** Key removable in locked or unlocked position. Standard locks are non-handed. **Key-retaining:** For key removable in locked position only, specify the key-retaining part-numbers. **Handing:** See chart on page 5 for proper handing of locks (left-hand or right-hand).  
**Packed 10 per box.**

Item	Handing	Finish	Fits Material	Description	Weight	Price Each
777ICP	N/A	26D, US3	1-7/16"	Schlage IC door lock body	7.3 lbs/box	\$100.56
777ICP	N/A	10B	1-7/16"	Schlage IC door lock body	7.3 lbs/box	\$107.63

### KEY-RETAINING FUNCTION (KEY REMOVABLE IN LOCKED POSITION ONLY)

Item	Handing	Finish	Fits Material	Description	Weight	Price Each
777IC-DRK	RH or LH	26D, US3	1-7/16"	Key-retaining, <b>Classic Cores</b>	7.3 lbs/box	\$108.33
777P-DRK	RH or LH	26D, US3	1-7/16"	Key-retaining, <b>Primus/Everest Cores</b>	7.3 lbs/box	\$108.33
777IC-DRK	RH or LH	10B	1-7/16"	Key-retaining, <b>Classic Cores</b>	7.3 lbs/box	\$115.38
777P-DRK	RH or LH	10B	1-7/16"	Key-retaining, <b>Primus/Everest Cores</b>	7.3 lbs/box	\$115.38

**Key-retaining:** Cycle to "locked" position before inserting core.



**WARNING:** This product can expose you to chemicals including chromium, which is known to the State of California to cause cancer and birth defects or other reproductive harm. For more information go to [www.P65Warnings.ca.gov](http://www.P65Warnings.ca.gov).

## 888 Drawer Deadbolt Lock



ANSI/BHMA A156.11  
Grade 1, E07041

Woodwork Institute (WI)  
acknowledged product

**Standard:** Key removable in locked or unlocked position. Standard locks are non-handed. **Key-retaining:** For key removable in locked position only, specify the key-retaining part-numbers below. **Handing:** See chart on page 5 for proper handing of locks (vertical or inverted).  
**Packed 10 per box.**

Item	Handing	Finish	Fits Material	Description	Weight	Price Each
888ICP	N/A	26D, US3	1-7/16"	Schlage IC drawer lock body	7.3 lbs/box	\$100.56
888ICP	N/A	10B	1-7/16"	Schlage IC drawer lock body	7.3 lbs/box	\$107.63

### KEY-RETAINING FUNCTION (KEY REMOVABLE IN LOCKED POSITION ONLY)

Item	Handing	Finish	Fits Material	Description	Weight	Price Each
888IC-DWK	IH or VH	26D, US3	1-7/16"	Key-retaining, <b>Classic Cores</b>	7.3 lbs/box	\$108.33
888P-DWK	IH or VH	26D, US3	1-7/16"	Key-retaining, <b>Primus/Everest Cores</b>	7.3 lbs/box	\$108.33
888IC-DWK	IH or VH	10B	1-7/16"	Key-retaining, <b>Classic Cores</b>	7.3 lbs/box	\$115.38
888P-DWK	IH or VH	10B	1-7/16"	Key-retaining, <b>Primus/Everest Cores</b>	7.3 lbs/box	\$115.38

**Key-retaining:** Cycle to "locked" position before inserting core.



**WARNING:** This product can expose you to chemicals including chromium, which is known to the State of California to cause cancer and birth defects or other reproductive harm. For more information go to [www.P65Warnings.ca.gov](http://www.P65Warnings.ca.gov).

## 920 Cam Lock



ANSI/BHMA A156.11  
Grade 1  
E07261/E07271

Woodwork Institute (WI)  
acknowledged product

**Includes:** 720-PL3 (anti-rotation plate), lost-motion and key retaining door/drawer cam shifters, 720-3-1 and 720-3-2 cams. Additional cams available separately. **Packed 10 per box.**

Item	Finish	Cyl. Length	Description	Weight	Price Each
920LM/DM	26D, US3	1-7/16"	Schlage IC cam lock body	4.1 lbs/box	\$67.91

Item	Description	Packed	Price Each
Additional cams	720-3-1, 720-3-2, 720-3-3, 720-3-4, 720-3-5	Packed Each	\$3.46
Trim Collars	TR201 (1/8"), TR202 (1/4"), TR203 (3/8"), TR204 (5/32"), TR200A (Pkg)	Packed Each	See page 37
SW-1	Switch accessory pack	Packed Each	\$13.33
720-PL3	Anti-rotation plate	Packed Each	\$2.77



**WARNING:** This product can expose you to chemicals including chromium, which is known to the State of California to cause cancer and birth defects or other reproductive harm. For more information go to [www.P65Warnings.ca.gov](http://www.P65Warnings.ca.gov).

# IC CORE Schlage Full Size | ENCLOSURE LOCKS

## L92V Drawer Latch Lock



Standard function: Spring latch. For cabinet doors, place lock on side. Packed 10 per box.

Item	Finish	Cyl. Length	Description	Weight	Price Each
L92V	26D, US3	1-7/16"	Schlage IC drawer latch lock body	6.8 lbs/box	\$94.86



**WARNING:** This product can expose you to chemicals including chromium, which is known to the State of California to cause cancer and birth defects or other reproductive harm. For more information go to [www.P65Warnings.ca.gov](http://www.P65Warnings.ca.gov).

## 929R Showcase/Ratchet Lock



Standard: Key removable in locked or unlocked position. Includes: 729RS-1 strap for 1/4" panel thickness. Packed 10 per box.

Item	Finish	Size	Description	Weight	Price Each
929R	26D	For 1/4" panels	Schlage IC ratchet lock body for sliding doors	5.1 lbs/box	\$81.98

Item	Description	Packed	Price Each
729RS-2	Optional strap for 3/8" panel thickness	Packed Each	\$11.47
729RS-3	Optional strap for maximum 5/8", minimum 3/8" panel thickness	Packed Each	\$17.35



**WARNING:** This product can expose you to chemicals including chromium, which is known to the State of California to cause cancer and birth defects or other reproductive harm. For more information go to [www.P65Warnings.ca.gov](http://www.P65Warnings.ca.gov).

Complies with clause 6.3 (8.2~8.4) of ANSI/BHMA A156.11 ANSI standards

Woodwork Institute (WC) acknowledged product

# ENCLOSURE LOCKS

## 725RSL [SFIC] Enclosure Locks for NEMA Traffic Control Boxes

Shown as  
VH DRAWER



725RSL-VH

**IMPORTANT:** For standard latch bolt, see 725RL or 725ML. **Retrofits:** Best 5L7RL (with option code -SL). **Function:** "square latching bolt." 725RSL is a specialized function for use in metal electrical/traffic enclosure boxes. **Includes:** Solid brass cylinder housing (US26D or US4 finish only). **Handing:** See chart on page 5. **Packed 10 per box.**

Item	Handing	Finish	Description	Weight	Price Each
725RSL-RH	Right-Hand	26D, US4	RH Door - Square Latch/Spring Deadbolt	6.0 lbs/box	\$69.63
725RSL-LH	Left-Hand	26D, US4	LH Door - Square Latch/Spring Deadbolt	6.0 lbs/box	\$69.63
725RSL-VH	Vertical-Hand	26D, US4	VH Drawer - Square Latch/Spring Deadbolt	6.0 lbs/box	\$69.63



**WARNING:** This product can expose you to chemicals including chromium, which is known to the State of California to cause cancer and birth defects or other reproductive harm. For more information go to [www.P65Warnings.ca.gov](http://www.P65Warnings.ca.gov).

## E5 [CCL CR] Enclosure Locks for NEMA Traffic Control Boxes

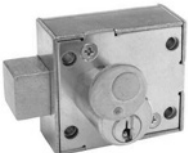

E5D-RH / B-E5D-RH  
Spring Deadbolt  
[Right-Hand]



E5L-RH  
Spring Latchbolt  
[Right-Hand]

**Function:** Spring deadbolt or spring latchbolt for use in metal electrical/traffic enclosure boxes. **Includes:** Solid brass cylinder in CCL CR keyway with zinc die cast housing, lock body and bolt. **Retrofits:** CCL 55481, A55481. **Handing:** See chart on page 5. **Packed 10 per box.**

Item	Keyway	Handing	Finish	Description	Keying	Weight	Price Each
E5D-RH	CR	RH	US3	RH Door - Square Latch/Spring Deadbolt	Stock KA #2 Master keyed or non-stock KD/KA	7.0 lbs/box	\$46.88 \$56.66
B-E5D-RH	CR	RH	Solid Brass (US4)	RH Door - Square Latch/Spring Deadbolt	Stock KA #2 Master keyed or non-stock KD/KA	8.0 lbs/box	\$51.57 \$62.33
E5L-RH	CR	RH	US3	RH Door - Spring Latch	Stock KA #2 Master keyed or non-stock KD/KA	7.0 lbs/box	\$46.88 \$56.66
E5DG-RH	GR	RH	US3	RH Door - Square Latch/Spring Deadbolt	Master keyed or non-stock KD/KA	7.0 lbs/box	\$56.66
B-E5DG-RH	GR	RH	Solid Brass (US4)	RH Door - Square Latch/Spring Deadbolt	Master keyed or non-stock KD/KA	8.0 lbs/box	\$62.33
E5LG-RH	GR	RH	US3	RH Door - Spring Latch	Master keyed or non-stock KD/KA	7.0 lbs/box	\$56.66

### Keyblanks & Cut Keys

KBCR-5-NP KBCR-KA2-NP KBCR-5-CUST	CR keyway	Keyblank Cut key to KA #2 Custom cut key	\$3.53 \$5.24 \$5.24
KBGR-5-NP KBGR-5-CUST	GR keyway	Keyblank Custom cut key	\$3.53 \$5.24



**WARNING:** This product can expose you to chemicals including chromium, which is known to the State of California to cause cancer and birth defects or other reproductive harm. For more information go to [www.P65Warnings.ca.gov](http://www.P65Warnings.ca.gov).

# ENCLOSURE LOCKS

## P3L Police Call Box, Fire Alarm Lock / Warded Keyway



**Retrofits:** CCL R557SGS. **Function:** Spring loaded latch, right-hand, warded keyway for use in police call boxes or fire alarm boxes. **Includes:** One standard length key per lock. **Handing:** Right-hand standard. **Packed 10 per box.**

Item	Finish	Keying	Weight	Price Each
P3L-RH-US3-SK	US3	Stock KA, warded key	4.2 lbs/box	\$29.76
<b>Keys</b>				
KB-P3L-SK	Standard key. Ships with lock. Also available separately.			\$6.06
KB-P3L-LK	Long key. Available separately.			\$7.72

## BEST KEYWAY Utility Cam Lock



BEST Keyway  
(non-SFIC)

**Compatibility:** Retrofits Best 5E style 3/4" diameter cam lock.

**Keyways:** Available in A, B, E, F, G, J, K, L, R keyways.

**Keys:** Use KB-400 series (See pages 39 and 40).

**Custom stamping:** See page 40.

**Keying information:** See page 6.

## B7 Best Keyway Cam Lock



Woodwork Institute (WI)  
acknowledged product

**Standard function:** Key removable in locked or unlocked position. Ships with DCNP-500-ARP (anti-rotation plate), DCNP-100-SC (straight cam) and DCNP-100-BC (reversible offset cam). **Key-retaining:** For key removable in locked position only (key-retaining), purchase optional cam shifters DCNP-200-KR (for drawers) or DCNP-200-KDR (for doors). **Optional cams and accessories:** See chart below. **Packed 10 per box.**

Item	Keyway	Finish	Cyl. Length	Pin Tumbler Keying	Weight	Price Each
B7	See below	26D	1-3/16"	O-Bit	3.1 lbs/box	\$46.20
B7	See below	26D	1-3/16"	Stock master keyed or non stock KD, KA	3.1 lbs/box	\$54.14
<b>Grand master (3-level system) or systems with multiple master keys:</b> Add to the "Stock master keyed or non stock KD, KA" price. Great grand master keyed (4-level system or higher), call factory for price.					<b>Add on price</b>	<b>\$17.64</b>

Available keyways: A, B, E, F, G, J, K, L, R (Specify keyway when ordering)

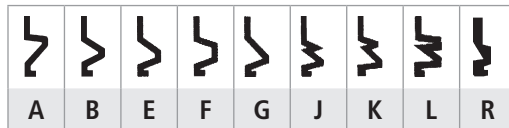

**WARNING:** This product can expose you to chemicals including chromium, which is known to the State of California to cause cancer and birth defects or other reproductive harm. For more information go to [www.P65Warnings.ca.gov](http://www.P65Warnings.ca.gov).

For keyblanks and cut keys:  
Use KB-400 series (See pages 39 and 40).

### OPTIONAL PARTS

Item	Description / Packed Each	Price Each
DCNP-500-ARP	Anti-rotation plate	\$1.17
DCNP-300-FP	Finger pull	\$2.95
DCNP-200-KR	Key-retaining shifter (Drawer)	\$2.25
DCNP-200-KDR	Key-retaining shifter (Door)	\$2.25
T37DC-NP	Number plate ring	\$0.88
DCNP-GW*	Glass washer	\$1.41
DCNP-SPW	Pronged wood washer	\$1.06
P95-SPW	Eyelet spur washer (NEW)	\$1.07
TRB7-18-26D	1/8" spacer collar, 26D	\$4.14
TRB7-14-26D	1/4" spacer collar, 26D	\$5.13
TRB7-12-26D	1/2" spacer collar, 26D	\$5.96

\*DCNP-GW is a plastic washer with a peel-and-stick adhesive back used for mounting DCN on glass.

### OPTIONAL CAMS

**Note:** Offset cams are reversible and can be used in either the inbent or outbent position.

Item	Description / Packed Each	Price Each
DCNP-HD-875	7/8" long straight cam	\$2.39
DCNP-HD-1	1" long straight cam	\$2.39
DCNP-100-SC	1-1/4" long straight cam	\$2.39
DCNP-100-SC2	1-3/4" long straight cam	\$2.39
DCNP-100-SC3	1-1/2" long straight cam	\$2.39
DCNP-100-LC	3" long straight cam	\$2.39
DCNP-100-BC	1-1/4" long cam, 5/16" offset	\$2.39
DCNP-100-BC5	1-1/4" long cam, 1/2" offset	\$2.39
DCNP-100-HC1	1-1/2" long hook cam, 5/16" offset	\$2.39
DCNP-100-HD	1-7/16" long cam, 1/2" offset	\$2.39
DCNP-100-HD2	1-3/4" long cam, 5/16" offset	\$2.39
DCNP-100-HD3	1-1/8" long cam, 5/16" offset	\$2.39
DCNP-100-LBC	1-1/2" long cam, 5/16" offset	\$2.39
DCNP-100-B1	Straight cam with oval cutout	\$2.39
DCNP-100-B2	U-shaped cam	\$2.39
DCNP-100-B3	Straight hook cam	\$2.39
DCNP-100-WB	Short cam / 90° offset arm	\$2.39

The following warning is applicable to all parts listed on this page:



**WARNING:** This product can expose you to chemicals including chromium, which is known to the State of California to cause cancer and birth defects or other reproductive harm. For more information go to [www.P65Warnings.ca.gov](http://www.P65Warnings.ca.gov).

# IC CORE "Best" Small Format



**Compatibility:** Accepts Best, Arrow, Falcon or compatible 6 or 7 pin small format interchangeable core cylinders.  
**Medeco Keymark:** Accepts Medeco Keymark cylinders.  
**Accessories:** Additional accessories are available for these products. See accessories section or consult factory.

**Cylinders:** Not included with locks. Best compatible SFIC cylinders can be purchased separately. (See cylinders on page 39)

## 720 Cam Lock



ANSI/BHMA A156.11  
Grade 1  
E07261/E07271

Woodwork Institute (WI)  
acknowledged product

**Retrofits:** Best 1E7E4. **Includes:** 720-PL3 (anti-rotation plate), lost-motion and key retaining door/drawer cam shifters, 720-3-1 and 720-3-2 cams. Additional cams available separately. **Packed 10 per box.**

Item	Finish	Cyl. Length	Description	Weight	Price Each
720LM/DM	26D, US26, US3, US4	1-7/16"	IC Cam Lock (zinc die cast body)	4.0 lbs/box	\$58.58
Item	Description			Packed	Price Each
Additional cams	720-3-1, 720-3-2, 720-3-3, 720-3-4, 720-3-5			Packed Each	\$3.46
Trim Collars	TR201 (1/8"), TR202 (1/4"), TR203 (3/8"), TR204 (5/32"), TR200A (Pkg)			Packed Each	See page 42
SW-1	Switch accessory pack			Packed Each	\$13.33
720-PL3	Anti-rotation plate			Packed Each	\$2.77



**WARNING:** This product can expose you to chemicals including chromium, which is known to the State of California to cause cancer and birth defects or other reproductive harm. For more information go to [www.P65Warnings.ca.gov](http://www.P65Warnings.ca.gov).

## 720B-DM Medical Cart/Direct Drive Cam Lock



**Retrofits:** Best 1E7D4. **Includes:** TR201 and TR202 (trim collars) and 720-3-D1 short cam. Works with BEST original direct drive cams. **Packed 10 per box.**

Item	Finish	Cyl. Length	Description	Weight	Price Each
720B-DM	26D	1-7/16"	IC Cam Lock (solid brass body)	3.9 lbs/box	\$72.09
Item	Description			Packed	Price Each
Additional cams	720-3-SC1 (switch cam)			Packed Each	\$4.59
Trim Collars	TR201 (1/8"), TR202 (1/4"), TR203 (3/8"), TR204 (5/32"), TR200A (Pkg)			Packed Each	See page 42
720-PL3	Anti-rotation plate			Packed Each	\$2.77



**WARNING:** This product can expose you to chemicals including chromium, which is known to the State of California to cause cancer and birth defects or other reproductive harm. For more information go to [www.P65Warnings.ca.gov](http://www.P65Warnings.ca.gov).

## 722S Sliding Door Push Lock



**Retrofits:** Best 2S and 2S-TBM. **Standard function:** Key removable in locked or unlocked position. **Key-retaining (KR):** Key removable in locked position only. **Material:** Solid brass body construction. **Packed 10 per box.**

Item	Finish	Fits Material	Description	Key Function	Weight	Price Each
722S	26D	3/4" - 1-1/2"	IC push lock body	Standard	5.4 lbs/box	\$84.23
722S-KR	26D	3/4" - 1-1/2"	IC Push lock body	Key-retaining	5.4 lbs/box	\$88.44
722S-TBM	26D	3/4" - 1-1/2"	IC push lock, through-bolt mount	Standard	5.8 lbs/box	\$91.25
722S-TBM-KR	26D	3/4" - 1-1/2"	IC push lock, through-bolt mount	Key-retaining	5.8 lbs/box	\$95.46
722TBM-PK	26D	TBM parts pack to convert standard to TBM (through-bolt mount)			Packed Each	\$12.48



**WARNING:** This product can expose you to chemicals including chromium, which is known to the State of California to cause cancer and birth defects or other reproductive harm. For more information go to [www.P65Warnings.ca.gov](http://www.P65Warnings.ca.gov).

## 723S Sliding Door Cylinder Housing



**Retrofits:** Best 4S. **Includes:** 3 sizes of screws (7/16", 3/4" and 1"). **Cylinders:** Requires special 207S SFIC cylinders (See cylinders on page 39). Also works with Best original #6C or #6CP cylinders. **Packed 10 per box.**

Item	Finish	Fits Material	Description	Weight	Price Each
723S	26D, US26	Adjustable	Sliding door cylinder housing	1.6 lbs/box	\$49.13



**WARNING:** This product can expose you to chemicals including chromium, which is known to the State of California to cause cancer and birth defects or other reproductive harm. For more information go to [www.P65Warnings.ca.gov](http://www.P65Warnings.ca.gov).

## 721DR Door Deadbolt Lock



ANSI/BHMA A156.11  
Grade 1, E07121

Woodwork Institute (WI)  
acknowledged product

**Retrofits:** Best 3L. **Standard function:** Key removable in locked or unlocked position. Standard locks are non-handed. **Includes:** All parts to convert between door/drawer function and to convert to key-retaining function. **Key-retaining:** Key removable in locked position only. For factory configured key-retaining locks, specify the key-retaining part-numbers below. **Handing:** See chart on page 5 for proper handing of locks (left or right). **SP1 option:** Includes prong driver with short pins for use with Sargent XC and Marks high security cylinders. **Packed 10 per box.**

Item	Finish	Fits Mat.	Description	Weight	Price Each	
721DR	26D, US26, US3	1-1/4"	IC door lock body	6.1 lbs/box	\$67.60	
721DR-SP1	26D, US26, US3	1-1/4"	IC door lock body (with short prongs)	6.1 lbs/box	\$77.34	
721DR-138	26D	1-3/8"	IC door lock body	5.8 lbs/box	\$69.56	
721DR	10B, US19	1-1/4"	IC door lock body	6.1 lbs/box	\$81.62	
721DR-SP1	10B, US19	1-1/4"	IC door lock body (with short prongs)	6.1 lbs/box	\$100.44	
<b>Door long bolt:</b> For long bolt #721-1-LB factory installed in lock (specify -LB option). Bolts available separately for \$13.05 list price each. Extends bolt projection to 1-1/2".					<b>Add on price</b>	<b>\$20.06</b>

### KEY-RETAINING FUNCTION (KEY REMOVABLE IN LOCKED POSITION ONLY)

Item	Finish	Fits Mat.	Description	Weight	Price Each	
721DR-KR	26D, US26, US3	1-1/4"	IC door lock body (key retaining)	6.1 lbs/box	\$75.36	
721DR-KRSP1	26D, US26, US3	1-1/4"	IC door lock body (key retain, short prongs)	6.1 lbs/box	\$85.10	
721DR-KR138	26D	1-3/8"	IC door lock body (key retaining)	5.8 lbs/box	\$77.32	
721DR-KR	10B, US19	1-1/4"	IC door lock body (key retaining)	6.1 lbs/box	\$89.38	
721DR-KRSP1	10B, US19	1-1/4"	IC door lock body (key retain, short prongs)	6.1 lbs/box	\$108.20	
<b>Door long bolt:</b> For long bolt #721-1-LB factory installed in lock (specify -LB option). Bolts available separately for \$13.05 list price each. Extends bolt projection to 1-1/2".					<b>Add on price</b>	<b>\$20.06</b>

**Key-retaining:** Cycle to "locked" position before inserting core.



**WARNING:** This product can expose you to chemicals including chromium, which is known to the State of California to cause cancer and birth defects or other reproductive harm. For more information go to [www.P65Warnings.ca.gov](http://www.P65Warnings.ca.gov).

## 721DW Drawer Deadbolt Lock



ANSI/BHMA A156.11  
Grade 1, E07041

Woodwork Institute (WI)  
acknowledged product

**Retrofits:** Best 3L. **Standard function:** Key removable in locked or unlocked position. Standard locks are non-handed. **Includes:** All parts to convert between door/drawer function and to convert to key-retaining function. **Key-retaining:** Key removable in locked position only. For factory configured key-retaining locks, specify the key-retaining part-numbers below. **Handing:** See chart on page 5 for proper handing of locks (vertical or inverted). **SP1 option:** Includes prong driver with short pins for use with Sargent XC and Marks high security cylinders. **Packed 10 per box.**

Item	Finish	Fits Mat.	Description	Weight	Price Each	
721DW	26D, US26, US3	1-1/4"	IC drawer lock body	6.1 lbs/box	\$67.60	
721DW-SP1	26D, US26, US3	1-1/4"	IC drawer lock body (with short prongs)	6.1 lbs/box	\$77.34	
721DW-138	26D	1-3/8"	IC drawer lock body	5.8 lbs/box	\$69.56	
721DW	10B, US19	1-1/4"	IC drawer lock body	6.1 lbs/box	\$81.62	
721DW-SP1	10B, US19	1-1/4"	IC drawer lock body (with short prongs)	6.1 lbs/box	\$100.44	
<b>Drawer long bolt:</b> For long bolt #721-1-LB factory installed in lock (specify -LB option). Bolts available separately for \$13.05 list price each. Extends bolt projection to 1-1/2".					<b>Add on price</b>	<b>\$20.06</b>

### KEY-RETAINING FUNCTION (KEY REMOVABLE IN LOCKED POSITION ONLY)

Item	Finish	Fits Mat.	Description	Weight	Price Each	
721DW-KR	26D, US26, US3	1-1/4"	IC drawer lock body (key retaining)	6.1 lbs/box	\$75.36	
721DW-KRSP1	26D, US26, US3	1-1/4"	IC drawer lock body (key retain, short prongs)	6.1 lbs/box	\$85.10	
721DW-KR138	26D	1-3/8"	IC drawer lock body (key retaining)	5.8 lbs/box	\$77.32	
721DW-KR	10B, US19	1-1/4"	IC drawer lock body (key retaining)	6.1 lbs/box	\$89.38	
721DW-KRSP1	10B, US19	1-1/4"	IC drawer lock body (key retain, short prongs)	6.1 lbs/box	\$108.20	
<b>Door long bolt:</b> For long bolt #721-1-LB factory installed in lock (specify -LB option). Bolts available separately for \$13.05 list price each. Extends bolt projection to 1-1/2".					<b>Add on price</b>	<b>\$20.06</b>

**Key-retaining:** Cycle to "locked" position before inserting core.



**WARNING:** This product can expose you to chemicals including chromium, which is known to the State of California to cause cancer and birth defects or other reproductive harm. For more information go to [www.P65Warnings.ca.gov](http://www.P65Warnings.ca.gov).

## 724VR Medical Cart / File Cabinet Lock



Retrofits: Best 2P73. Includes: Red "caution" flag when unlocked. Packed 10 per box.

Item	Finish	Description	Weight	Price Each
724VR	26D	Medical cart/file cabinet lock body — vertical slot, round bolt	2.6 lbs/box	\$65.98



**WARNING:** This product can expose you to chemicals including chromium, which is known to the State of California to cause cancer and birth defects or other reproductive harm. For more information go to [www.P65Warnings.ca.gov](http://www.P65Warnings.ca.gov).

## 725MD Mortise Mount Deadbolt Locks

Shown as  
VH DRAWER



725MD

ANSI/BHMA A156.11  
Grade 1

Retrofits: Best 5L7MD. **Material thickness:** Standard lock fits up to 1-1/2" material thickness and 1-3/8" lock fits up to 1-3/4" material when mortised into the door or drawer material. **Standard function:** Key removable in locked and unlocked position. **Key-retaining:** Key removable in locked position only. **Handing:** See chart on page 5. Packed 10 per box.

Item	Finish	Fits Mat.	Description	Weight	Price Each
725MD-DR-RH	26D, US26, US3, US4	1-1/16" - 1-1/2"	RH Door	5.0 lbs/box	\$60.08
725MD-DR-LH	26D, US26, US3, US4	1-1/16" - 1-1/2"	LH Door	5.0 lbs/box	\$60.08
725MD-DW-VH	26D, US26, US3, US4	1-1/16" - 1-1/2"	VH Drawer	5.0 lbs/box	\$60.08
725MD-DW-IH	26D, US26, US3, US4	1-1/16" - 1-1/2"	IH Drawer	5.0 lbs/box	\$60.08
725MD-DW-KVH	26D, US26, US3, US4	1-1/16" - 1-1/2"	VH Drawer (key retaining)	5.0 lbs/box	\$60.08
US10B finish				Add on price	\$15.22

Item	Finish	Fits Mat.	Description	Weight	Price Each
725MD3DR-RH	26D	1-3/8" - 1-3/4"	RH Door (1-3/8" barrel)	5.7 lbs/box	\$62.89
725MD3DR-LH	26D	1-3/8" - 1-3/4"	LH Door (1-3/8" barrel)	5.7 lbs/box	\$62.89
725MD3DW-VH	26D	1-3/8" - 1-3/4"	VH Drawer (1-3/8" barrel)	5.7 lbs/box	\$62.89
725MD3DW-IH	26D	1-3/8" - 1-3/4"	IH Drawer (1-3/8" barrel)	5.7 lbs/box	\$62.89
725MD3DW-KVH	26D	1-3/8" - 1-3/4"	VH Drawer (key retaining, 1-3/8")	5.7 lbs/box	\$62.89



**WARNING:** This product can expose you to chemicals including chromium, which is known to the State of California to cause cancer and birth defects or other reproductive harm. For more information go to [www.P65Warnings.ca.gov](http://www.P65Warnings.ca.gov).

## 725ML Mortise Mount Latch Locks

Shown as  
VH DRAWER

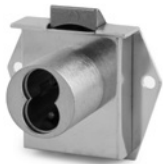

725ML

ANSI/BHMA A156.11  
Grade 1

Retrofits: Best 5L7ML. **Standard function:** Spring latch. **Key-retaining:** Key removable in locked position only. **Handing:** See chart on page 5. **Material thickness:** Standard lock fits up to 1-1/2" material thickness and 1-3/8" lock fits up to 1-3/4" material when mortised into the door or drawer material. Packed 10 per box.

Item	Finish	Fits Mat.	Description	Weight	Price Each
725ML-DR-RH	26D, US26, US3, US4	1-1/16" - 1-1/2"	RH Door	5.3 lbs/box	\$60.08
725ML-DR-LH	26D, US26, US3, US4	1-1/16" - 1-1/2"	LH Door	5.3 lbs/box	\$60.08
725ML-DW-VH	26D, US26, US3, US4	1-1/16" - 1-1/2"	VH Drawer	5.3 lbs/box	\$60.08
725ML-DW-IH	26D, US26, US3, US4	1-1/16" - 1-1/2"	IH Drawer	5.3 lbs/box	\$60.08
725ML-DWRVH	26D, US26, US3, US4	1-1/16" - 1-1/2"	VH Drawer (reverse latch)	5.3 lbs/box	\$60.08
725ML-DWRIH	26D, US26, US3, US4	1-1/16" - 1-1/2"	IH Drawer (reverse latch)	5.3 lbs/box	\$60.08
US10B finish				Add on price	\$15.22

Item	Finish	Fits Mat.	Description	Weight	Price Each
725ML3DR-RH	26D	1-3/8" - 1-3/4"	RH Door (1-3/8" barrel)	5.9 lbs/box	\$62.89
725ML3DR-LH	26D	1-3/8" - 1-3/4"	LH Door (1-3/8" barrel)	5.9 lbs/box	\$62.89
725ML3DW-VH	26D	1-3/8" - 1-3/4"	VH Drawer (1-3/8" barrel)	5.9 lbs/box	\$62.89
725ML3DW-IH	26D	1-3/8" - 1-3/4"	IH Drawer (1-3/8" barrel)	5.9 lbs/box	\$62.89
725ML3DWRVH	26D	1-3/8" - 1-3/4"	VH Drawer (reverse latch, 1-3/8")	5.9 lbs/box	\$62.89
725ML3DWRIH	26D	1-3/8" - 1-3/4"	IH Drawer (reverse latch, 1-3/8")	5.9 lbs/box	\$62.89



**WARNING:** This product can expose you to chemicals including chromium, which is known to the State of California to cause cancer and birth defects or other reproductive harm. For more information go to [www.P65Warnings.ca.gov](http://www.P65Warnings.ca.gov).

## 725RD Rim (Surface) Mount Deadbolt Locks

Shown as  
VH DRAWER



725RD

ANSI/BHMA A156.11  
Grade 1

Retrofits: Best 5L7RD. **Standard function:** Key removable in locked or unlocked position. **Key-retaining:** Key removable in locked position only. **Handing:** See chart on page 5. **Packed 10 per box.**

Item	Finish	Fits Mat.	Description	Weight	Price Each
725RD-DR-RH	26D, US26, US3, US4	1-1/16"	RH Door	5.0 lbs/box	\$60.08
725RD-DR-LH	26D, US26, US3, US4	1-1/16"	LH Door	5.0 lbs/box	\$60.08
725RD-DW-VH	26D, US26, US3, US4	1-1/16"	VH Drawer	5.0 lbs/box	\$60.08
725RD-DW-IH	26D, US26, US3, US4	1-1/16"	IH Drawer	5.0 lbs/box	\$60.08
725RD-DWKVH	26D, US26, US3, US4	1-1/16"	VH Drawer (key retaining)	5.0 lbs/box	\$60.08
US10B finish				<b>Add on price</b>	<b>\$15.22</b>

Item	Finish	Fits Mat.	Description	Weight	Price Each
725RD3DR-RH	26D	1-3/8"	RH Door (1-3/8" barrel)	5.7 lbs/box	\$62.89
725RD3DR-LH	26D	1-3/8"	LH Door (1-3/8" barrel)	5.7 lbs/box	\$62.89
725RD3DW-VH	26D	1-3/8"	VH Drawer (1-3/8" barrel)	5.7 lbs/box	\$62.89
725RD3DW-IH	26D	1-3/8"	IH Drawer (1-3/8" barrel)	5.7 lbs/box	\$62.89
725RD3DWKVH	26D	1-3/8"	VH Drawer (key retaining, 1-3/8")	5.7 lbs/box	\$62.89



**WARNING:** This product can expose you to chemicals including chromium, which is known to the State of California to cause cancer and birth defects or other reproductive harm. For more information go to [www.P65Warnings.ca.gov](http://www.P65Warnings.ca.gov).

## 725RL Rim (Surface) Mount Latch Locks

Shown as  
VH DRAWER



725RL

ANSI/BHMA A156.11  
Grade 1

Retrofits: Best 5L7RL. **Standard function:** Spring latch. **Reverse latch:** Use for in-swinging doors. **Handing:** See chart on page 5. **Packed 10 per box.**

Item	Finish	Fits Mat.	Description	Weight	Price Each
725RL-DR-RH	26D, US26, US3, US4	1-1/16"	RH Door	5.3 lbs/box	\$60.08
725RL-DR-LH	26D, US26, US3, US4	1-1/16"	LH Door	5.3 lbs/box	\$60.08
725RL-DW-VH	26D, US26, US3, US4	1-1/16"	VH Drawer	5.3 lbs/box	\$60.08
725RL-DW-IH	26D, US26, US3, US4	1-1/16"	IH Drawer	5.3 lbs/box	\$60.08
725RL-DWRVH	26D, US26, US3, US4	1-1/16"	VH Drawer (reverse latch)	5.3 lbs/box	\$60.08
725RL-DWRIH	26D, US26, US3, US4	1-1/16"	IH Drawer (reverse latch)	5.3 lbs/box	\$60.08
US10B finish				<b>Add on price</b>	<b>\$15.22</b>

Item	Finish	Fits Mat.	Description	Weight	Price Each
725RL3DR-RH	26D	1-3/8"	RH Door (1-3/8" barrel)	5.9 lbs/box	\$62.89
725RL3DR-LH	26D	1-3/8"	LH Door (1-3/8" barrel)	5.9 lbs/box	\$62.89
725RL3DW-VH	26D	1-3/8"	VH Drawer (1-3/8" barrel)	5.9 lbs/box	\$62.89
725RL3DW-IH	26D	1-3/8"	IH Drawer (1-3/8" barrel)	5.9 lbs/box	\$62.89
725RL3DWRVH	26D	1-3/8"	VH Drawer (reverse latch, 1-3/8")	5.9 lbs/box	\$62.89
725RL3DWRIH	26D	1-3/8"	IH Drawer (reverse latch, 1-3/8")	5.9 lbs/box	\$62.89



**WARNING:** This product can expose you to chemicals including chromium, which is known to the State of California to cause cancer and birth defects or other reproductive harm. For more information go to [www.P65Warnings.ca.gov](http://www.P65Warnings.ca.gov).

## 725RSL Enclosure Locks for NEMA Traffic Control Boxes

See 725RSL under **Enclosure Locks** on page 32.

# IC CORE "Best" Small Format

## 728MBL Mailbox Lock

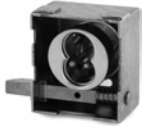

Retrofits: Best 8L. **Standard function:** Spring latch. **Handing:** See chart on page 5. **Packed 10 per box.**

Item	Finish	Fits Material	Description	Weight	Price Each
728MBL	26D	Adjustable	IC Mail Box Lock (right-hand)	2.9 lbs/box	\$51.95



**WARNING:** This product can expose you to chemicals including chromium, which is known to the State of California to cause cancer and birth defects or other reproductive harm. For more information go to [www.P65Warnings.ca.gov](http://www.P65Warnings.ca.gov).

## 729R Showcase/Ratchet Lock



Retrofits: Best 3S. **Standard function:** Key removable in locked or unlocked position. **Includes:** Ships standard with 729RS-1 strap for 1/4" panel thickness. **Packed 10 per box.**

Item	Finish	Size	Description	Weight	Price Each
729R	26D	For 1/4" panels	Ratchet lock for sliding doors	6.2 lbs/box	\$79.62

Complies with clause 6.3 (8.2-8.4) of ANSI/BHMA A156.11 ANSI standards  
Woodwork Institute (WI) acknowledged product

Item	Description	Packed	Price Each
729RS-2	Optional strap for 3/8" panel thickness	Packed Each	\$11.47
729RS-3	Optional strap for maximum 5/8", minimum 3/8" panel thickness	Packed Each	\$17.35



**WARNING:** This product can expose you to chemicals including chromium, which is known to the State of California to cause cancer and birth defects or other reproductive harm. For more information go to [www.P65Warnings.ca.gov](http://www.P65Warnings.ca.gov).

## 950IC Dead Latching Drawer Lock



**Standard function:** Spring latch with deadlocking mechanism. Turn lock 90 degrees for door function. **Includes:** Matching lip strike. **Packed 10 per box.**

Item	Finish	Fits Material	Description	Weight	Price Each
950IC	26D	1-1/8"	IC dead latching drawer lock	7.1 lbs/box	\$78.71



**WARNING:** This product can expose you to chemicals including chromium, which is known to the State of California to cause cancer and birth defects or other reproductive harm. For more information go to [www.P65Warnings.ca.gov](http://www.P65Warnings.ca.gov).

## L72V Drawer Latch Lock



**Standard function:** Spring latch. For door applications, place lock on side. **Includes:** Lip strike. **SP1 option:** Includes prong driver with short pins for use with Sargent XC and Marks high security cylinders. **Packed 10 per box.**

Item	Finish	Fits Material	Description	Weight	Price Each
L72V	26D, US3	1-1/8"	IC drawer latch lock	6.9 lbs/box	\$75.81
L72V-SP1	26D, US3	1-1/8"	IC drawer latch lock (with short prongs)	6.9 lbs/box	\$91.78



**WARNING:** This product can expose you to chemicals including chromium, which is known to the State of California to cause cancer and birth defects or other reproductive harm. For more information go to [www.P65Warnings.ca.gov](http://www.P65Warnings.ca.gov).

# CYLINDERS Small Format IC & Schlage C Keyway

## 206 & 207 SFIC Cylinders (Cores are small format Best, Arrow, Falcon compatible)



BEST compatible interchangeable core cylinders

### 206 AND 207 SERIES AVAILABLE KEYWAYS

A	B	C	D	E	F	G	H
J	K	L	M	Q	1C	1D	KMT300

### 206/207 SERIES SMALL FORMAT 6 OR 7 PIN IC CYLINDERS

Item	Description	Price Each
206(x*)-(y*)	6 pin core, uncombined	\$34.17
206(x*)-(y*)-CUST	6 pin core, KA, KD or MK	\$57.50
207(x*)-(y*)	7 pin core, uncombined	\$36.03
207(x*)-(y*)-CUST	7 pin core, KA, KD or MK	\$59.30
206/207 in US10B finish (A keyway only) add-on		\$4.41
<b>Grand master (3-level system) or systems with multiple master keys:</b> Add to the "Stock master keyed or non stock KD, KA" price. Great grand master keyed (4-level system or higher), call factory for price.		\$17.64

x\* = Specify keyway: A,B,C,D,E,F,G,H,J,K,L,M,Q,1C,1D,KMT300

y\* = Specify finish: 26D, US4

### 207S SERIES SMALL FORMAT 7 PIN IC CYLINDERS

For use with Olympus 723S sliding door cylinder housings (7-pin only).

Item	Description	Price Each
207SA-26D	7 pin glass core, A keyway, uncombined	\$47.60
207SA-26D-CUST	7 pin glass core, A keyway, KA, KD or MK	\$71.04

Stocked in A keyway. Other keyways: B,C,D,E,F,G,H,J,K,L,M,Q,1C,1D or KMT300 available by special order. Call for availability.

### PAINTED CORES (BLUE / GREEN / RED)

We can match your blue, green or red painted Best cores (7-pin only).

Item	Color	Description	Price Each
207-A-BL	BLUE	7 pin, keyed "Blue"	\$60.78
207-A-GR	GREEN	7 pin, keyed "Green"	\$60.78
207-A-RD	RED	7 pin, keyed "Red"	\$60.78

The following warning is applicable to all parts listed on this page:



**WARNING:** This product can expose you to chemicals including chromium, which is known to the State of California to cause cancer and birth defects or other reproductive harm. For more information go to [www.P65Warnings.ca.gov](http://www.P65Warnings.ca.gov).

### COMPATIBLE WITH OLYMPUS ITEMS

L72V, 720, 721, 722, 723, 724, 725, 728, 729 and 950 locks

### SPECIFICATIONS

**Cores:** Equivalent to Best, Arrow, Falcon or similar small format interchangeable cores

**Standard finish:** 26D or US4 (US10B available)

**Painted cores:** 207 (7 pin only) available in blue (BL), green (GR) or red (RD)

### KEYING INFORMATION

**Uncombined:** Core only (does not include pins, springs or keys)

**Keyed cores:** Specify KA, KD or MK.

Keyed cores include 2 change keys per core. 2 additional cut keys (master keys and/or control keys) are shipped with each order. Additional keys are available separately.

**Stamping/Engraving:** Custom stamping or engraving for cores and keys is available for an additional charge. See page 40 for details.

### KEYBLANKS & CUT KEYS

x\* = Specify keyway: A,B,C,D,E,F,G,H,J,K,L,M,Q,1C,1D,KMT300

Item	Description	Price Each
KB-400K(x*)	Keyblank for 6 or 7 pin core	\$3.53
KB-400K(x*)-CUST	Cut key for 6 or 7 pin core	\$5.24
KB-400K(x*)-CK	Cut control key for 6 or 7 pin core	\$5.24
KB-400K(x*)-MK	Cut master key for 6 or 7 pin core	\$5.24
KB-400KA-BL	Cut change key (for <b>BLUE</b> core)	\$5.24
KB-400KA-BL-CK	Cut control key (for <b>BLUE</b> core)	\$5.24
KB-400KA-GR	Cut change key (for <b>GREEN</b> core)	\$5.24
KB-400KA-GR-CK	Cut control key (for <b>GREEN</b> core)	\$5.24
KB-400KA-RD	Cut change key (for <b>RED</b> core)	\$5.24
KB-400KA-RD-CK	Cut control key (for <b>RED</b> core)	\$5.24

## 78-201 Schlage C Keyway Cylinders



SCHLAGE style C keyway replacement cylinder

Item No.	Finish	Universal Driver 10-360 Position	For use with	Keying (for US26D or US4 Cylinders)	Price Each	
78-201H26D	26D	Horizontal		KD, KA 101, 102 or 0-BIT Stock master keyed or non stock KD, KA	\$46.68	
78-201HU54	US4				\$55.43	
78-201V26D	26D	Vertical		KD, KA 101, 102 or 0-BIT Stock master keyed or non stock KD, KA	\$46.68	
78-201VU54	US4				\$55.43	
78-201-26D	26D	N/A	Not required	L78	\$46.68	
78-201-US4	US4				\$55.43	
<b>Grand master (3-level system) or systems with multiple master keys:</b> Add to the "Stock master keyed or non stock KD, KA" price. Great grand master keyed (4-level system or higher), call factory for price.					<b>Add on price</b>	<b>\$17.64</b>

**Includes:**  
2 keys per cylinder

**Keying information:**  
See page 6

**Keys & keyblanks:**  
See page 40



**WARNING:** This product can expose you to chemicals including chromium, which is known to the State of California to cause cancer and birth defects or other reproductive harm. For more information go to [www.P65Warnings.ca.gov](http://www.P65Warnings.ca.gov).

# KEYS & STAMPING CHARGES

## Keying & Stamping/Engraving Charges

For information on standard code stamping, see **Keying Information** on page 6.

Special Keying & Non-Standard Stamping/Engraving Upcharges	Add on Price Each
<b>Grand master (3-level system) or systems with multiple master keys:</b> Add to the "Stock master keyed or non stock KD, KA" price. Great grand master keyed (4-level system or higher), call factory for price.	\$17.64
<b>Great grand master keyed (4-level system or higher):</b>	Call for price
<b>Special (non-standard) code stamping/engraving cost per lock:</b> Includes special stamping face of cabinet lock and on one side of both operating keys.	\$29.77
<b>Individual component stamping/engraving:</b> Lock or SFIC cylinder face only = \$9.92 ea.   Single side of one key = \$9.92 ea.	

### N SERIES — NATIONAL KEYWAY

#### KEYBLANKS

Item	Description	Price Each
KBN-4-NP	National 4 pin keyblank (D4291)	\$2.04
KBN-5-NP	National 5 pin keyblank (D4292)	\$2.04
KBN-5B	National 5 pin keyblank (D4292) non-magnetic	\$2.04

#### CUT KEYS

Item	For National Keyway Locks	Price Each
KB-101-NP	Cut key for KA #101	\$4.42
KB-103-NP	Cut key for KA #103	\$4.42
KB-107-NP	Cut key for KA #107	\$4.42
KB-915-NP	Cut key for KA #915	\$4.42
KB-51001-NP	Cut key for KA #51001	\$4.42
KB-51002-NP	Cut key for KA #51002	\$4.42
KB-51003-NP	Cut key for KA #51003	\$4.42
KB-51004-NP	Cut key for KA #51004	\$4.42
KB-51005-NP	Cut key for KA #51005	\$4.42
KB-51006-NP	Cut key for KA #51006	\$4.42
KB-51007-NP	Cut key for KA #51007	\$4.42
KB-51008-NP	Cut key for KA #51008	\$4.42
KB-51009-NP	Cut key for KA #51009	\$4.42
KB-51010-NP	Cut key for KA #51010	\$4.42
KB-51011-NP	Cut key for KA #51011	\$4.42
KBN-4-CUST	Custom cut 4-pin key	\$4.42
KBN-5-CUST	Custom cut 5-pin key	\$4.42
KBN-5B-CUST	Custom cut 5-pin key, non-magnetic	\$4.42
KB-GM1MK-NP	National GM1 (4-pin) master key	\$4.42
KB-GM2MK-NP	National GM2 (5-pin) master key	\$4.42
KB-GM2MK-5B	National GM2 (5-pin) master key MRI	\$4.42
KB-GM3MK-NP	National GM300 (5-pin) master key	\$4.42

### R SERIES — CCL R1 KEYWAY

#### KEYBLANKS

Item	Description	Price Each
KBR-5-NP	CCL 5 pin keyblank (R1)	\$2.04
KBR-6-NP	CCL 6 pin keyblank (R1)	\$2.04
KBR-5B	CCL 6 pin keyblank (R1) non-magnetic	\$2.04

#### CUT KEYS

Item	For CCL Keyway Locks	Price Each
KB-4T2-NP	Cut key for KA #4T21579	\$4.42
KB-4T3-NP	Cut key for KA #4T37526	\$4.42
KBR-5-CUST	Custom cut 5-pin key	\$4.42
KBR-5B-CUST	Custom cut 5-pin key, non-magnetic	\$4.42
KBR-6-CUST	Custom cut 6-pin key	\$4.42
KB-R1MK-NP	Cut CCL R1 (5 pin) master key	\$4.42
KB-R1MK-5B	Cut CCL R1 (5 pin) master key MRI	\$4.42

The following warning is applicable to all parts listed on this page:

**WARNING:** This product can expose you to chemicals including chromium, which is known to the State of California to cause cancer and birth defects or other reproductive harm. For more information go to [www.P65Warnings.ca.gov](http://www.P65Warnings.ca.gov).

### KEY PROFILES

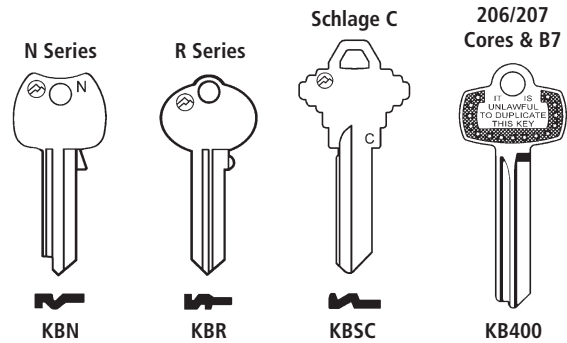

### S SERIES — SCHLAGE C KEYWAY

#### KEYBLANKS

Item	Description	Price Each
KBSC-6	Schlage "C" 6 pin keyblank	\$3.53

#### CUT KEYS

Item	For Schlage C Keyway Locks	Price Each
KB-700-101	Cut key for KA#101	\$5.24
KB-700-102	Cut key for KA#102	\$5.24
KB-700-CUST	Custom cut key Schlage C keyway	\$5.24
KB-700MK	Cut Schlage C (6-pin) master key	\$5.24

### 206/207 IC CORES & B7 CAM LOCKS

#### KEYBLANKS

Item	Description	Price Each
KB-400K(x*)	SFIC 6 or 7 pin keyblank (x*) - See page 35 for available keyways For use with small format 206/207 series IC cores or B7 series cam locks	\$3.53

#### CUT KEYS

Item	Description	Price Each
KB-400K(x*)-CUST	Cut key for 6 or 7 pin core	\$5.24
KB-400K(x*)-CK	Cut control key for 6 or 7 pin core	\$5.24
KB-400K(x*)-MK	Cut master key for 6 or 7 pin core	\$5.24
KB-400KA-BL	Cut change key (for <b>BLUE</b> core)	\$5.24
KB-400KA-BL-CK	Cut control key (for <b>BLUE</b> core)	\$5.24
KB-400KA-GR	Cut change key (for <b>GREEN</b> core)	\$5.24
KB-400KA-GR-CK	Cut control key (for <b>GREEN</b> core)	\$5.24
KB-400KA-RD	Cut change key (for <b>RED</b> core)	\$5.24
KB-400KA-RD-CK	Cut control key (for <b>RED</b> core)	\$5.24

# ACCESSORIES Wire Pulls

## PA Series Plastic Actuators



725-PA

Item	Description	Price Each
725-PA	Ships standard with small format IC locks: L72V,720,721,722,724,725, 728,729,950 locks Ships standard with Corbin/Russwin IC locks: CR1125,CR25	\$3.33
7788-PA-D	Ships standard with Schlage FSIC locks: L92V,777,888,920,929	\$3.33
931-PA	Ships standard with Medeco/Yale IC locks: 931,ME93,YA93	\$3.33



**WARNING:** This product can expose you to chemicals including chromium, which is known to the State of California to cause cancer and birth defects or other reproductive harm. For more information go to [www.P65Warnings.ca.gov](http://www.P65Warnings.ca.gov).

# SPACERS White Plastic

## Small Pin For 7/8" Barrel Diameter Locks

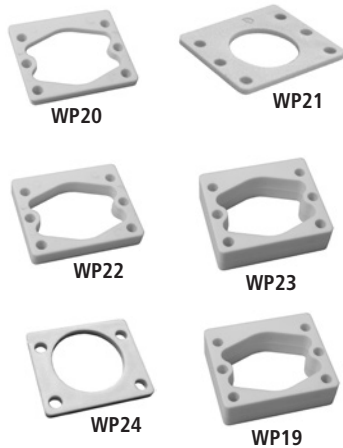

**WP21, WP22, WP23, WP24 interior spacers:** These spacers are used for flush fitting locks on various material thicknesses. They are intended for use on the interior of the cabinet door or drawer and can be stacked to create the desired thickness. **Packed each.**

Item	Finish	Description	Use With	Price Each
WP19	White Plastic	7/16" thick spacer		\$2.12
WP20	White Plastic	3/16" thick spacer		\$1.99
WP21	White Plastic	3/32" thick spacer	100, 200, 500, 600, N078, R078, L20V	\$1.91
WP22	White Plastic	1/4" thick spacer		\$2.01
WP23	White Plastic	1/2" thick spacer		\$2.12
WP24	White Plastic	1/8" thick spacer	999, 998, 997, 996	\$1.91



**WARNING:** This product can expose you to chemicals including chromium, which is known to the State of California to cause cancer and birth defects or other reproductive harm. For more information go to [www.P65Warnings.ca.gov](http://www.P65Warnings.ca.gov).

## Large Pin For 1-1/8" Barrel Diameter Locks

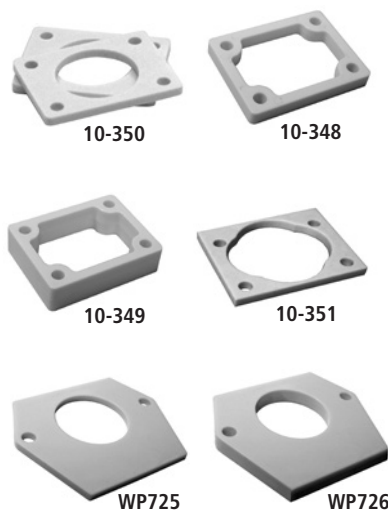

**10-348, 10-349, 10-350, & 10-351, WP725, WP726 interior spacers:** These spacers are used for flush fitting locks on various material thicknesses. They are intended for use on the interior of the cabinet door or drawer and can be stacked to create the desired thickness. **Packed each.**

Item	Finish	Description	Use With	Price Each
10-348	White Plastic	1/4" thick spacer		\$2.70
10-349	White Plastic	1/2" thick spacer	700, 721, 754, 777, 800, 850, 854, 888, 931, 950,	\$2.81
10-350	White Plastic	1/8" thick spacer	L72V, L92V	\$2.59
10-351	White Plastic	1/8" thick spacer	L78	\$2.59
WP725	White Plastic	1/8" thick spacer for	725RD, 725RL, CR1125	\$2.70
WP726	White Plastic	1/4" thick spacer for		\$2.80



**WARNING:** This product can expose you to chemicals including chromium, which is known to the State of California to cause cancer and birth defects or other reproductive harm. For more information go to [www.P65Warnings.ca.gov](http://www.P65Warnings.ca.gov).

# SPACER COLLARS

## TR200 Series For 1-1/8" Diameter Cam Locks



TR200A (PKG), TR201, TR202, TR203, TR204 trim collars: Provide forward spacing to bring lock face forward on thin material thicknesses. Packed each.

Item	Finish	Description	Use With	Price Each
TR200A	32D, US3	Trim collar package	720, 820, 920, CR25, ME93, SA54, YA93 Package includes: TR201, TR202 and TR203	\$16.67
TR201	32D, US3	1/8" trim collar	720, 820, 920, CR25, ME93, SA54, YA93	\$4.89
TR202	32D, US3	1/4" trim collar		\$5.55
TR203	32D, US3	3/8" trim collar		\$6.23
TR204	32D	5/32" trim collar	720, 820, 920, CR25, ME93, SA54, YA93	\$5.11



**WARNING:** This product can expose you to chemicals including chromium, which is known to the State of California to cause cancer and birth defects or other reproductive harm. For more information go to [www.P65Warnings.ca.gov](http://www.P65Warnings.ca.gov).

## TRB7 Series For 3/4" Diameter Cam Locks



TRB7-18, TRB7-14, TRB7-12 trim collars: Provide forward spacing to bring lock face forward on thin material thicknesses. Use with: 3/4" diameter DCN/DCR/B7 cam locks. Packed each.

Item	Finish	Description	Use With	Price Each
TRB7-18	26D	1/8" trim collar	DCN, DCR, B7 cam locks	\$4.14
TRB7-14	26D	1/4" trim collar		\$5.13
TRB7-12	26D	1/2" trim collar		\$5.95



**WARNING:** This product can expose you to chemicals including chromium, which is known to the State of California to cause cancer and birth defects or other reproductive harm. For more information go to [www.P65Warnings.ca.gov](http://www.P65Warnings.ca.gov).

# TRIM RINGS

## Trim Rings For 7/8" Barrel Diameter Locks



Fits: 7/8" diameter cabinet locks. **Function:** Covers up unevenly drilled holes or other flaws around the hole site. Packed each.

Item	Finish	Description / Use with	Price Each
TR1256	26D, US4	Trim ring for 7/8" diameter cabinet locks: 100, 200, 500, 600, 996, 997, 998, 999, L20V, N078, R078	\$4.17
TR1256	10B, US19		\$4.92



**WARNING:** This product can expose you to chemicals including chromium, which is known to the State of California to cause cancer and birth defects or other reproductive harm. For more information go to [www.P65Warnings.ca.gov](http://www.P65Warnings.ca.gov).

## Trim Rings For 1-1/8" Barrel Diameter Locks



Fits: 1-1/8" diameter cabinet locks. **Function:** Covers up unevenly drilled holes or other flaws around the hole site. Packed each.

Item	Finish	Description / Use with	Price Each
TR78	26D, US3	Trim ring for 1-1/8" diameter cabinet locks: 700, 721, 725, CR1125, 754, 777, 800, 850, 854, 888, 931, 950, L72V, L78, L92V	\$4.53
TR78	10B, US19		\$5.36



**WARNING:** This product can expose you to chemicals including chromium, which is known to the State of California to cause cancer and birth defects or other reproductive harm. For more information go to [www.P65Warnings.ca.gov](http://www.P65Warnings.ca.gov).

# THROUGH-BOLT Mounting Hardware

## Small Pin For 7/8" Barrel Diameter Locks



ETS2 / ETST2  
Through-bolt plate & spacer/template



ETS2-PL  
Cabinet Pull

ETS2: Through-bolt mounting plate is for use on the exterior of the cabinet door or drawer and provide through-bolt mounting of cabinet locks for a more secure installation. ETST2: Spacer/template is 1/8" thick and can be used either behind the ETS through-bolt plate on the front of the cabinet or between the cabinet lock body and the cabinet material on the inside of the cabinet or drawer. ETS2-PL: Is installed on the cabinet face and serves as a cabinet pull in either door or drawer applications. Packed each.

Item	Finish	Thickness	Description / Use with	Price Each
ETS2-PL	26D, US3	1/8"	Cabinet pull for 100, 200, 500, 600, L20V	\$11.47
ETS2-125	26D, US3	1/8"	Through-bolt plate for 100, 200, 500, 600, L20V	\$10.60
ETS2-250	26D, US3	1/4"	Through-bolt plate for 100, 200, 500, 600, L20V	\$10.60
ETST2	26D, US3	1/8"	Spacer/template for ETS2 and ETS2-PL	\$4.34



**WARNING:** This product can expose you to chemicals including chromium, which is known to the State of California to cause cancer and birth defects or other reproductive harm. For more information go to [www.P65Warnings.ca.gov](http://www.P65Warnings.ca.gov).



ETS2-PL installed  
with lock

## Large Pin For 1-1/8" Barrel Diameter Locks

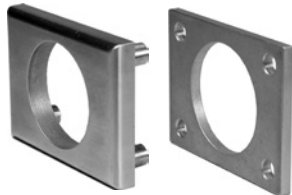

ETS1 / ETST1  
Through-bolt plate & spacer/template



ETS1-PL  
Cabinet Pull

ETS1: Through-bolt mounting plate is for use on the exterior of the cabinet door or drawer and provide through-bolt mounting of cabinet locks for a more secure installation. ETST1: Spacer/template is 1/8" thick and can be used either behind the ETS through-bolt plate on the front of the cabinet or between the cabinet lock body and the cabinet material on the inside of the cabinet or drawer. ETS1-PL: Is installed on the cabinet face and serves as a cabinet pull in either door or drawer applications. Packed each.

Item	Finish	Thickness	Description / Use with	Price Each
ETS1-PL	26D, US3	1/8"	Cabinet pull (requires use of ETS1-125 or ETS1-250) for 700, 721, 754, 777, 800, 850, 854, 888, 931, 950, L72V, L92V	\$11.47
ETS1-125	26D, US3	1/8"	Through-bolt plate for 700, 721, 754, 777, 800, 850, 854, 888, 931, 950, L72V, L92V	\$10.60
ETS1-250	26D, US3	1/4"	Through-bolt plate for 700, 721, 754, 777, 800, 850, 854, 888, 931, 950, L72V, L92V	\$10.60
ETST1	26D, US3	1/8"	Spacer/template for ETS1, ETS1-PL	\$4.34



**WARNING:** This product can expose you to chemicals including chromium, which is known to the State of California to cause cancer and birth defects or other reproductive harm. For more information go to [www.P65Warnings.ca.gov](http://www.P65Warnings.ca.gov).



ETS1-PL installed  
with lock

# STRIKES

## Small Pin For 7/8" Barrel Diameter Locks

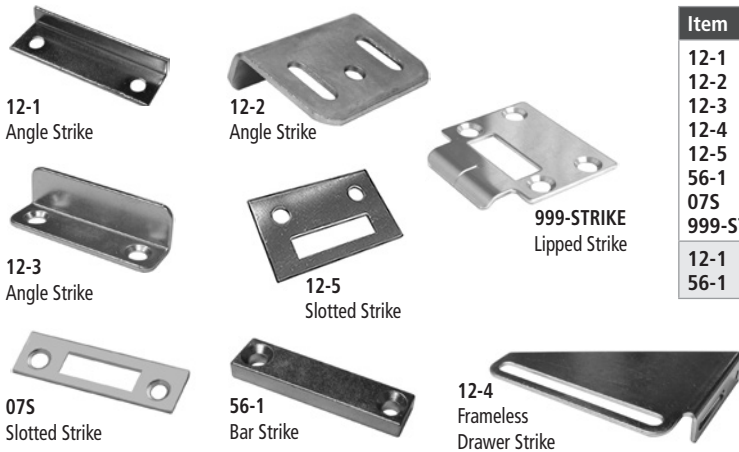

Item	Finish	Description	Price Each
12-1	26D, US4	Small angle strike	\$2.44
12-2	26D	Heavy duty angle strike	\$2.59
12-3	26D	Medium angle strike	\$2.44
12-4	ZP	Frameless drawer strike (zinc plated)	\$9.11
12-5	SS	Heavy duty slotted strike	\$3.44
56-1	26D, US4	Bar strike	\$2.44
07S	26D, US4	Slotted strike	\$2.53
999-STRIKE	US3	Lipped strike	\$2.95
12-1	10B	Small angle strike / US10B finish	\$5.88
56-1	10B	Bar strike / US10B finish	\$5.88

**WARNING:** This product can expose you to chemicals including chromium, which is known to the State of California to cause cancer and birth defects or other reproductive harm. For more information go to [www.P65Warnings.ca.gov](http://www.P65Warnings.ca.gov).

## Large Pin For 1-1/8" Barrel Diameter Locks

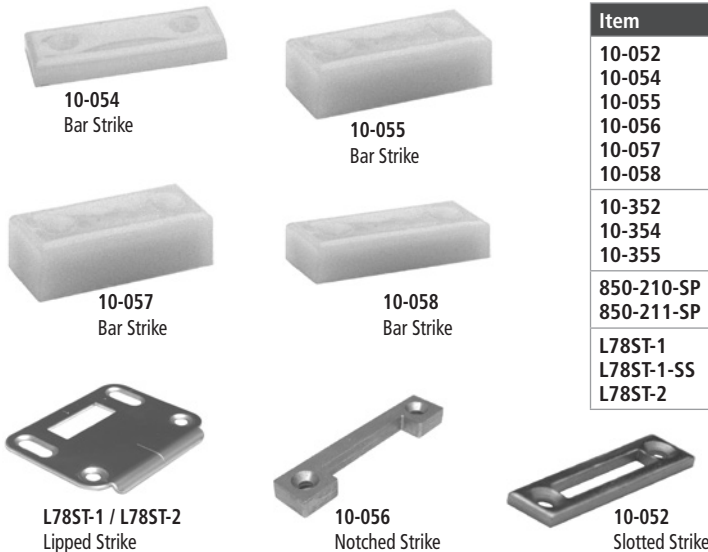

Item	Finish	Description	Price Each
10-052	26D	Slotted strike	\$2.88
10-054	White Plastic	1/4" bar strike	\$2.88
10-055	White Plastic	1/2" bar strike	\$2.88
10-056	26D	Notched strike	\$2.88
10-057	White Plastic	0.65" bar strike	\$2.88
10-058	White Plastic	3/8" bar strike	\$2.88
10-352	26D	<b>Screw pack:</b> 10-052 slotted strike + screws	\$3.18
10-354	White Plastic	<b>Screw pack:</b> 10-054 1/4" bar strike + screws	\$3.18
10-355	White Plastic	<b>Screw pack:</b> 10-055 1/2" bar strike + screws	\$3.18
850-210-SP	US4	Lipped strike for 850/950 (1-1/8 barrel length)	\$7.58
850-211-SP	US4	Lipped strike for 850 (1-3/8" barrel length)	\$7.58
L78ST-1	US3	Lipped strike for L78 (1-1/8" barrel length)	\$3.69
L78ST-1-SS	Stainless Steel	Lipped strike for L72V, L92V (1-3/8" barrel length)	\$3.69
L78ST-2	US3	Lipped strike for L78 (1-3/8" barrel length)	\$3.69

**WARNING:** This product can expose you to chemicals including chromium, which is known to the State of California to cause cancer and birth defects or other reproductive harm. For more information go to [www.P65Warnings.ca.gov](http://www.P65Warnings.ca.gov).

## IC Core For 725/CR1125 Series Locks

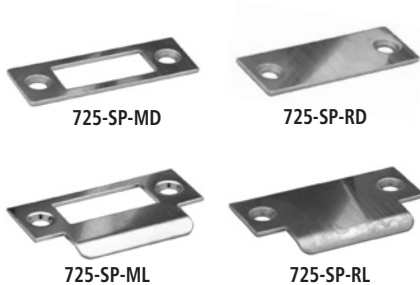

Item	Finish	Description	Use With	Price Each
725-SP-MD-US3	US3	<b>Screw pack:</b> Slotted strike + screws	Mortise Deadbolt	\$4.09
725-SP-MD-SS	Stainless Steel	<b>Screw pack:</b> Slotted strike + screws		\$4.09
725-SP-ML-US3	US3	<b>Screw pack:</b> Slotted lip strike + screws	Mortise Latch	\$4.09
725-SP-ML-SS	Stainless Steel	<b>Screw pack:</b> Slotted strike + screws		\$4.09
725-SP-RD-US3	US3	<b>Screw pack:</b> Flat strike + screws	Rim Deadbolt	\$4.09
725-SP-RD-SS	Stainless Steel	<b>Screw pack:</b> Flat strike + screws		\$4.09
725-SP-RL-US3	US3	<b>Screw pack:</b> Flat lipped strike + screws	Rim Latch	\$4.09
725-SP-RL-SS	Stainless Steel	<b>Screw pack:</b> Flat lipped strike + screws		\$4.09

**WARNING:** This product can expose you to chemicals including chromium, which is known to the State of California to cause cancer and birth defects or other reproductive harm. For more information go to [www.P65Warnings.ca.gov](http://www.P65Warnings.ca.gov).

# CABINET HARDWARE & TOOLS

## Elbow Catch & Slide Bolt



Elbow Catch

Item	Description	Price Each
EC-1-26D	Elbow catch and strike components bulk packed separately without mounting screws	\$4.28
EC-2-26D	Elbow catch and strike packaged individually with mounting screws	\$4.60
EC-TEM	Elbow catch installation template	\$6.99

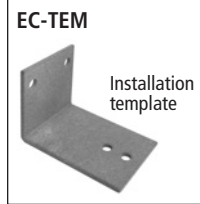

EC-TEM

Installation template



**WARNING:** This product can expose you to chemicals including chromium, which is known to the State of California to cause cancer and birth defects or other reproductive harm. For more information go to [www.P65Warnings.ca.gov](http://www.P65Warnings.ca.gov).



Slide Bolt

Item	Description	Price Each
SB-3-US26	3" Slide Bolt (Distributor Pack), packaged individually with 4 screws	\$8.94



**WARNING:** This product can expose you to chemicals including chromium, which is known to the State of California to cause cancer and birth defects or other reproductive harm. For more information go to [www.P65Warnings.ca.gov](http://www.P65Warnings.ca.gov).

## 102 Series Wire Pulls



Oval Wire Pull can be mounted for use with doors or drawers

Use: Wire pulls can be mounted on small or large pin Olympus 2000 handles or used as standard door/drawer pulls on wood or laminate cabinetry. **Packed each.**

Item	Finish	Description	Price Each
102-015-96SC	26D	3-3/4" satin chrome, oval wire pull	\$7.51
102-015-96	US3	3-3/4" polished brass, oval wire pull	\$7.51
102-015-96-10B	10B	3-3/4" oil rubbed bronze, oval wire pull	\$12.75
102-015-45C	26D	4" satin chrome, oval wire pull	\$7.51



**WARNING:** This product can expose you to chemicals including chromium, which is known to the State of California to cause cancer and birth defects or other reproductive harm. For more information go to [www.P65Warnings.ca.gov](http://www.P65Warnings.ca.gov).

## CL-HIT-25 Cabinet Lock Drill Guide



**Includes:** Four sizes of drill bushings: 3/4", 7/8", 1-1/8" and 1-1/4". For use with Forstner type drill bits. Not compatible with hole saws, paddle or spade type bits.

Item	Description	Price Each
CL-HIT-25	Cabinet Lock Drilling Guide	\$394.47



**WARNING:** This product can expose you to chemicals including chromium, which is known to the State of California to cause cancer and birth defects or other reproductive harm. For more information go to [www.P65Warnings.ca.gov](http://www.P65Warnings.ca.gov).

## CL-MP-118 Double-D Metal Punch (for 1-1/8" diameter cam locks)



**Usage:** Punches a DOUBLE "D" hole in sheet metal cabinet drawers and doors. Use on metal cabinets or any type of sheet metal door made with 18 gauge (.048) or lighter steel. Punches a DOUBLE "D" hole size 7/8" wide by 1-1/8" high. For use with 1-1/8" diameter Olympus cabinet locks 720, 820, 920, CR25, ME93, SA54, YA93.

Item	Description	Price Each
CL-MP-118	Double-D Metal Punch - for 1-1/8" diameter cam locks	\$457.64



**WARNING:** This product can expose you to chemicals including chromium, which is known to the State of California to cause cancer and birth defects or other reproductive harm. For more information go to [www.P65Warnings.ca.gov](http://www.P65Warnings.ca.gov).

# KEYING KITS

## Keying/Pin Kits For N Series & R Series Cabinet Locks



Made in USA

Item	Description	Qty/Pkg	Weight	Price Each
<b>N1</b> Use with N Series	N1 Keying Kit (includes metal box) For Olympus N Series National D4291/D4292 keyway <b>Includes:</b> 100 ea. Drivers 1-4, 100 ea. Master drivers 2-9, 100 ea. Tumblers 0-9, 100 ea. Tumbler springs, 10 ea. Set screws, 1 ea. Plug follower	Kit	5.5 ea.	\$280.06
<b>R1</b> Use with R Series	R1 Keying Kit (includes metal box) For Olympus R Series CCL R1 keyway <b>Includes:</b> 100 ea. Master pins 2-9, 100 ea. Bottom pins 0-9, 100 ea. Drivers 0 & 5, 100 ea. Tumbler springs, 10 ea. Set screws, 1 ea. Plug follower	Kit	5.5 ea.	\$280.06
Extra pins for key kits	Specify keyway and pins required (bags of 100) See chart below for individual pin part-numbers	100/bag		\$17.10
<b>OC3737</b>	Tumbler springs for N or R series locks (bags of 100)	100/bag		\$17.10
<b>S100</b>	Set screws for N or R series locks	Each		\$0.62
<b>FL1</b>	Plug follower for N or R series locks	Each	0.034 ea.	\$18.72

### N SERIES National D4291/D4292 keyway pins

Pin Item	Description	Qty/pkg	Price/pkg
OC3730	Driver #1	100/bag	\$17.10
OC3731	Driver #2	100/bag	\$17.10
OC3732	Driver #3	100/bag	\$17.10
OC3733	Driver #4	100/bag	\$17.10
OC3740	Master driver #2	100/bag	\$17.10
OC3741	Master driver #3	100/bag	\$17.10
OC3742	Master driver #4	100/bag	\$17.10
OC3743	Master driver #5	100/bag	\$17.10
OC3744	Master driver #6	100/bag	\$17.10
OC3745	Master driver #7	100/bag	\$17.10
OC3746	Master driver #8	100/bag	\$17.10
OC3747	Master driver #9	100/bag	\$17.10
OC3750	Tumbler #0	100/bag	\$17.10
OC3751	Tumbler #1	100/bag	\$17.10
OC3752	Tumbler #2	100/bag	\$17.10
OC3753	Tumbler #3	100/bag	\$17.10
OC3754	Tumbler #4	100/bag	\$17.10
OC3755	Tumbler #5	100/bag	\$17.10
OC3756	Tumbler #6	100/bag	\$17.10
OC3757	Tumbler #7	100/bag	\$17.10
OC3758	Tumbler #8	100/bag	\$17.10
OC3759	Tumbler #9	100/bag	\$17.10

### R SERIES CCL R1 keyway pins

Pin Item	Description	Qty/pkg	Price/pkg
X025	Master pin #2	100/bag	\$17.10
X038	Master pin #3	100/bag	\$17.10
X050	Master pin #4	100/bag	\$17.10
X063	Master pin #5	100/bag	\$17.10
X075	Master pin #6	100/bag	\$17.10
X088	Master pin #7	100/bag	\$17.10
X100	Master pin #8	100/bag	\$17.10
X113	Master pin #9	100/bag	\$17.10
W111	Bottom pin #0	100/bag	\$17.10
W123	Bottom pin #1	100/bag	\$17.10
W136	Bottom pin #2	100/bag	\$17.10
W148	Bottom pin #3	100/bag	\$17.10
W161	Bottom pin #4	100/bag	\$17.10
W173	Bottom pin #5	100/bag	\$17.10
W186	Bottom pin #6	100/bag	\$17.10
W198	Bottom pin #7	100/bag	\$17.10
W210	Bottom pin #8	100/bag	\$17.10
W223	Bottom pin #9	100/bag	\$17.10
X155	Driver #0	100/bag	\$17.10
X088	Driver #5	100/bag	\$17.10

## Keying Kit For Cascade Series Disc Tumbler Locks



Item	Description	Qty/Pkg	Price Each
<b>D1</b> Use with Cascade Series Disc Locks	D1 Keying Kit (includes plastic box) For Olympus Cascade Series disc tumbler <b>Includes:</b> 100 each: Disc #00, #22, #44, #66 100 each: Master disc #02, #04, #20 #24, #26, #40, #44 250 each: Disc springs	Kit	\$113.43

### CASCADE SERIES Replacement Discs and Springs for D1 Keying Kit

Item	Description	Keying	Qty/pkg.	Price/pkg
OC6782	#00 Disc (non MK)	Use for non-master keyed locks	150	\$27.31
OC6783	#22 Disc (non MK)		150	\$27.31
OC6784	#44 Disc (non MK)		150	\$27.31
OC6785	#66 Disc (non MK)		150	\$27.31
OC6786	#02 Disc (MK)	Use for mas- ter keyed locks	150	\$27.31
OC6787	#04 Disc (MK)		150	\$27.31
OC6789	#20 Disc (MK)		150	\$27.31
OC6790	#24 Disc (MK)		150	\$27.31
OC6791	#26 Disc (MK)		150	\$27.31
OC6792	#40 Disc (MK)		150	\$27.31
OC6793	#44 Disc (MK)		150	\$27.31
OC6798	Disc spring		250	\$40.97

The following warning is applicable to all parts listed on this page:



**WARNING:** This product can expose you to chemicals including chromium, which is known to the State of California to cause cancer and birth defects or other reproductive harm. For more information go to [www.P65Warnings.ca.gov](http://www.P65Warnings.ca.gov).

# DISPLAY BOARDS & SAMPLE KITS

## FDB Series Olympus Display Boards

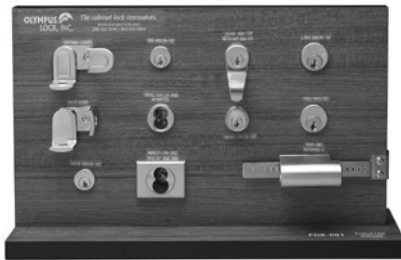

FDB-001



FDB-010



FDB-002



FDB-003



FDB-004



FDB-005



FDB-006

Item	Description	Price Each
FDB-001	Sample board includes large pin, small pin, interchangeable core and padlockable cam lock <b>Includes the following locks:</b> DCP500, 100DR, DCN2 w/DCNP pull, L78V, DCP, 725RL, 300SD, 700S, N078, 888, 729R w/729RS-3	\$372.79
FDB-002	Sample board for small pin locks <b>Includes the following locks:</b> 100DR, 200DW w/ETS2, 998V, N078, 300SD, DCN1	\$329.78
FDB-003	Sample board for large pin locks <b>Includes the following locks:</b> 700S, L92V w/ETS1, 800S, 820SC w/TR203, 777, 920 w/TR203	\$329.78
FDB-004	Sample board for interchangeable core locks <b>Includes the following locks:</b> L72V, 721DW w/ETS1, 721DR, 720, 725RD, 722S	\$329.78
FDB-005	Sample board stick <b>Includes the following locks:</b> 720 w/TR203, 721DW w/ETS1, DCN1, 100DR, DCP500	\$280.76
FDB-006	Sample board stick <b>Includes the following locks:</b> DCN, 100DR w/ETS2, DCP500	\$218.77
FDB-010	Sample board for Cascade Series cam locks (can stand or hang) <b>Includes the following locks:</b> 953, 954, 955, 960, 961	\$148.82



**WARNING:** This product can expose you to chemicals including chromium, which is known to the State of California to cause cancer and birth defects or other reproductive harm. For more information go to [www.P65Warnings.ca.gov](http://www.P65Warnings.ca.gov).

## SK Series Product Sample & Service Kits



**SK-002** Contains a broad sampling of our best selling locks and accessories. The kit comes in its own plastic, 2 level case with each product carefully marked and separated by dividers.

**SK-003** Contains a broad sampling of our small format interchangeable core (SFIC) cabinet locks and accessories. The kit comes in its own plastic, 2 level case with each product carefully marked and separated by dividers.

**SK-004** Contains a sampling of our most popular parts and accessories. The kit comes in its own plastic, 2 level case with parts marked and separated by dividers. Provides additional room for extra locks and accessories.

Item	Description	Price Each
SK-002	<b>General Product Line</b> See list of contents: <a href="http://olympuslock.com/sk-002.htm">olympuslock.com/sk-002.htm</a>	\$729.24
SK-003	<b>Small Format IC Core</b> See list of contents: <a href="http://olympuslock.com/sk-003.htm">olympuslock.com/sk-003.htm</a>	\$729.24
SK-004	<b>Parts Kit</b> See list of contents: <a href="http://olympuslock.com/sk-004.htm">olympuslock.com/sk-004.htm</a>	\$199.33
SK-005	<b>N Series Locks</b> See list of contents: <a href="http://olympuslock.com/sk-005.htm">olympuslock.com/sk-005.htm</a>	\$729.24
SK-006	<b>Schlage C Keyway Locks</b> See list of contents: <a href="http://olympuslock.com/sk-006.htm">olympuslock.com/sk-006.htm</a>	\$729.24



**WARNING:** This product can expose you to chemicals including chromium, which is known to the State of California to cause cancer and birth defects or other reproductive harm. For more information go to [www.P65Warnings.ca.gov](http://www.P65Warnings.ca.gov).

**SK-005** Contains a sampling of our N Series (National Keyway) cabinet locks and accessories. The kit comes in its own plastic, 2 level case with each product carefully marked and separated by dividers.

**SK-006** Contains a sampling of our Schlage C Keyway cabinet locks and accessories. The kit comes in its own plastic, 2 level case with each product carefully marked and separated by dividers.

# ADDITIONAL Parts & Accessories

## FOR DCN/DCR/B7/T37

Item	Description	Price Each
B7-TS	Pin cover/top slide for B7	\$1.06
DCNP-GW	Glass mounting washer	\$1.41
DCNP-RS	Plug retainer staple DCN/DCR/T37	\$1.12
DCNP-SL	Pin cover/top slide for DCN/DCR	\$1.06
DCNP-SPW	Pronged wood washer	\$1.06
P95-SPW	Eyelet pronged wood washer (NEW)	\$1.07
DCNP-200- OCD	Outer cam driver	\$2.25
DCNP-200-RCS	Reverse cam stop	\$2.25
DCNP-300-FP	Finger pull, stainless steel	\$2.95
S200-ZP-LT	Machine screw	\$1.12
DCNP-600-NUT	Brass fixing nut	\$5.55
DCNP-200-KR	Key retaining driver-drawer	\$2.25
DCNP-200-KDR	Key retaining driver-door	\$2.25
DCNP-500-ARP	Anti rotation plate	\$1.17

## FOR N SERIES & R SERIES LOCKS

Item	Description	Price Each
1256-3	Cylinder washer, 100/200/500/600	\$1.11
1256-4-78	Pin cover, 100/200/500/600, 7/8"	\$1.11
1256-4-138	Pin cover, 100/200/500/600, 1-3/8"	\$1.11
07834C-1	Pin cover for 300/400/N078/R078	\$1.11
15-1-35	Extended bolt for 100/500	\$12.65
15-2	100/500 bolt driver (standard function)	\$1.77
15-2KR	100/500 key-retaining bolt driver	\$1.77
26-2	200/600 bolt driver (standard function)	\$1.77
26-2KR	200/600 key-retaining bolt driver	\$1.77
S160	Stop screw for 300/400	\$1.12
34-9	Strike bushing for 300/400	\$2.23
S170	Bolt extender for 300/400	\$2.95
S120-SS	Strike screw #6 x 1/2" SS (MRI)	\$0.62
S125-SS	Lock mounting screw #6 x 1" SS (MRI)	\$0.62
S130-UB	Assembly screw (100/200/500/600) (MRI)	\$1.12

## FOR 700 & 800

Item	Description	Price Each
10-361	Driver bar for 7/8"	\$2.01
10-361-KR	Driver bar for 7/8" (key-retaining)	\$2.01
10-362	Driver bar for 1-3/8"	\$2.01
10-362-KR	Driver bar for 1-3/8" (key-retaining)	\$2.01
10-363	Driver bar, Medeco	\$2.01
10-364	Driver bar, ASSA	\$2.01
10-360	Universal driver	\$1.63
10-112	Bolt driver, ASSA (700LC)	\$7.85
10-212	Bolt driver, ASSA (800LC)	\$7.85
78-KABA-CONV	Kit for KABA cylinders (for 700LC/800LC)	\$7.47
S190	Set screw	\$1.12

## 777 & 888 SERIES

Item	Description	Price Each
7788-PA-13	Plastic actuator, for key retaining	\$3.33
7788-PA-24	Plastic actuator, for key retaining	\$3.33
7788-PA-D	Plastic actuator, for standard function	\$3.33

## 920 SERIES

Item	Description	Price Each
7788-PA-D	Plastic actuator, for standard function	\$3.33

## 931 SERIES

Item	Description	Price Each
931-DR-11	Door driver disk	\$7.85
931-DW-11	Drawer driver disk	\$7.85
931-PA	Plastic actuator	\$3.33
931-1	Spacer for Medeco 6-pin IC core cylinders	\$2.95

## 721 SERIES

Item	Description	Price Each
725-PA	Plastic actuator	\$3.33
721-1	Standard reversible bolt for 721	\$7.85
721-1-LB	Extended reversible bolt for 721	\$13.04
721-2	Bolt driver (lost motion or key retaining)	\$2.81
721-DR-11	Prong driver (door) for 1-1/4" lock	\$7.85
721-DW-11	Prong driver (drawer) for 1-1/4" lock	\$7.85
721-DRPD-138	Prong driver (door) for 1-3/8" lock	\$8.74
721-DWPD-138	Prong driver (drawer) for 1-3/8" lock	\$8.74
721-DR-11-SP1	Short pin prong driver (door) for 1-1/4" lock	\$7.85
721-DW-11-SP1	Short pin prong driver (drawer) for 1-1/4" lock	\$7.85
S190	Set screw	\$1.12

## CR1125/CR25 SERIES

Item	Description	Price Each
725-PA	Plastic actuator	\$3.33
1125-1	6 pin core spacer	\$1.86
CR25-PD	Short-pin prong driver (for CR25 only)	\$5.83

## 725 SERIES

Item	Description	Price Each
725-PA	Plastic actuator	\$3.33
725-1	Internal spacer for 6-pin SFIC cores	\$1.86

## 729, 829 & 929 SHOWCASE/RATCHET LOCKS

Item	Description	Price Each
729RS-1	Strap for 1/4" thick material (ships standard)	\$11.47
729RS-2	Strap for 3/8" thick material	\$11.47
729RS-3	Adjustable strap for up to 5/8" thick material	\$17.35

## 720, 820, 920, CR25, ME93, SA54, YA93 CAM LOCKS (excludes 720B-DM)

Item	Description	Price Each
720-CDLM	Cam driver, lazy motion	\$2.36
720-CDDM	Cam driver, direct motion (key-retain) door	\$2.36
720-KR	Cam driver, direct motion (key-retain) drawer	\$2.36
720-3-1	Short cam, 7/8"	\$3.46
720-3-2	Long vertical cam, 1-3/4"	\$3.46
720-3-3	Long inverted cam, 1-3/4"	\$3.46
720-3-4	Long straight cam, 3"	\$3.46
720-3-5	Long inverted bent cam	\$3.46
720-4	Brass fixing nut	\$5.55
S200-ZP-LT	Machine screw	\$1.12
S260	Threaded cam stop pin	\$1.12
720-PL3	Anti-rotation plate	\$2.77

## FOR 720LM/DM

Item	Description	Price Each
725-PA	Plastic actuator	\$3.33
725-1	Internal spacer	\$1.86
720-PD	Prong driver	\$5.83

## 720B-DM

Item	Description	Price Each
725-PA	Plastic actuator	\$3.33
720-3-D1	Short cam, direct drive	\$3.46
720-3-SC1	Switch cam, direct drive	\$4.59
720-4	Brass fixing nut	\$5.55
720-PL3	Anti-rotation plate	\$2.77

The following warning is applicable to all parts listed on this page:



**WARNING:** This product can expose you to chemicals including chromium, which is known to the State of California to cause cancer and birth defects or other reproductive harm. For more information go to [www.P65Warnings.ca.gov](http://www.P65Warnings.ca.gov).

# BRASS PADLOCKS

## CRB200 Corbin/Ruswin Interchangeable Core Padlock Bodies



Accepts Corbin Ruswin interchangeable core cylinders. **Packaged:** Packed each. **Cores/Cylinders:** Not included.

Item	Width	Shackle	Keying	Packaged	Price Each
CRB200-IC6	2" - 50mm	7/8" (25 mm) Opening Regular Shackle	Accepts Corbin/Ruswin 6-pin IC Cylinders (cylinders not included)	Each	\$66.66
CRB200-IC6-LS	2" - 50mm	2-5/8" (65 mm) Opening Long Shackle	Accepts Corbin/Ruswin 6-pin IC Cylinders (cylinders not included)	Each	\$69.06



**WARNING:** This product can expose you to chemicals including chromium, which is known to the State of California to cause cancer and birth defects or other reproductive harm. For more information go to [www.P65Warnings.ca.gov](http://www.P65Warnings.ca.gov).

# N SERIES BRASS PADLOCKS

**Keyway:** National D4291 (4-pin) or D4292 (5-pin) keyway  
**Stock KD/KA:** 4 pin standard  
**Stock KA#:** 101, 103, 107, 915  
**Stock KA#:** 51001 through 51004  
**Master keyed:** 5 pin standard  
**Pin Kit:** Use N1 Pin Kit for rekeying

**Keyblanks:** 4-pin use KBN-4-NP (equivalent to NA14, 1069L), 5-pin use KBN-5-NP (equivalent to NA12, 1069LA). See page 43 for cut keys and keyblanks.  
**Custom stamping:** See page 40.  
**Keying information:** See page 6.

## PN50 N Series National Keyway Padlocks

**Packaged:** Packed each. **Keyway:** N Series, National keyway (D4291/D4292). Can be keyed to match Olympus N Series cabinet locks.

Item	Width	Shackle	Pinning	Pin Tumbler Keying	Packaged	Price Each
PN50	2"	1-1/16" Opening Regular Shackle	4 Pin	KD, KA 101,103,107,915,51001,51002,51003,51004 Stock master keyed or non stock KD, KA	Each	\$53.00
			5 Pin			\$57.31
PN50LS	2"	2-1/16" Opening Long Shackle	4 Pin	KD, KA 101,103,107,915,51001,51002,51003,51004 Stock master keyed or non stock KD, KA	Each	\$54.86
			5 Pin			\$59.17
<b>Grand master (3-level system) or systems with multiple master keys:</b> Add to the "Stock master keyed or non stock KD, KA" price. Great grand master keyed (4-level system or higher), call factory for price.					<b>Add on price</b>	<b>\$17.64</b>

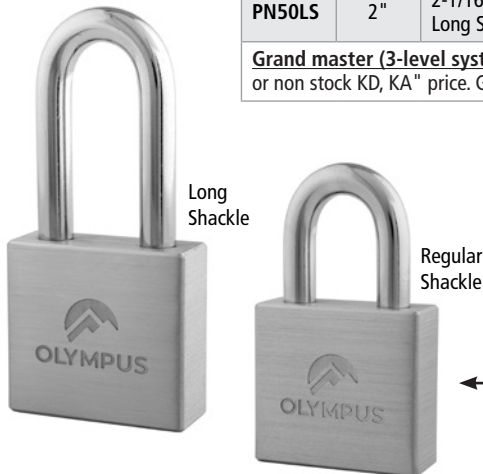

**WARNING:** This product can expose you to chemicals including chromium, which is known to the State of California to cause cancer and birth defects or other reproductive harm. For more information go to [www.P65Warnings.ca.gov](http://www.P65Warnings.ca.gov).

Match your padlocks to your N Series, National Keyway cabinet locks!

# BRASS PADLOCKS

## BP Mountain Series Blister Packed Brass Padlocks



Long Shackle

Regular Shackle

**Special note on our keyed different padlocks:** Keyed different codes are not guaranteed against interchange. **Packaged:** BP Mountain Series padlocks are sold in full box quantities only (see box quantities below).

Item	Keying	Width	Shackle	Box Qty	Case Qty	Price Each
BP075	KD or KA 30	3/4" (20mm)	Regular	10	200	\$4.61
BP100	KD or KA 40, 45	1" (25mm)	Regular	10	200	\$7.85
BP125	KD or KA 51	1-1/4" (30mm)	Regular	10	100	\$9.81
BP125LS	KD or KA 51, 59	1-1/4" (30mm)	Long	10	50	\$10.36
BP150	KD or KA 60, 61, 65	1-1/2" (40mm)	Regular	10	100	\$13.88
BP150LS	KD or KA 60, 65	1-1/2" (40mm)	Long	10	50	\$14.28
BP175	KD or KA 70, 75	1-3/4" (45mm)	Regular	5	75	\$16.28
BP200	KD or KA 80	2" (50mm)	Regular	5	75	\$22.41



**WARNING:** This product can expose you to chemicals including chromium, which is known to the State of California to cause cancer and birth defects or other reproductive harm. For more information go to [www.P65Warnings.ca.gov](http://www.P65Warnings.ca.gov).

### BP PADLOCK MEASUREMENTS

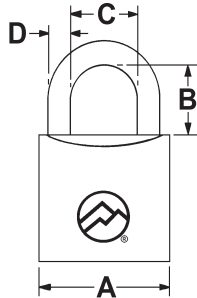

**A** = Body size

**B** = Distance between top of lock and inside shackle

**C** = Width of inside shackle

**D** = Shackle diameter

Item	A	B	C	D	Box Qty	Box Weight
BP075	3/4"	3/8"	3/8"	1/8"	10	1.1 lbs.
BP100	1"	1/2"	1/2"	5/32"	10	1.1 lbs.
BP125	1-1/4"	5/8"	5/8"	7/32"	10	2.1 lbs.
BP125-LS	1-1/4"	2-1/8"	5/8"	7/32"	10	3.1 lbs.
BP150	1-1/2"	7/8"	7/8"	1/4"	10	3.9 lbs.
BP150-LS	1-1/2"	2-1/2"	7/8"	1/4"	10	4.7 lbs.
BP175	1-3/4"	1"	1"	9/32"	5	2.9 lbs.
BP200	2"	1-1/8"	1"	11/32"	5	3.1 lbs.

**Note:** All fractional measurements are approximate.

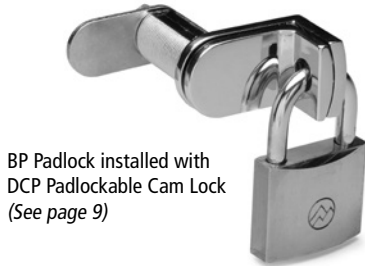

BP Padlock installed with DCP Padlockable Cam Lock (See page 9)

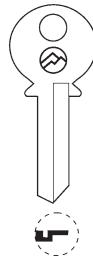

### BP (MOUNTAIN) SERIES PADLOCK KEYBLANKS

Item	Description	Packaged	Price / Box
KB220	Fits BP075 - 3/4" Padlock	50/box	\$39.52
KB225	Fits BP100 - 1" Padlock	50/box	\$39.52
KB235	Fits BP125 - 1-1/4" Padlock	50/box	\$39.52
KB240	Fits BP150 - 1-1/2" Padlock	50/box	\$39.52
KB240	Fits BP175 - 1-3/4" Padlock	50/box	\$39.52
KB250	Fits BP200 Padlock - 2" Padlock	50/box	\$57.20



**WARNING:** This product can expose you to chemicals including chromium, which is known to the State of California to cause cancer and birth defects or other reproductive harm. For more information go to [www.P65Warnings.ca.gov](http://www.P65Warnings.ca.gov).

# TERMS, CONDITIONS & WARRANTY

## CONDITIONS OF SALE

**Payment Terms:** 2% 10 days, net 30 days. All payment terms are subject to credit approval. Past due balances are subject to a late payment charge of 1.5% per month, or the maximum permitted by applicable law, whichever is less.

**Remittance Address:** All payments should be sent by mail to: Olympus Lock, Inc., PO Box 1277, Lynnwood, WA 98046

**Minimum Order:** \$40 net excluding freight. Orders of less than \$40 will be subject to a \$10 under minimum surcharge or the difference between the order value and \$40 whichever is less.

**Minimum Annual Purchases:** \$10,000 net excluding freight for open account status.

**Prices:** Olympus Lock, Inc. reserves the right to change prices and add or remove items at any time and without prior notice.

**Conditions:** All specifications are subject to withdrawal or change at any time and without prior notice. Olympus Lock reserves the right to refuse orders which may be submitted. All prices F.O.B. Lynnwood, Washington, US Funds.

## OFFICE HOURS & CONTACT INFORMATION

**Office Hours:** 7:00 AM to 4:00 PM Pacific Standard Time

**Phone:** 206-362-3290, **Toll-Free:** 800-525-0954, **Fax:** 206-362-3569

**Street Address:** 18424 Highway 99, Lynnwood, WA 98037

**Website:** [www.olympuslock.com](http://www.olympuslock.com)

**Company email:** [info@olympuslock.com](mailto:info@olympuslock.com)

## U.S. SHIPMENTS

All merchandise is shipped F.O.B. from our Lynnwood, Washington warehouse and becomes the property of the customer when accepted by the carrier. Olympus Lock will pay freight charges on orders of **\$1,500.00** net or more to a single destination within the continental U.S.A. (excluding Alaska) via the carrier of our choice. For Hawaii and Alaska Customers: Olympus will pay freight on shipments of **\$1,500** net or more to closest U.S. West Coast port.

## CANADIAN SHIPMENTS

All merchandise is shipped F.O.B. our Lynnwood, Washington warehouse and becomes the property of the customer when accepted by the carrier. Olympus Lock will pay freight charges on Canadian orders of **\$1,500** net or more to closest U.S.A. border crossing via the carrier of our choice provided this information is clearly specified at time of order. Olympus Lock will pay freight charges on Canadian orders of **\$2,000** net or more to a single Canadian destination via the carrier of our choice. All duty and/or customs charges are the sole responsibility of the customer.

## DELIVERY

Claims resulting from loss, shortages or damage-in-transit must be reported to Olympus Lock within 15 days of delivery. Any claims resulting from shortages, overages, or the shipment of incorrect products by Olympus Lock must be reported to Olympus Lock within 15 days of delivery. Olympus Lock does not assume responsibility for any damages resulting from any delays in delivery.

## REFUSED OR RETURNED SHIPMENTS

The following charges will be assessed against all refused and/or returned shipments which have not been preauthorized or which are found not the fault of Olympus Lock.

1. Customer will be billed for any return shipping fees, duty and taxes.
2. If customer wants Olympus Lock to re-ship the order, a new shipping fee will be assessed and billed at the current shipping rate.
3. All returned and/or reshipped orders are subject to a \$20.00 handling fee.
4. For authorized returns, see our Returned Goods Policy.

## CANCELLATIONS

Cancellations or alterations to orders will be accepted only when the cancellation or alteration can be made without loss to Olympus Lock. Orders for non-stock and/or custom items may not be cancelled after work has begun.

## RETURNED GOODS POLICY

No material is to be returned without our verbal or written permission in advance. All returned goods require a Returned Goods Authorization (RGA) number to be obtained from Olympus Lock prior to returning the goods. Only products purchased within the last 12 months may be returned. Any products purchased more than 12 months prior are ineligible for return. Whether goods may be returned will be at the sole discretion of Olympus Lock, Inc. Merchandise returned must be identified as to original purchase order number, date of purchase, and shipper's name and address.

A 25% restocking fee will apply to all returned goods which are found not to be the responsibility of Olympus Lock.

All goods must be shipped freight prepaid and received at our warehouse within 30 days of receiving an RGA number. Goods not received within 30 days of RGA issuance or for which an RGA number was not issued will not be returned and no credit will be issued.

Returned goods must be received in first-class resalable condition and in original factory packaging. The determination of "first-class resalable condition" will be at the sole discretion of Olympus Lock. Goods that are returned and determined by Olympus Lock not to be in first-class resalable condition will not be returned, will be scrapped at the factory, and no credit will be issued.

### The following are non-returnable:

1. Custom keyed, non-stock items
2. Goods that have been installed
3. Goods that required custom stamping
4. Goods with custom, special order finishes
5. Products or parts that have been modified
6. Obsolete or discontinued items

## LIMITED WARRANTY

Olympus Lock warrants that its products are free from defects in workmanship and materials under normal installation, use and service. This warranty does not cover defects or damages arising from improper installation, improper maintenance, ordinary wear and tear, misuse or abuse.

The only liability of the company in tort or in contract, whether under this warranty or otherwise shall be limited to repair or replacement of products which are returned prepaid to us within one year of the date of original purchase.

This is a limited warranty and is in lieu of all other representations and expressed or implied warranties. Under no circumstances shall Olympus Lock be made liable for any incidental or consequential damages or losses.

## WARNING: CALIFORNIA PROPOSITION 65 STATEMENT

This product can expose you to chemicals including lead, which is known to the State of California to cause cancer and birth defects or other reproductive harm. For more information go to [www.P65Warnings.ca.gov](http://www.P65Warnings.ca.gov).

### What is California Proposition 65?

Also known as the Safe Drinking Water and Toxic Enforcement Act of 1986, California Proposition 65 is a law that requires warning to consumers if a product exposes consumers to a wide variety of chemicals known by the State of California to cause cancer, birth defects and/or other reproductive harm. Proposition 65 applies only in California.

### What does the Proposition 65 warning mean?

A Proposition 65 warning means that the business issuing the warning knows that one or more listed chemicals is merely present in its product. A warning must be given unless a business demonstrates that the exposure it causes poses "no significant risk."

### Why does Olympus Lock place a Proposition 65 warning on its products?

A Proposition 65 warning means one of two things: (1) the company evaluated the exposure and has concluded that product exceeds the "no significant risk level"; or (2) the company has chosen to provide a warning simply based on its knowledge about the presence of a listed chemical without attempting to evaluate the exposure.

Out of an abundance of caution, Olympus Lock has elected to place the Proposition 65 warning on all products shipped to California.



# OLYMPUS<sup>®</sup> LOCK<sub>UN</sub>

18424 Highway 99 | Lynnwood, WA 98037  
206-362-3290 | 800-525-0954 | Fax 206-362-3569  
Email: [info@olympuslock.com](mailto:info@olympuslock.com)  
[www.olympuslock.com](http://www.olympuslock.com)



For more information, installation instructions,  
technical videos, or pre-written architectural  
specifications, please visit our website:  
[www.olympuslock.com](http://www.olympuslock.com)



[facebook.com/OlympusLock](https://facebook.com/OlympusLock)



[instagram.com/olympuslock](https://instagram.com/olympuslock)



[x.com/OlympusLock](https://x.com/OlympusLock)



[youtube.com/OlympusLock](https://youtube.com/OlympusLock)



[linkedin.com/company/olympus-lock-inc-](https://linkedin.com/company/olympus-lock-inc-)



enews sign up: [olympuslock.com](http://olympuslock.com)